



US00D431319S

United States Patent [19]

Hiller et al.

[11] Patent Number: **Des. 431,319**

[45] Date of Patent: **** Sep. 26, 2000**

[54] LAMP BASE

5,258,899 11/1993 Chen 362/394
5,381,323 1/1995 Osteen et al. 362/394 X

[75] Inventors: **Raymond J. Hiller**, Chapel Hill;
Michael Drake, Stoney Creek, both of
N.C.

Primary Examiner—Susan J. Lucas
Attorney, Agent, or Firm—Niro, Scavone, Haller & Niro

[73] Assignee: **Regent Lighting Corporation**,
Burlington, N.C.

[57] **CLAIM**

[**] Term: **14 Years**

We claim the ornamental design for a lamp base, as shown
and described.

[21] Appl. No.: **29/111,563**

DESCRIPTION

[22] Filed: **Sep. 30, 1999**

[51] LOC (7) Cl. **26-99**

FIG. 1 is a perspective view taken from the left side of the
new design;

[52] U.S. Cl. **D26/142; D10/106**

FIG. 2 is a top plan view thereof;

[58] Field of Search D10/106; D26/60-66,
D26/118; 362/267, 271, 272, 275, 276,
288, 427, 428, 429, 341, 345, 347, 349,
359, 361, 362, 374, 375, 383, 384, 385

FIG. 3 is a side elevational thereof;

FIG. 4 is a front elevation view thereof; and,

FIG. 5 is a bottom view thereof.

[56] **References Cited**

U.S. PATENT DOCUMENTS

D. 399,022 9/1998 Jensen et al. D26/142

1 Claim, 1 Drawing Sheet

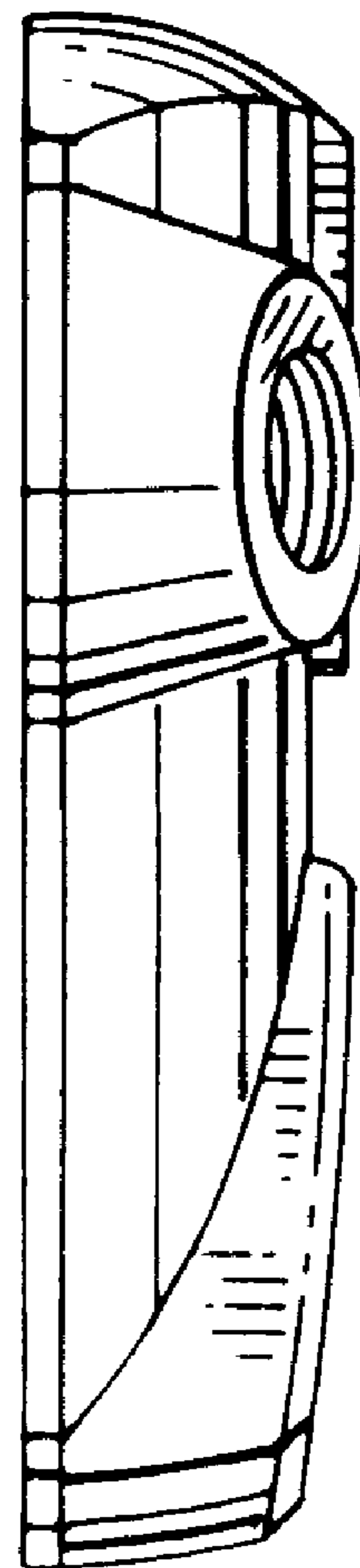
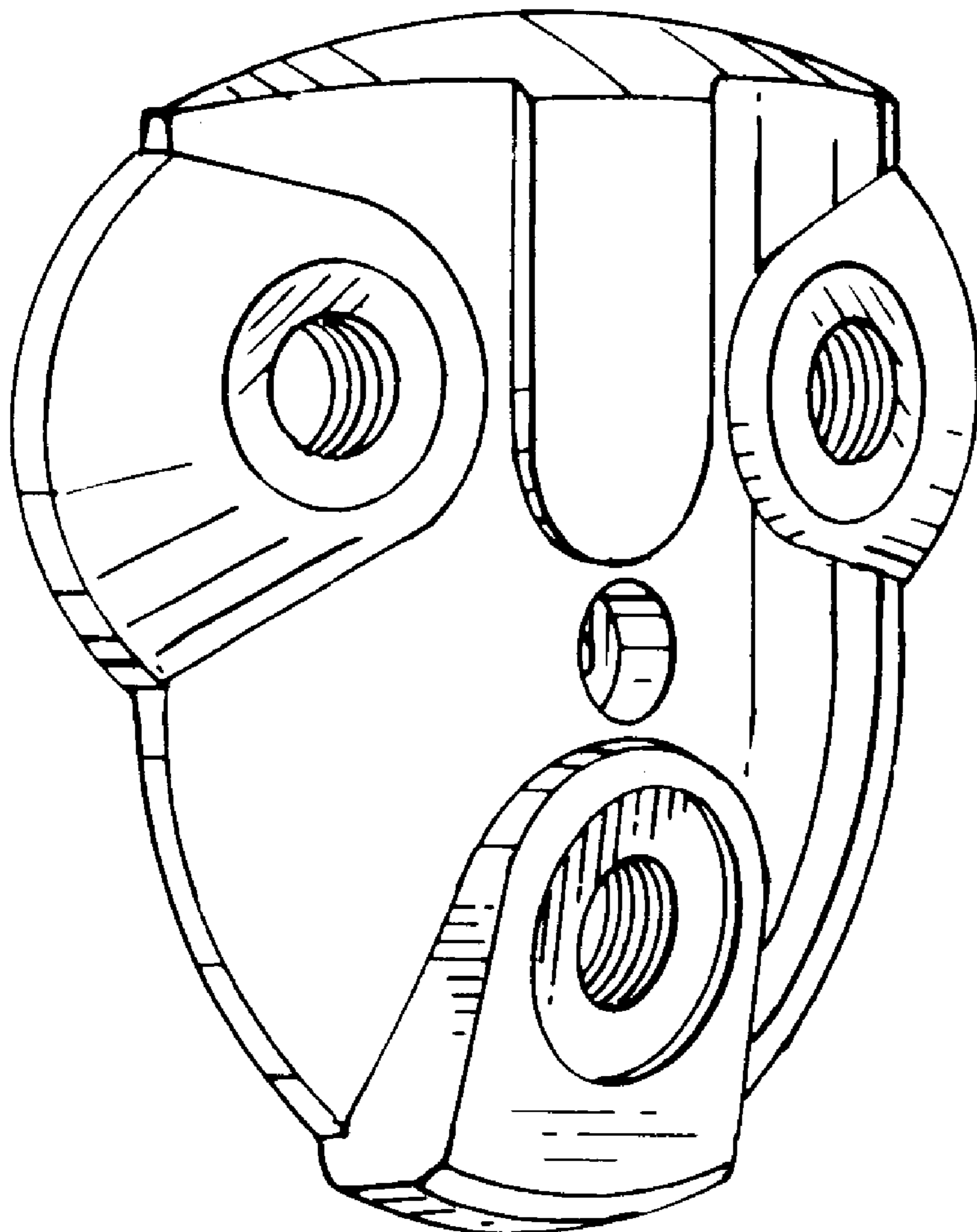

FIG. 1

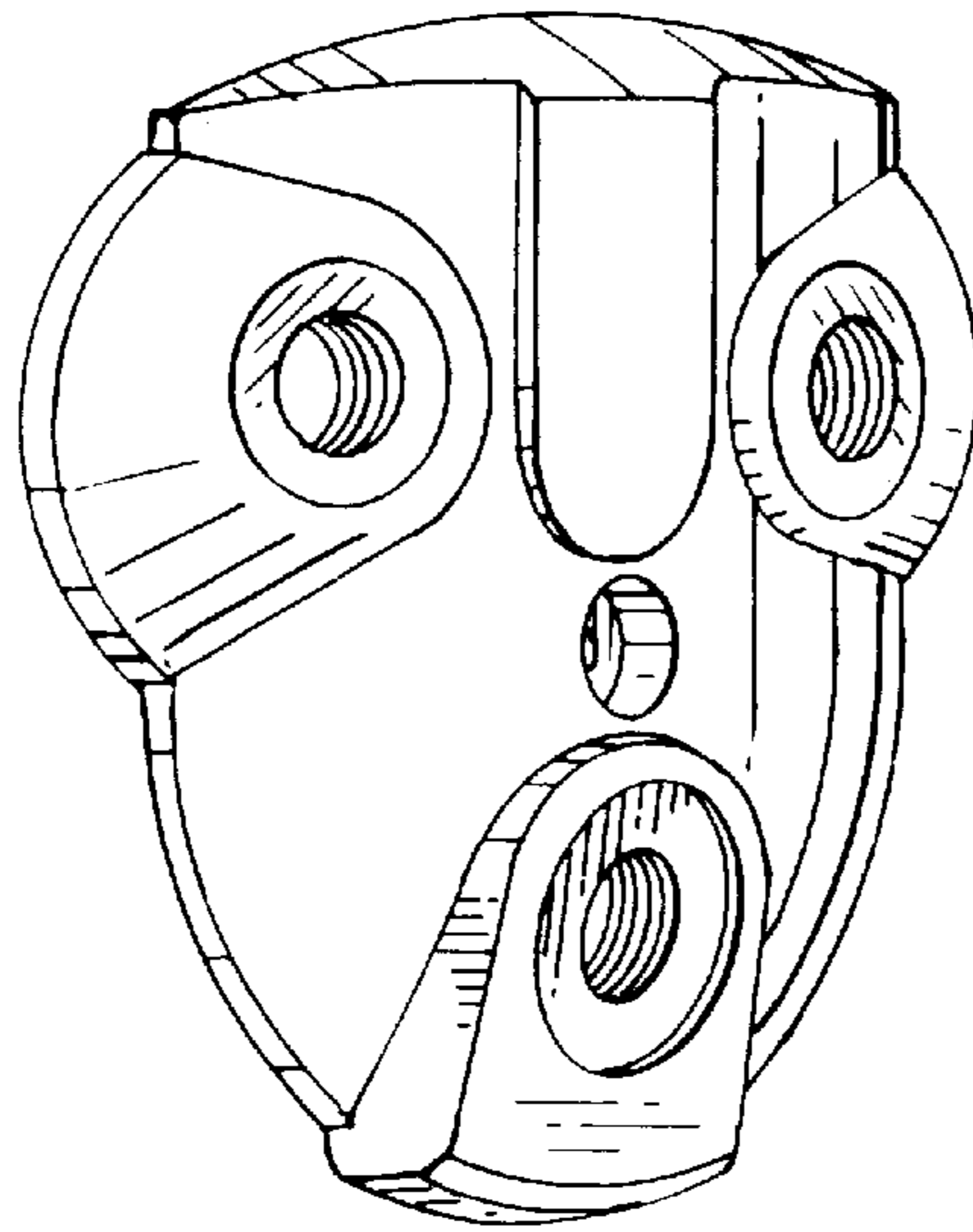

FIG. 2

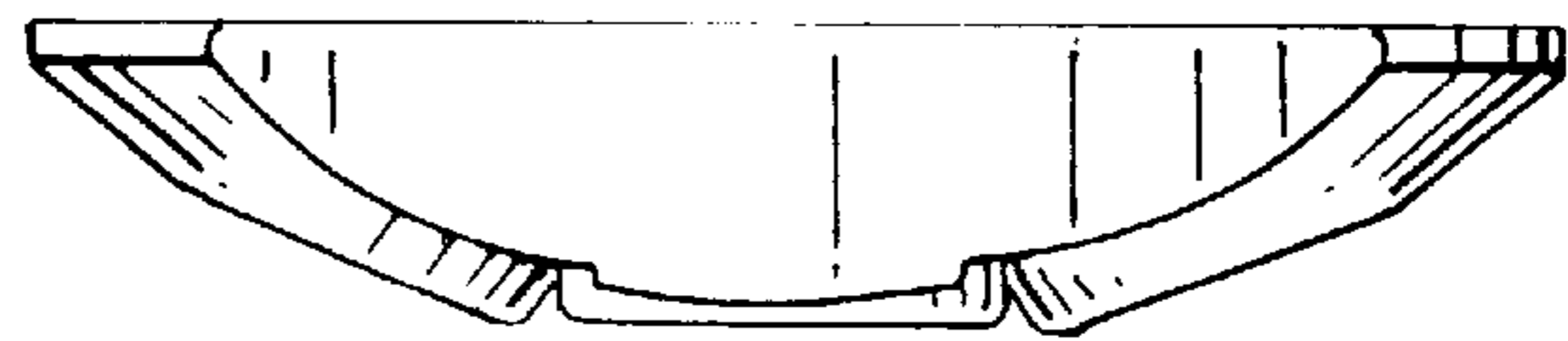

FIG. 3

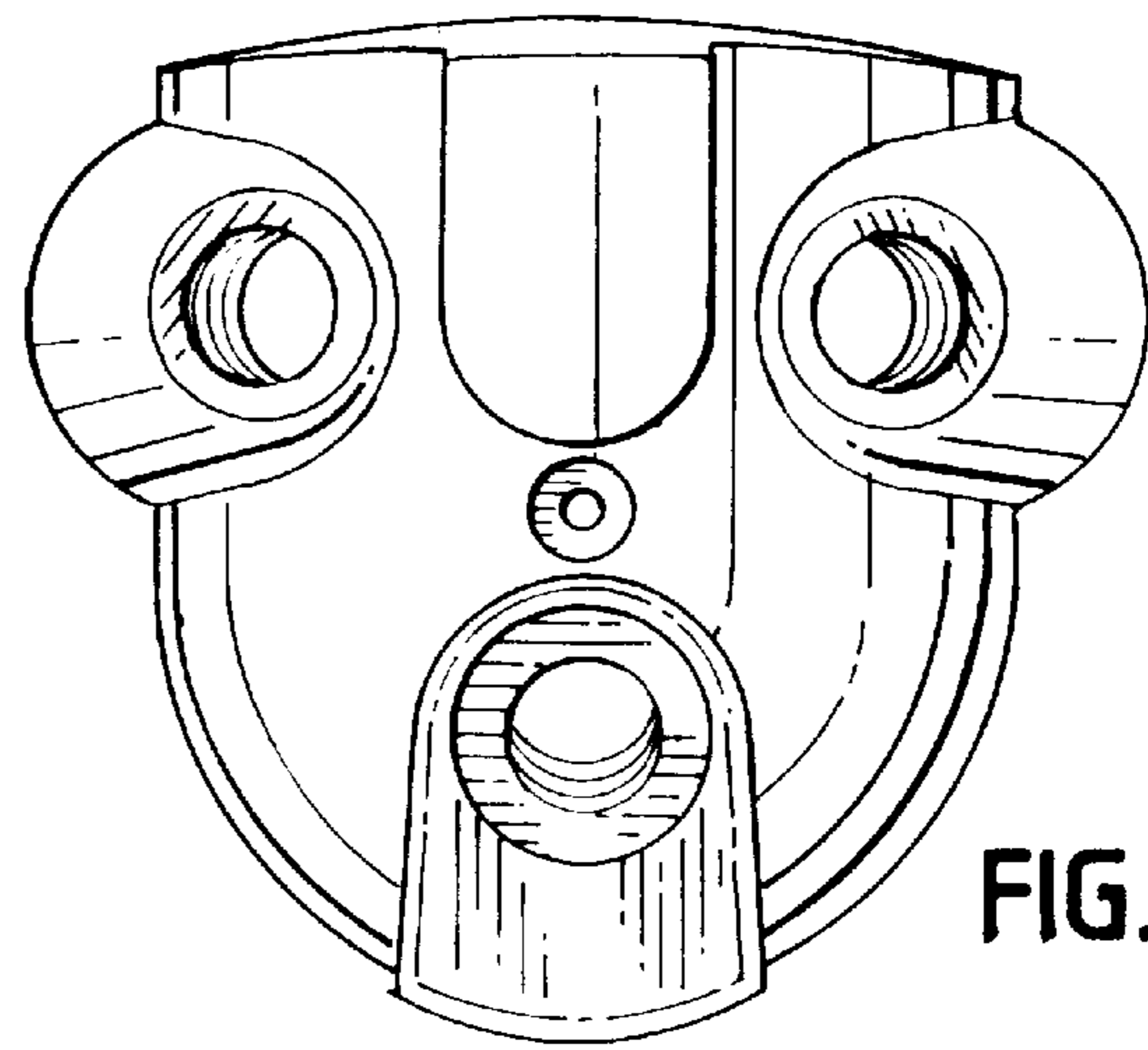
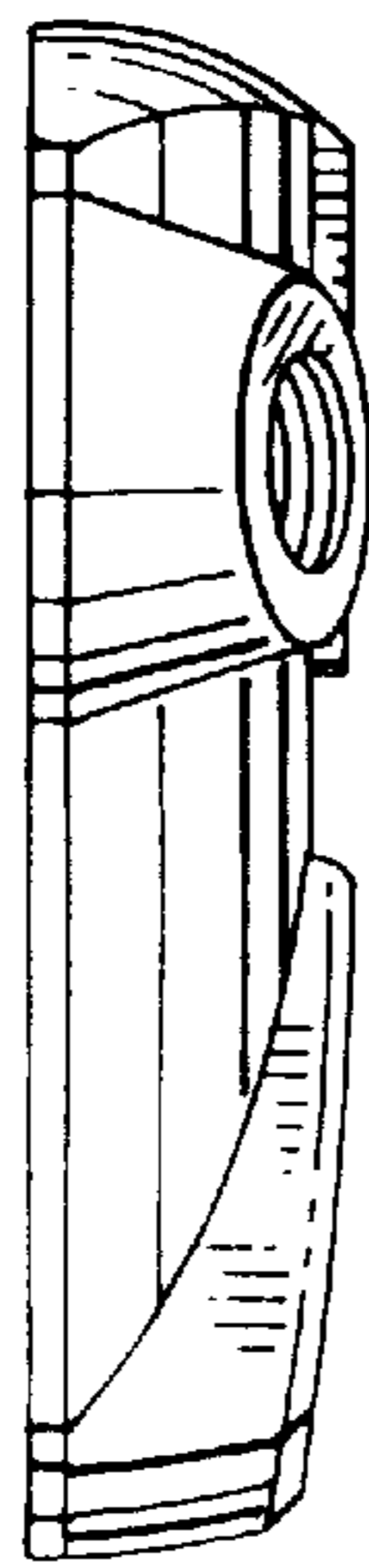

FIG. 4

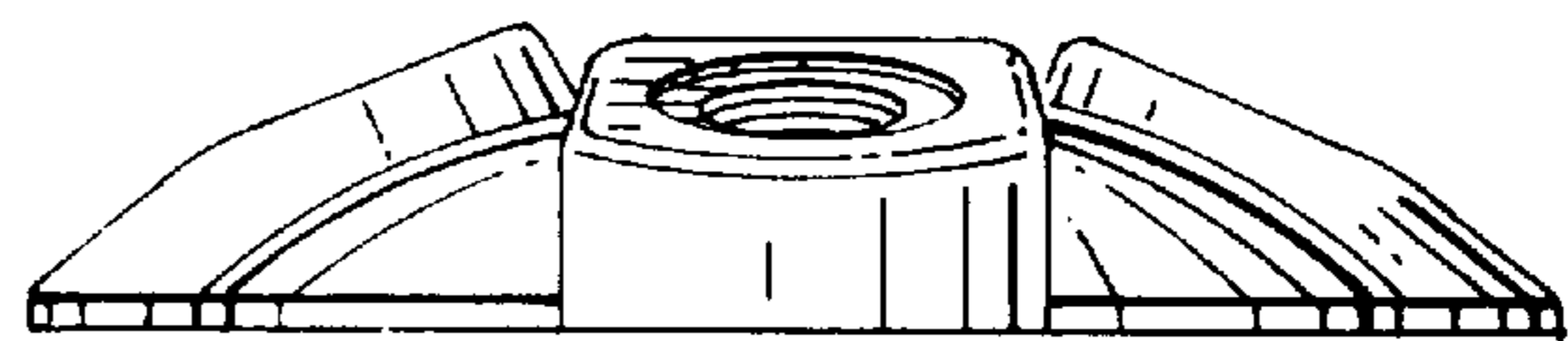

FIG. 5