



US00D431305S

United States Patent [19]

[11] Patent Number: Des. 431,305

Barth et al.

[45] Date of Patent: ** Sep. 26, 2000

[54] PAVING STONE

[75] Inventors: **Gunter Barth**, Buhlertal; **Michael Schmitz**, Buhl, both of Germany

[73] Assignee: **F. Von Langsdorff Licensing Ltd.**, Inglewood, Canada

[**] Term: **14 Years**

[21] Appl. No.: **29/078,215**

[22] Filed: **Oct. 21, 1997**

[30] Foreign Application Priority Data

Apr. 23, 1997 [XH] Hague Agreement DM/039945
May 15, 1997 [XH] Hague Agreement DM/040156

[51] **LOC (7) Cl.** **25-01**

[52] **U.S. Cl.** **D25/113**

[58] **Field of Search** D25/113-118;
52/596, 604-605; 404/34, 37-42; D21/484,
489, 491, 500

[56] References Cited

U.S. PATENT DOCUMENTS

150,710 5/1874 Prindle .

(List continued on next page.)

FOREIGN PATENT DOCUMENTS

89 00 276 12/1989 Germany .
44 05 616 11/1994 Germany .
195 20 887 1/1996 Germany .

Primary Examiner—Louis S. Zarfaz

Assistant Examiner—Robert A. Delehanty

Attorney, Agent, or Firm—Orrick, Herrington & Sutcliffe, LLP

[57] CLAIM

The ornamental design for a paving stone, as shown and described.

DESCRIPTION

FIG. 1 is a plan view of a first embodiment of the paving stone wherein the sides thereof are of approximately equal length and wherein a pair of ribs are provided on each side.

FIG. 2 is a bottom view of the embodiment of FIG. 1.

FIG. 3 is a perspective view of the embodiment of FIG. 1.

FIG. 4 is a side elevation of the embodiment of FIG. 1.

FIG. 5 is a plan view of a second embodiment of the paving stone wherein the stone is of a generally rectangular shape having two sides and two ends and wherein a pair of ribs are provided on each of the two opposite sides and a single rib is provided on each of the two opposite ends.

FIG. 6 is bottom view of the embodiment of FIG. 5.

FIG. 7 is a perspective view of the embodiment of FIG. 5.

FIG. 8 is a side elevation of the embodiment of FIG. 5.

FIG. 9 is an end elevation of the embodiment of FIG. 5.

FIG. 10 is a plan view of a third embodiment wherein the paving stone is of a generally rectangular shape and wherein three ribs are provided on each of the two opposite sides and wherein a pair of ribs are provided on each of the two opposite ends.

FIG. 11 is a bottom view of the embodiment of FIG. 10.

FIG. 12 is a perspective view of the embodiment of FIG. 10.

FIG. 13 is a side elevation of the embodiment of FIG. 10.

FIG. 14 is an end elevation of the embodiment of FIG. 10.

FIG. 15 is a plan view of a fourth embodiment wherein the embodiment of FIG. 1 is provided with a bevel along the top edge of the paving stone.

FIG. 16 is a bottom view of the embodiment of FIG. 15.

FIG. 17 is a perspective view of the embodiment of FIG. 15.

FIG. 18 is a side elevation of the embodiment of FIG. 15.

FIG. 19 is a plan view of a fifth embodiment wherein the embodiment of FIG. 5 is provided with a bevel along the top edge of the paving stone.

FIG. 20 is a bottom view of the embodiment of FIG. 19.

FIG. 21 is a perspective view of the embodiment of FIG. 19.

FIG. 22 is a side elevation of the embodiment of FIG. 19.

FIG. 23 is an end elevation of the embodiment of FIG. 19.

FIG. 24 is a plan view of a sixth embodiment wherein the embodiment of FIG. 10 is provided with a bevel along the top edge of the paving stone.

FIG. 25 is a bottom view of the embodiment of FIG. 24.

FIG. 26 is a perspective view of the embodiment of FIG. 24.

FIG. 27 is a side elevation of the embodiment of FIG. 24.

FIG. 28 is an end elevation of the embodiment of FIG. 24.

FIG. 29 is a plan view of a seventh embodiment wherein the embodiment of FIG. 22 is provided with larger ribs.

FIG. 30 is a bottom view of the embodiment of FIG. 29.

FIG. 31 is a perspective view of the embodiment of FIG. 29.

FIG. 32 is a side elevation of the embodiment of FIG. 29; and,

FIG. 33 is an end elevation of the embodiment of FIG. 29.

1 Claim, 9 Drawing Sheets

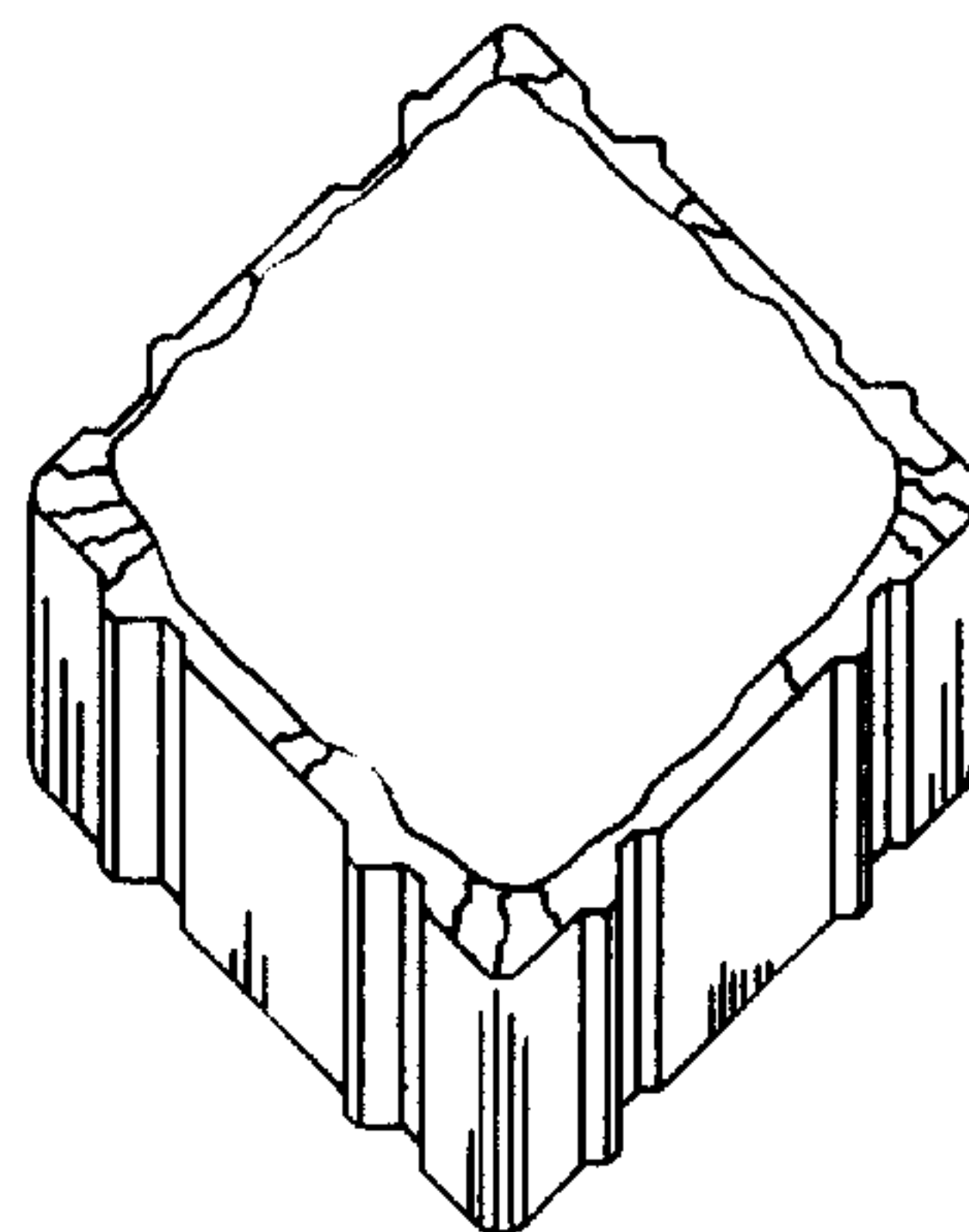
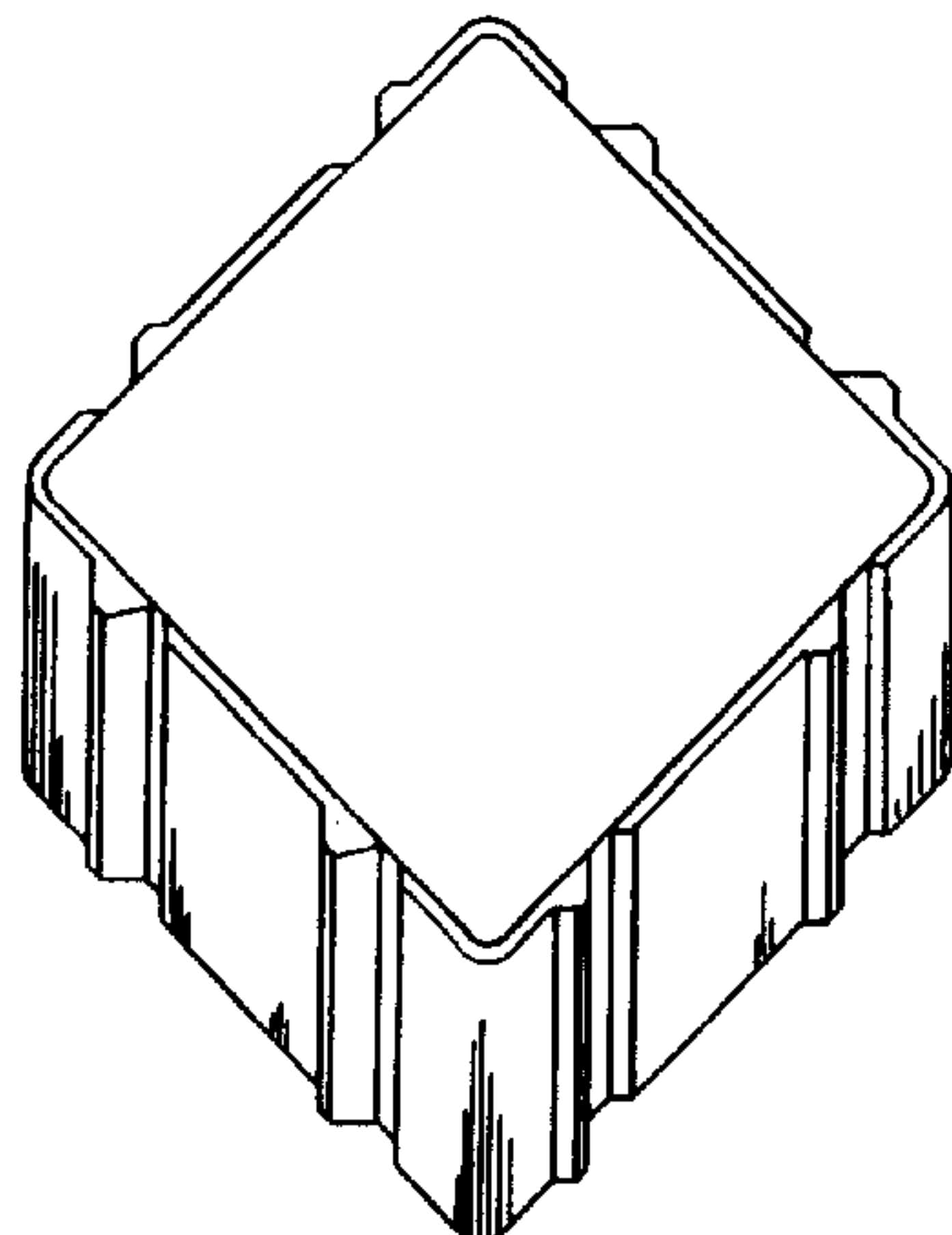

Des. 431,305

Page 2

U.S. PATENT DOCUMENTS					
			4,185,939	1/1980	Barth et al. .
			4,583,341	4/1986	Barth et al. .
D. 262,742	1/1982	Vesterholt	4,627,764	12/1986	Scheiwiller 404/41
D. 278,934	5/1985	Scheiwiller	4,761,095	8/1988	Bartlechner 404/41
D. 287,884	1/1987	Scheiwiller	4,997,308	3/1991	Welling, Jr. 404/38
D. 288,370	2/1987	Rinninger	5,051,023	9/1991	Yoshida et al. 404/39
D. 293,822	1/1988	Scheiwiller	5,224,792	7/1993	Hagenah .
D. 317,207	5/1991	Scheiwiller .	5,251,997	10/1993	Brock .
D. 317,208	5/1991	Scheiwiller .	5,348,417	9/1994	Scheiwiller 404/41
382,683	5/1888	Bignell .	5,360,285	11/1994	Barth et al. .
421,618	2/1890	Schaeffer .	5,496,129	3/1996	Dubé .
1,314,278	8/1919	McClain, Jr.	5,503,498	4/1996	Scheiwiller .
1,422,193	7/1922	Sullivan et al.	5,622,456	4/1997	Risi et al. 405/284
3,557,669	1/1971	Fenton .	5,902,069	5/1999	Barth et al. 404/34
4,016,692	4/1977	Jordan et al. .			
4,067,196	1/1978	Schraudenbach .			

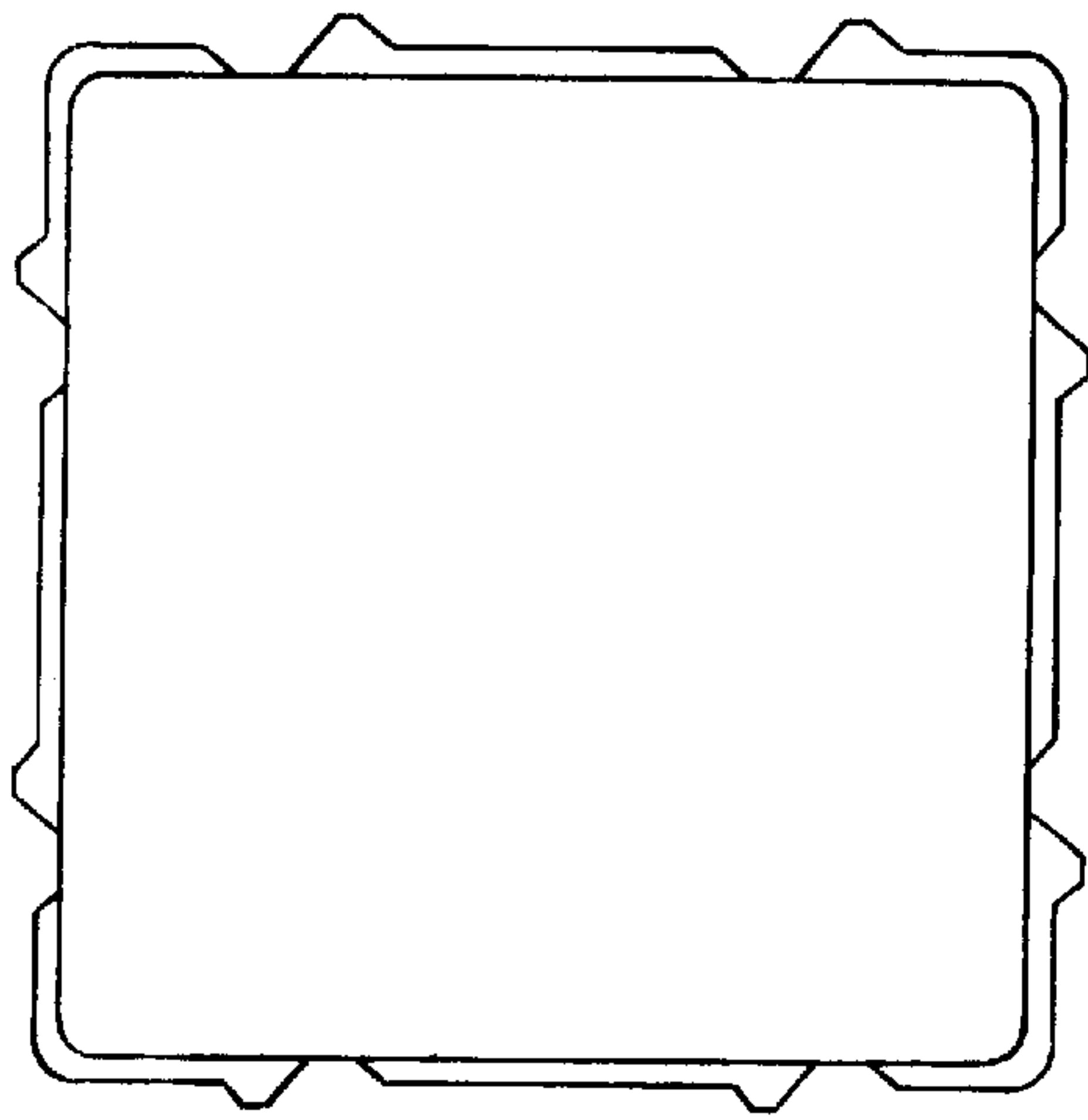

FIG. 1

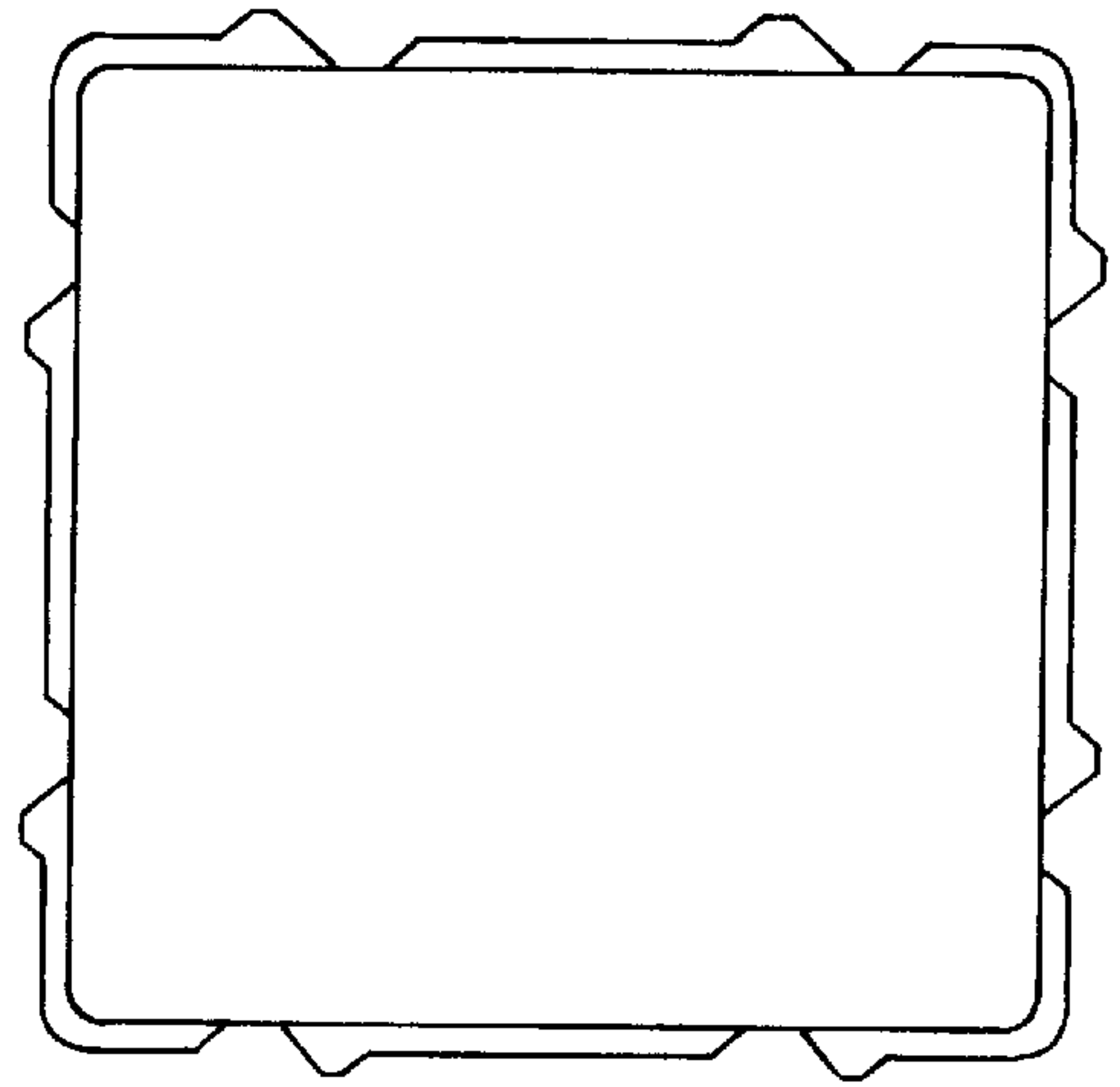

FIG. 2

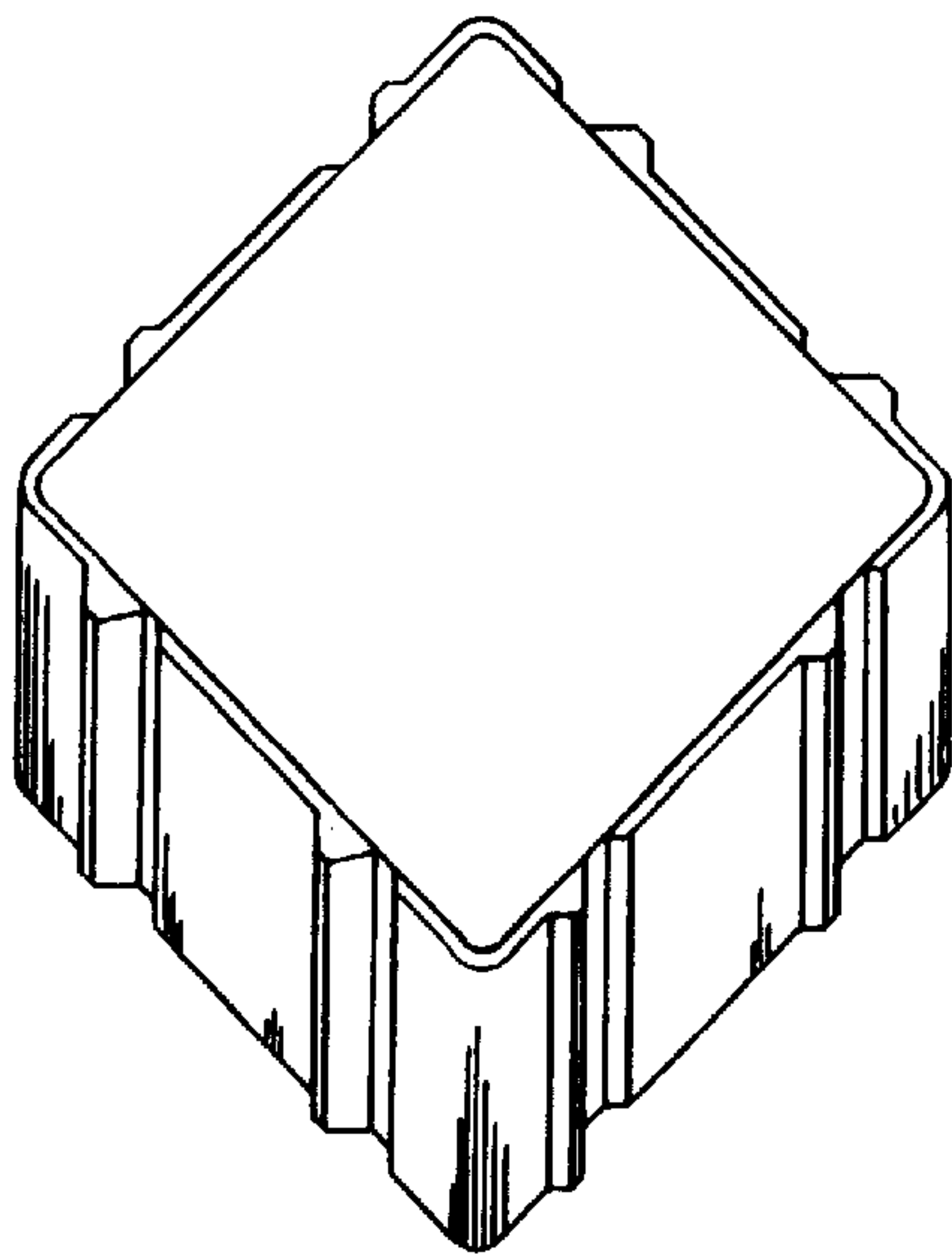

FIG. 3

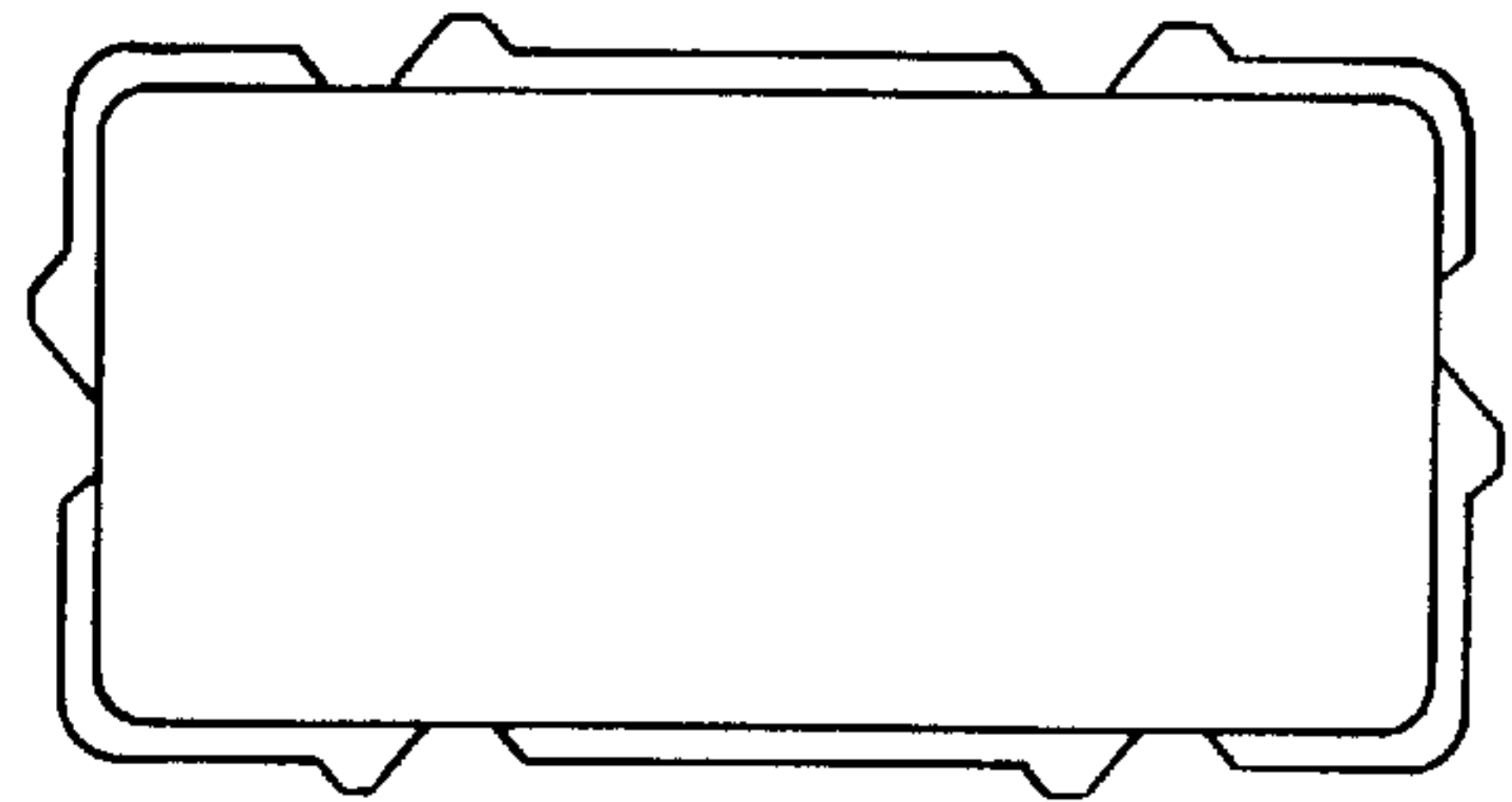

FIG. 5

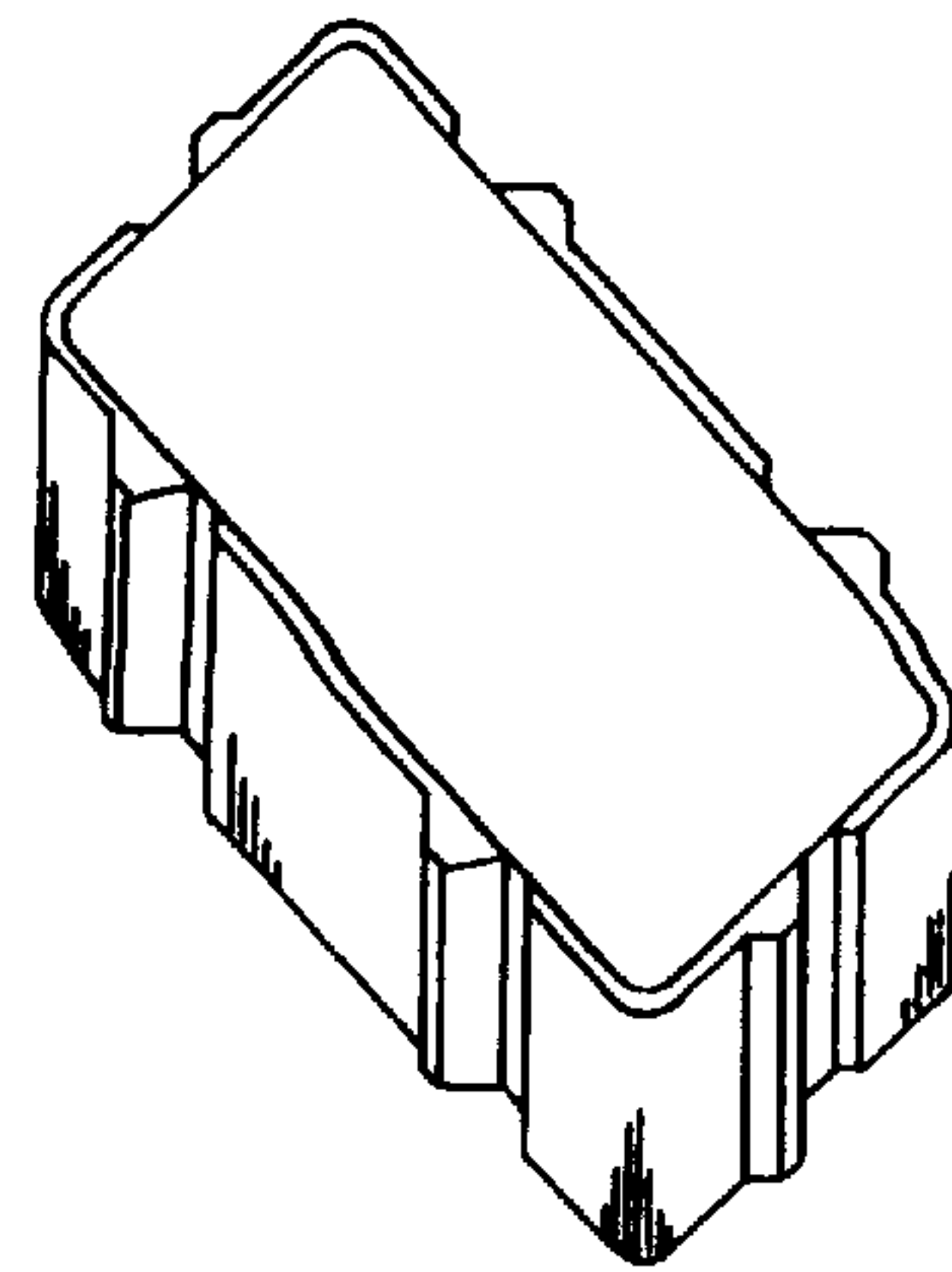

FIG. 7



FIG. 4

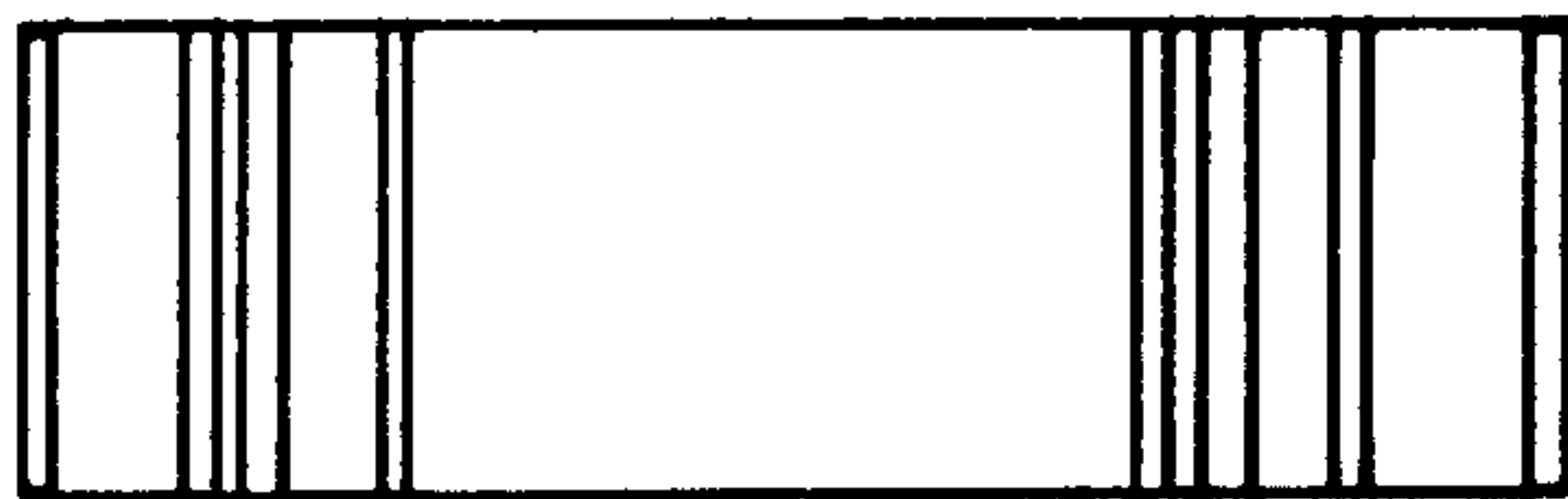

FIG. 8

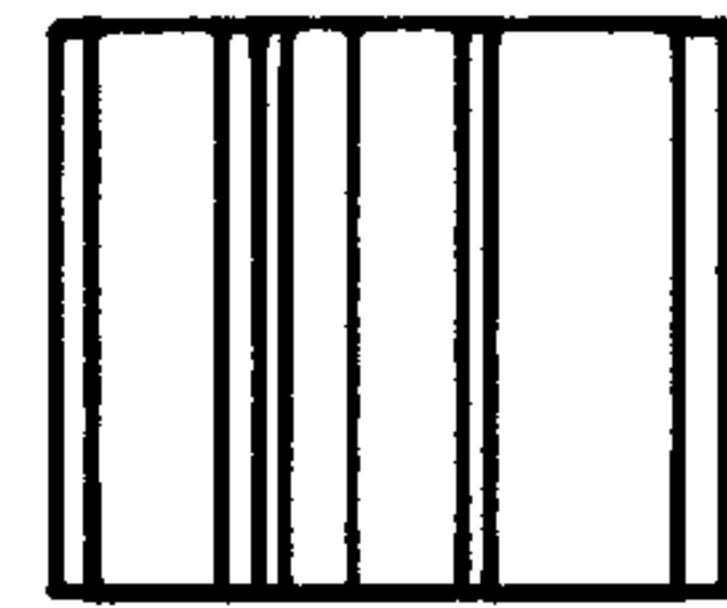

FIG. 9

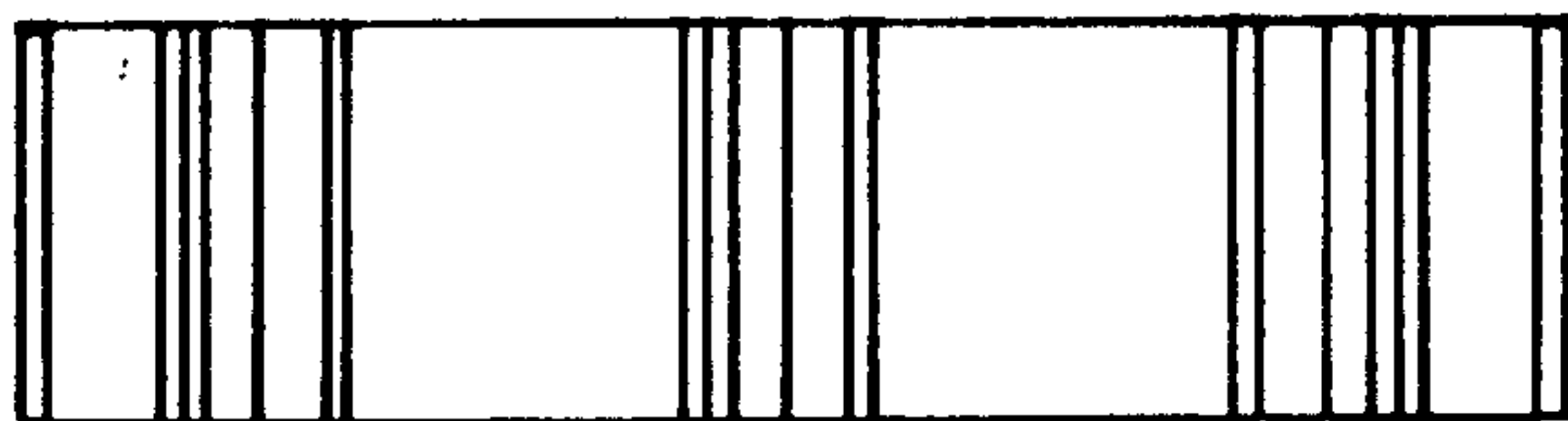

FIG. 13

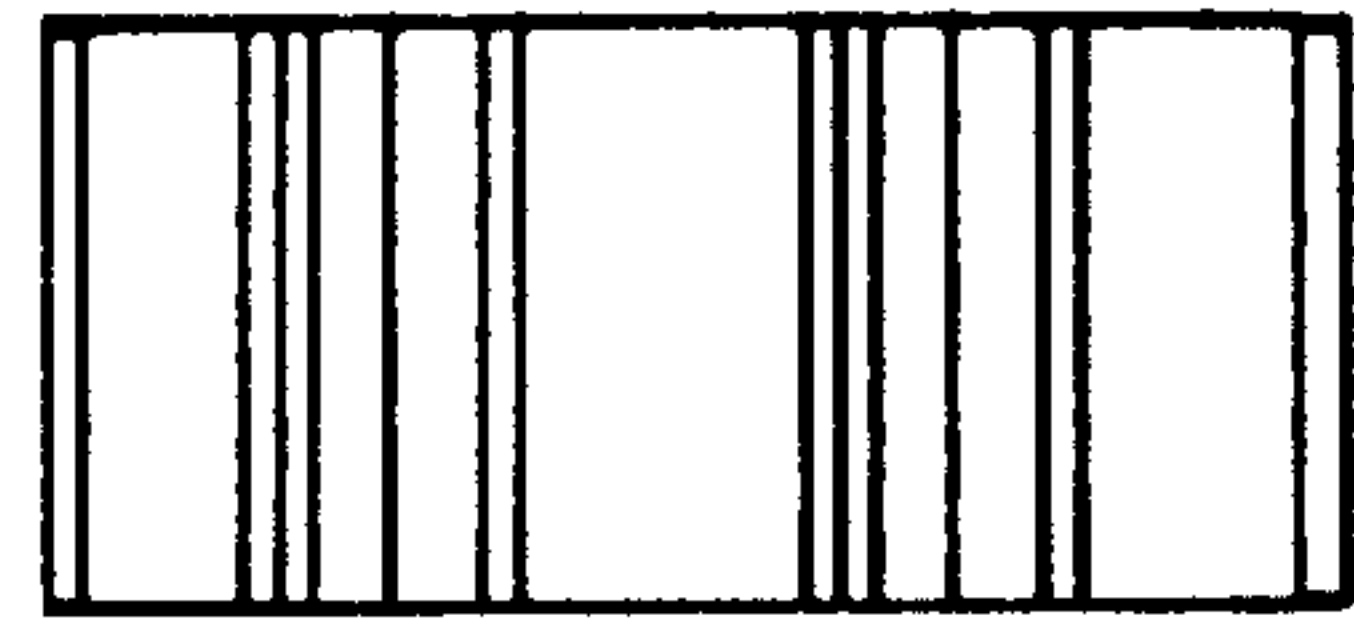

FIG. 14

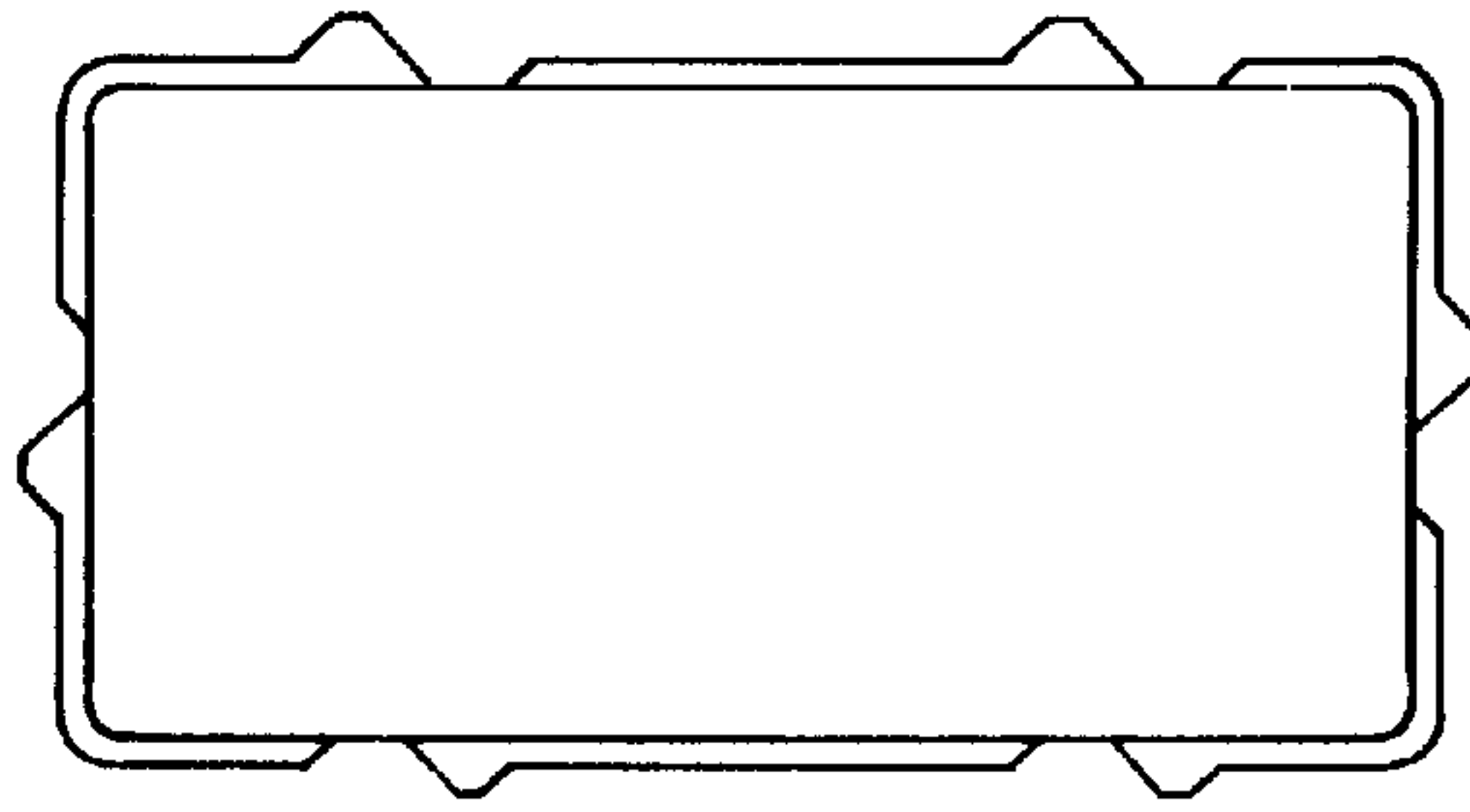

FIG. 6

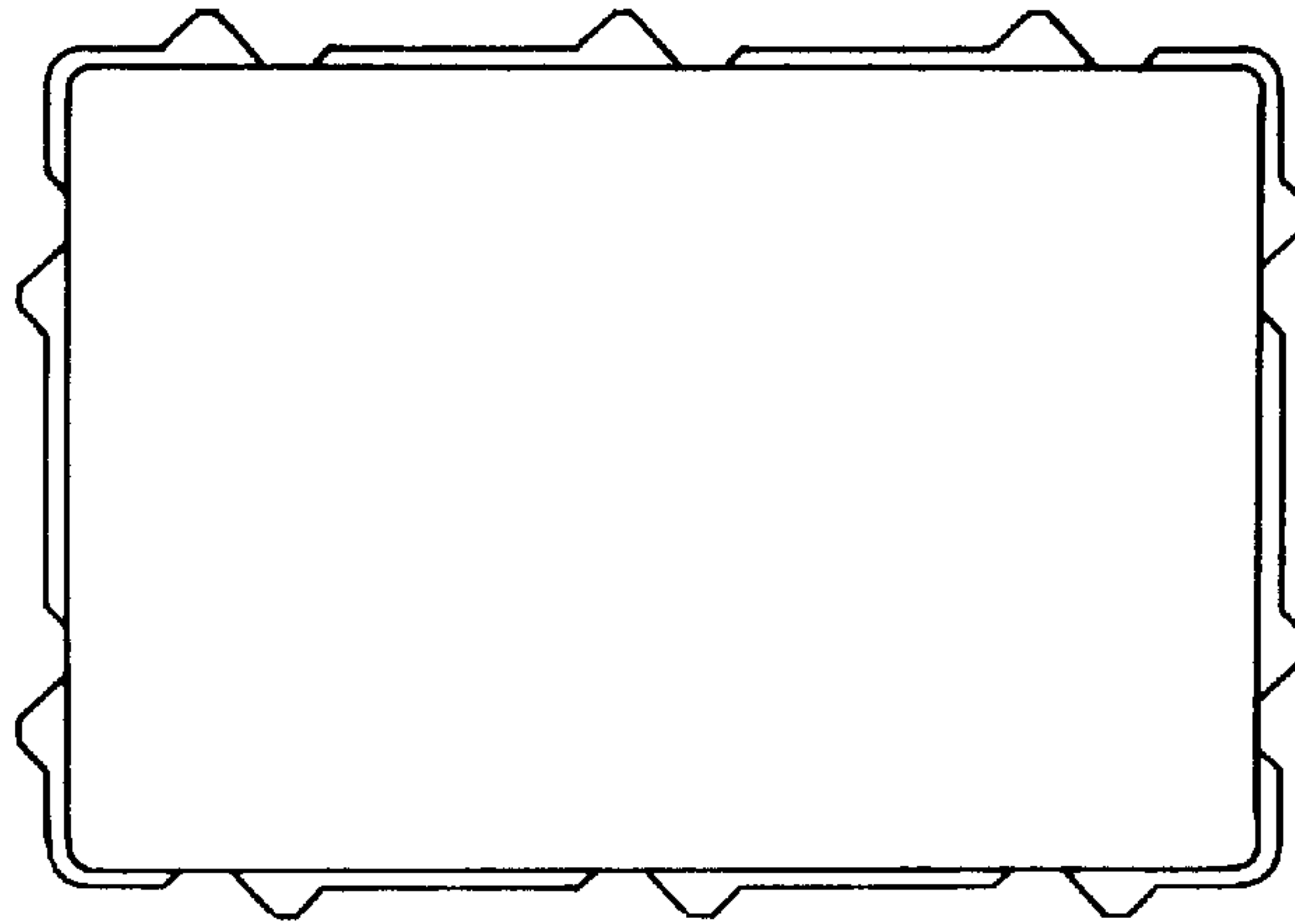

FIG. 11

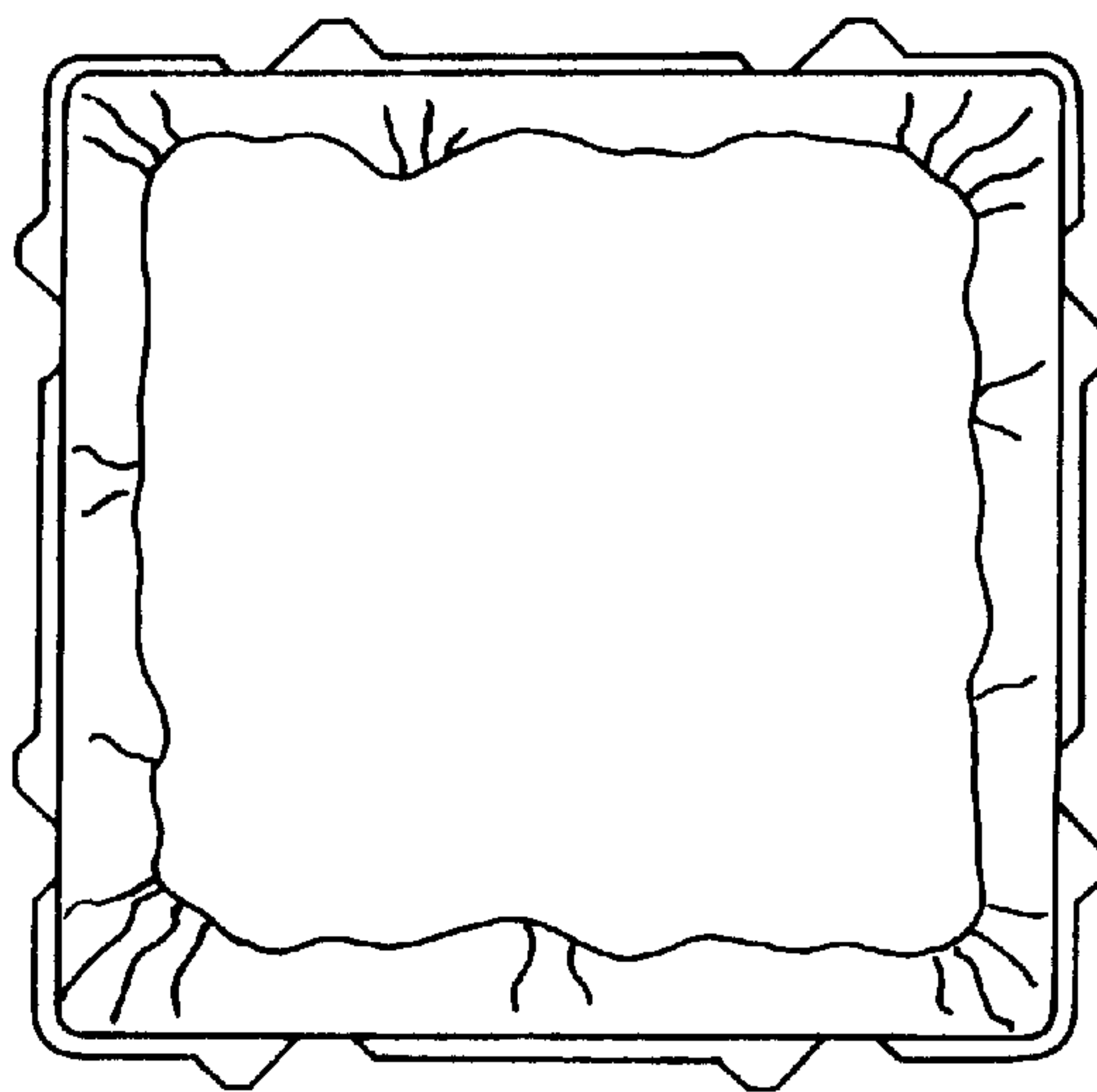

FIG. 15

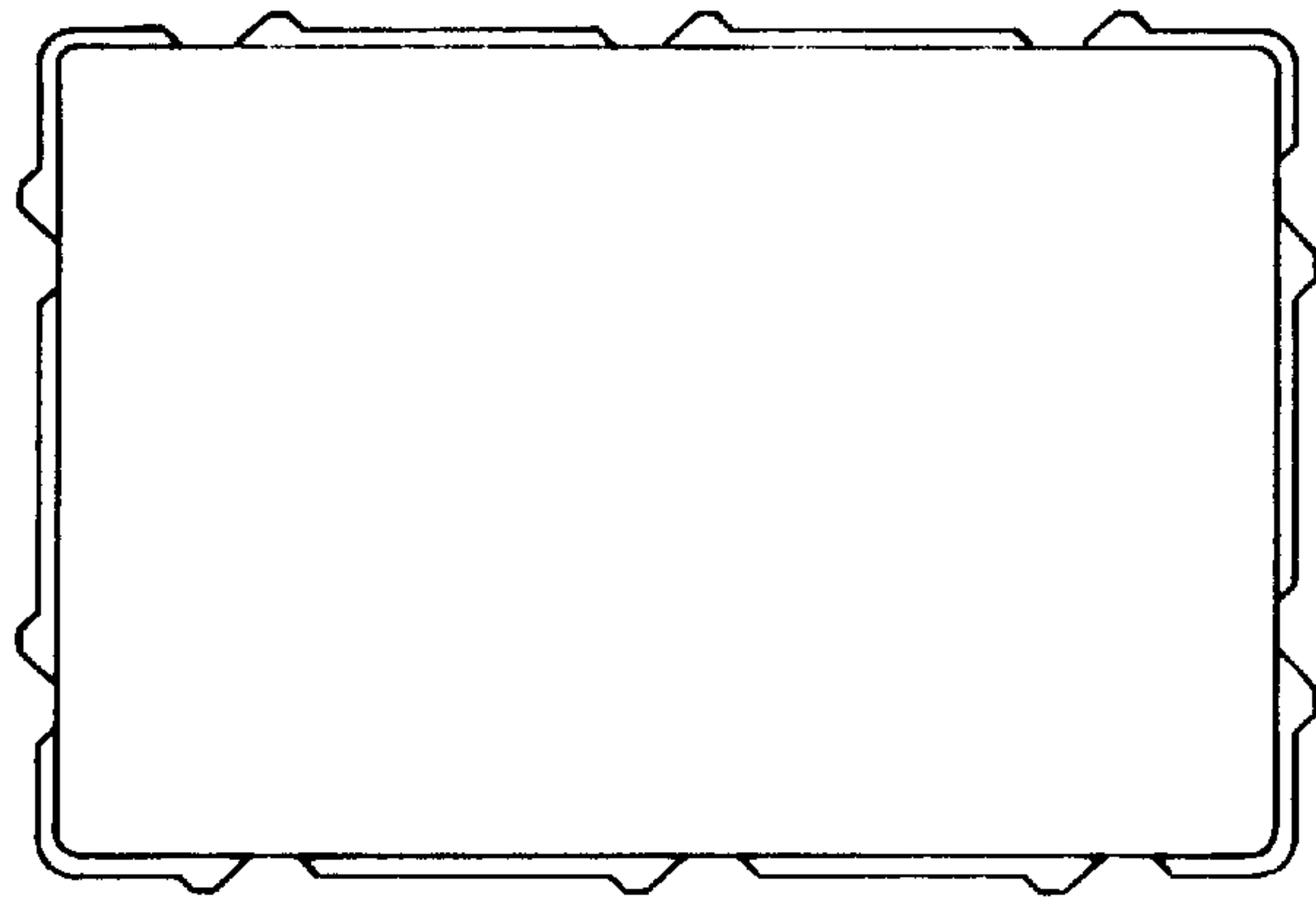

FIG. 10

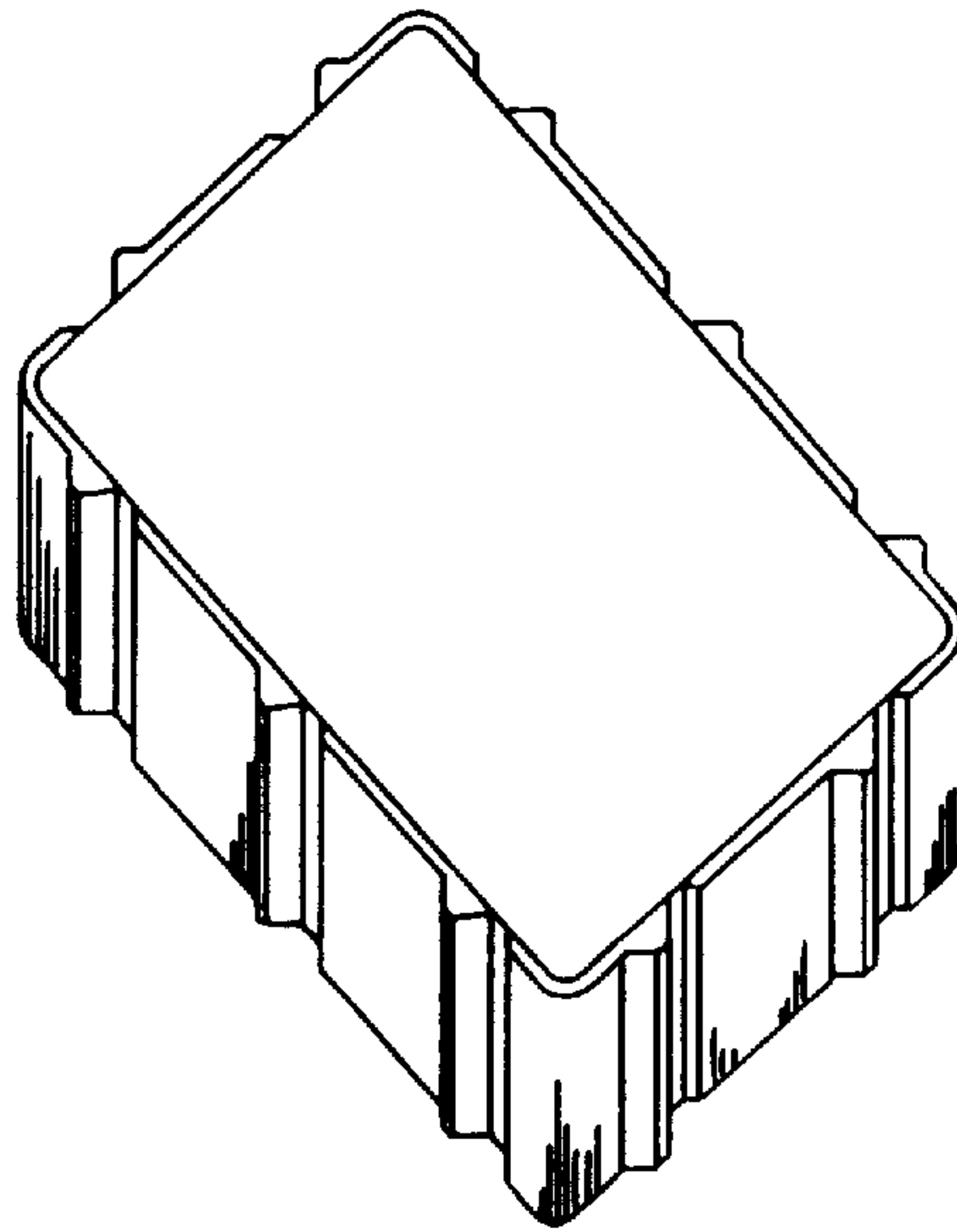

FIG. 12

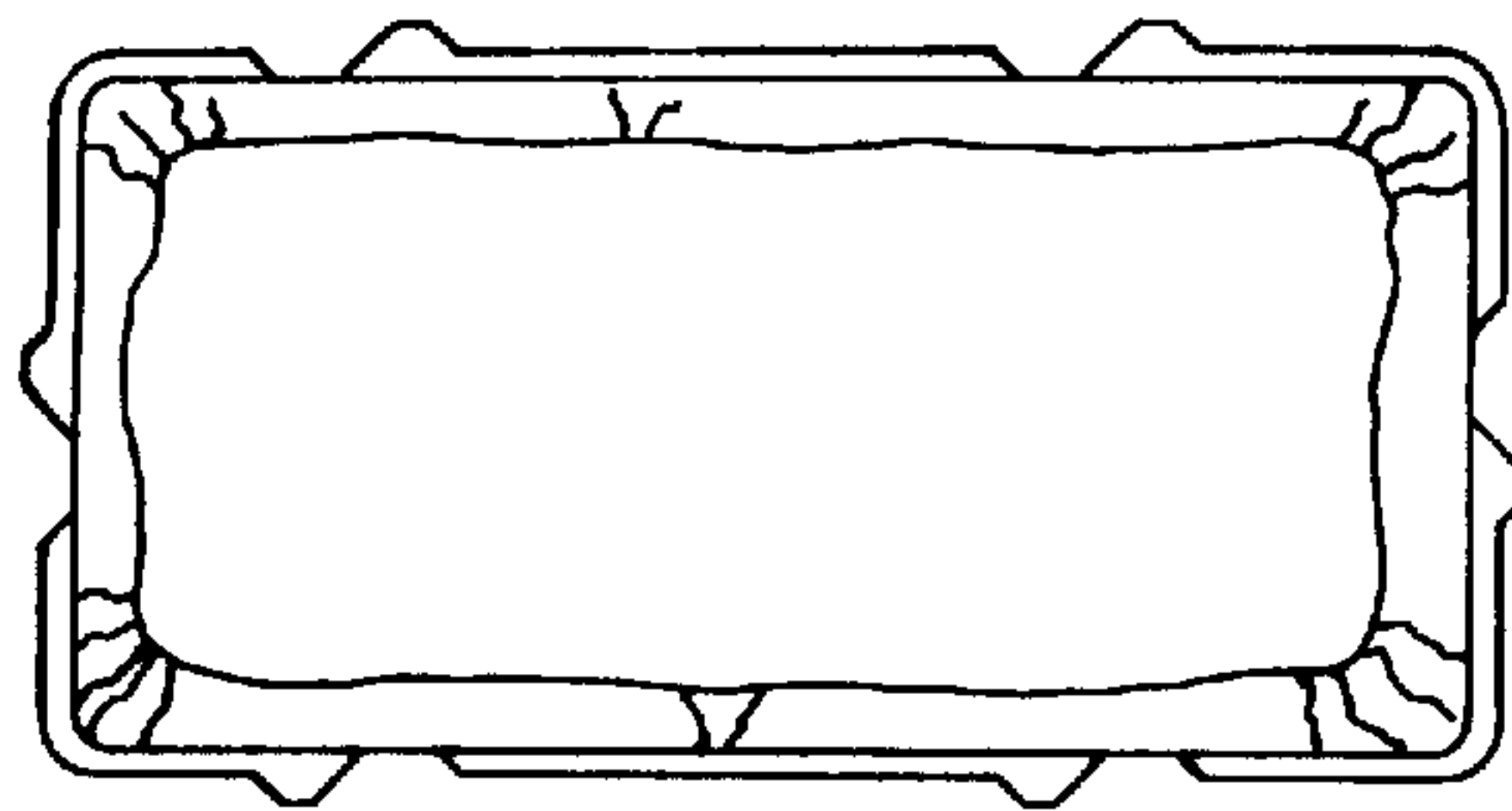

FIG. 19

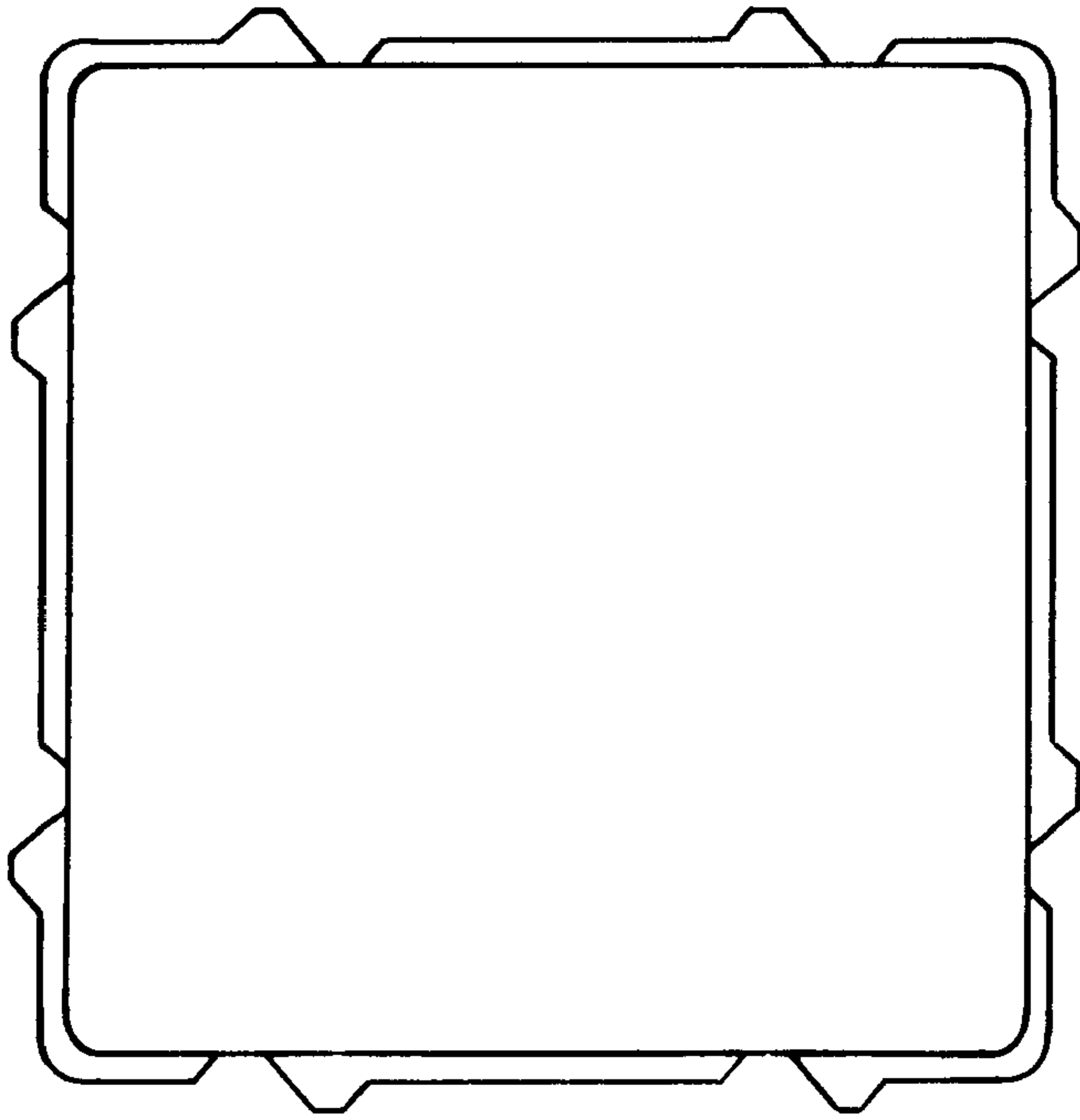

FIG. 16

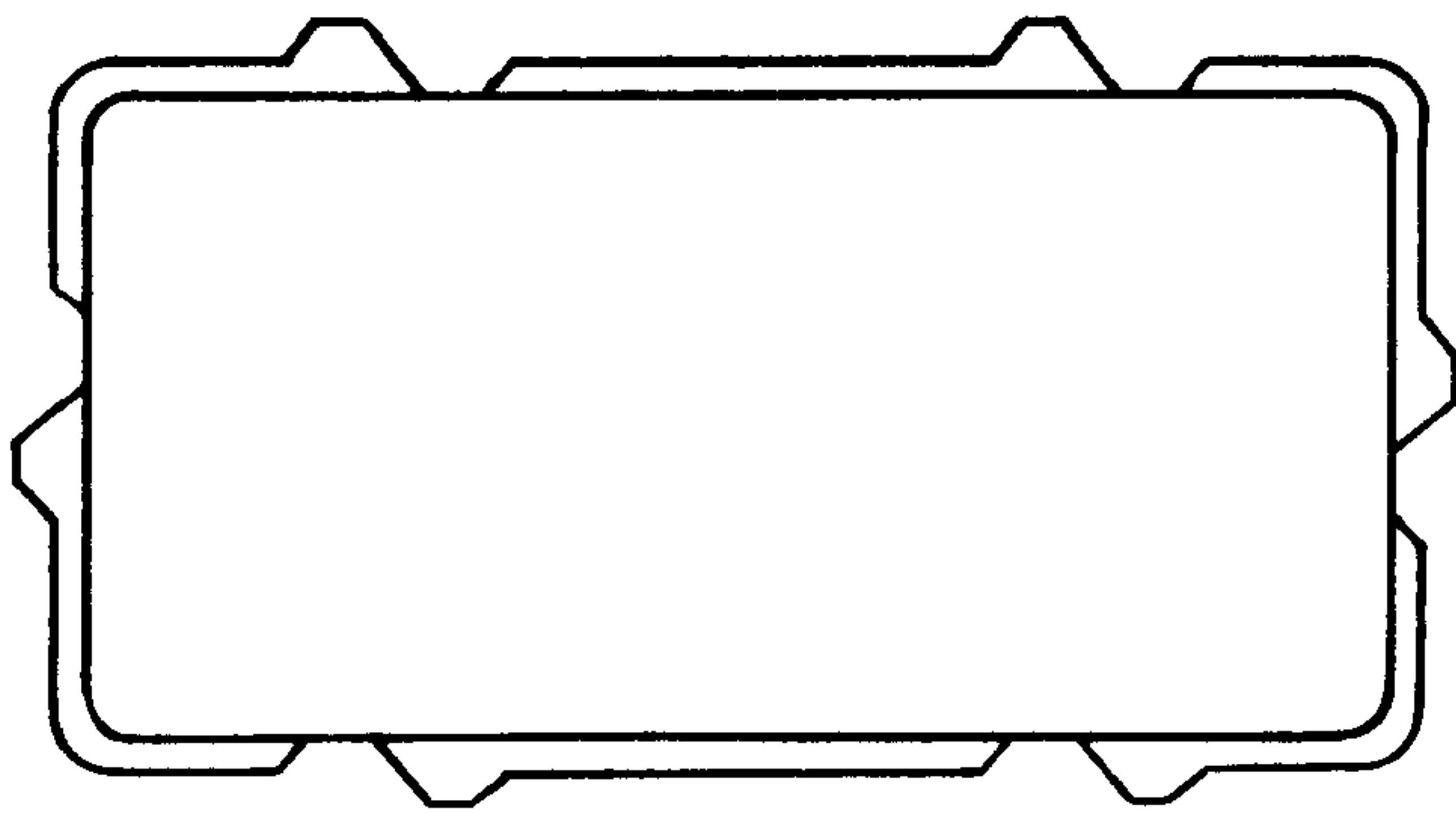

FIG. 20

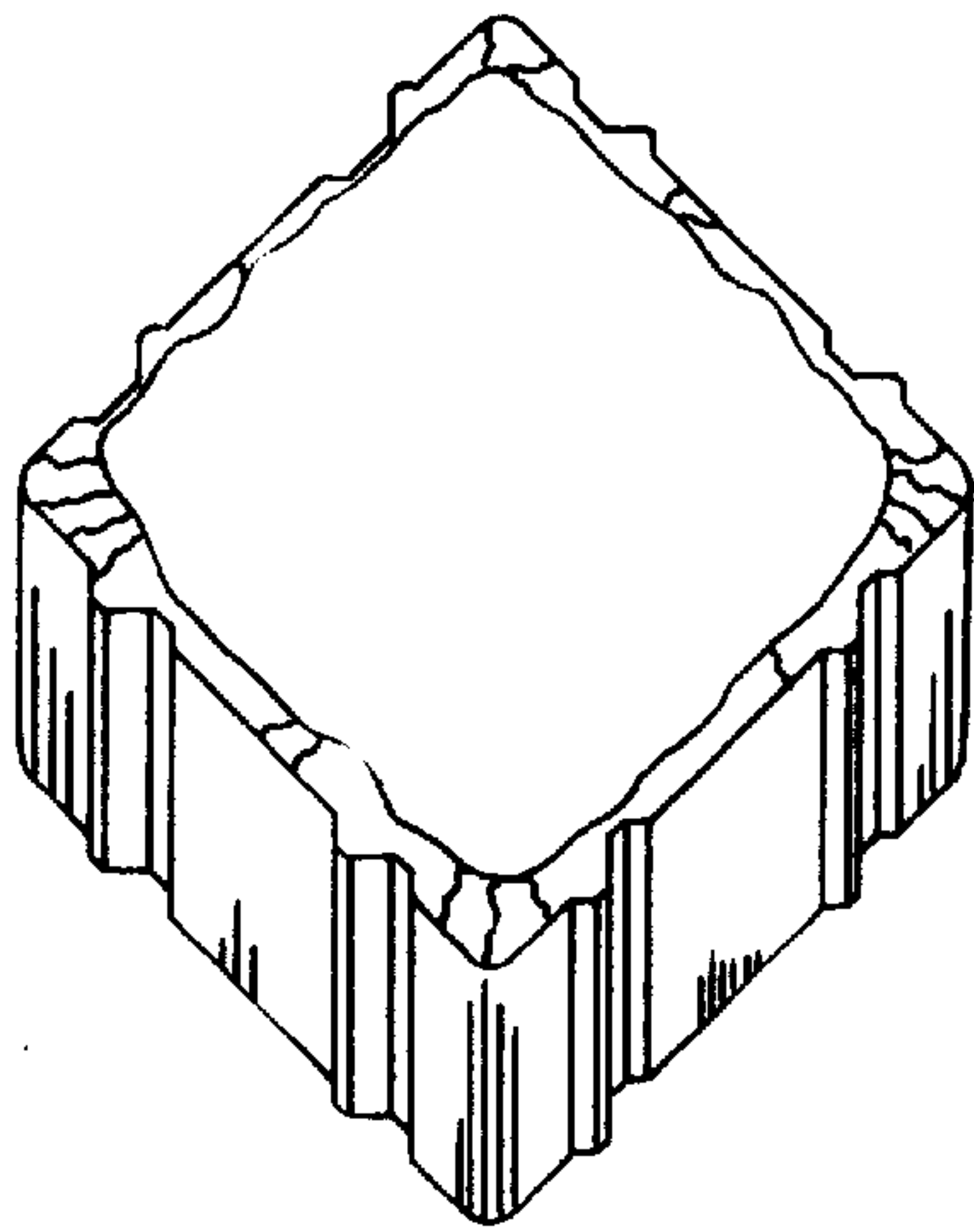

FIG. 17

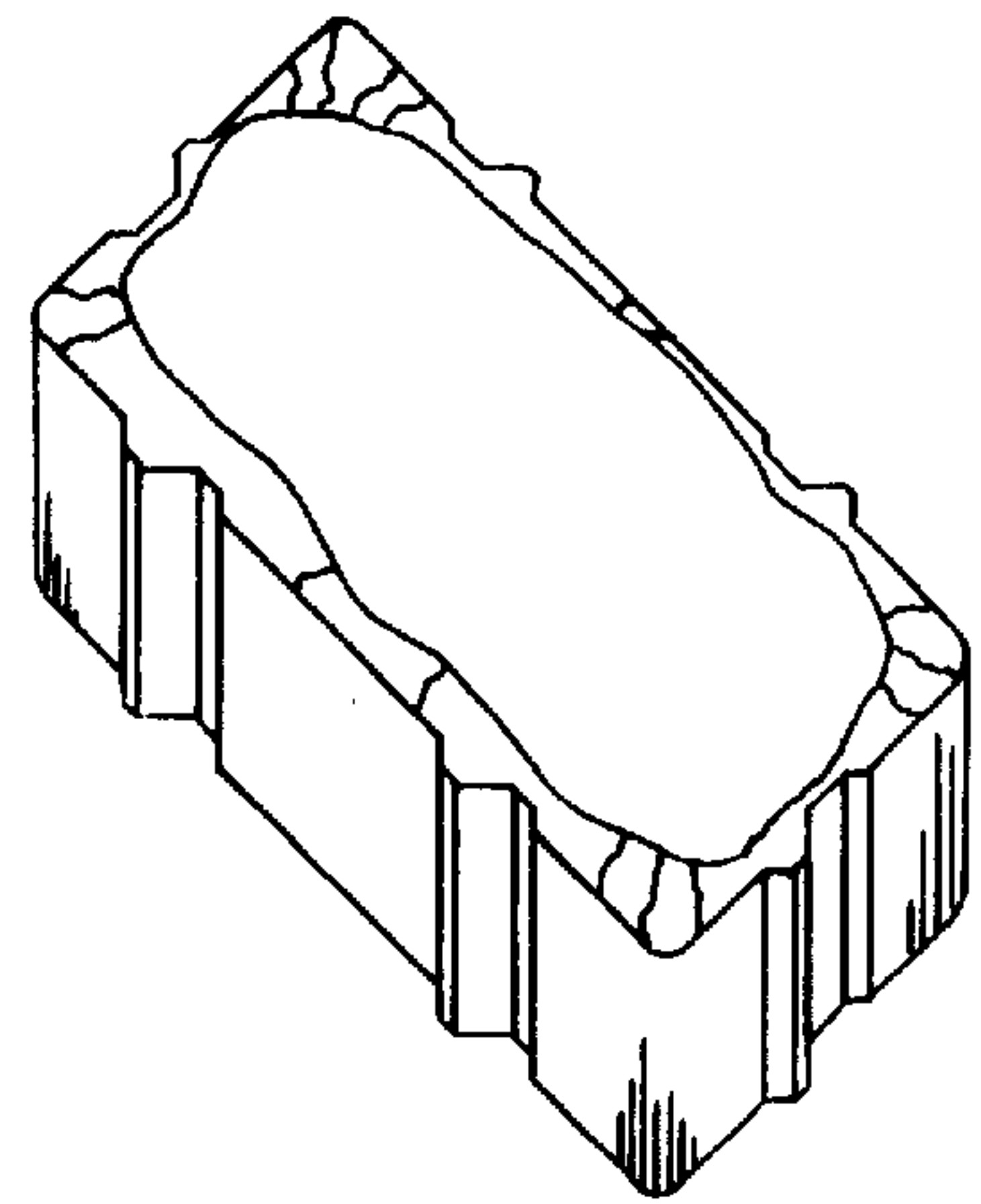

FIG. 21

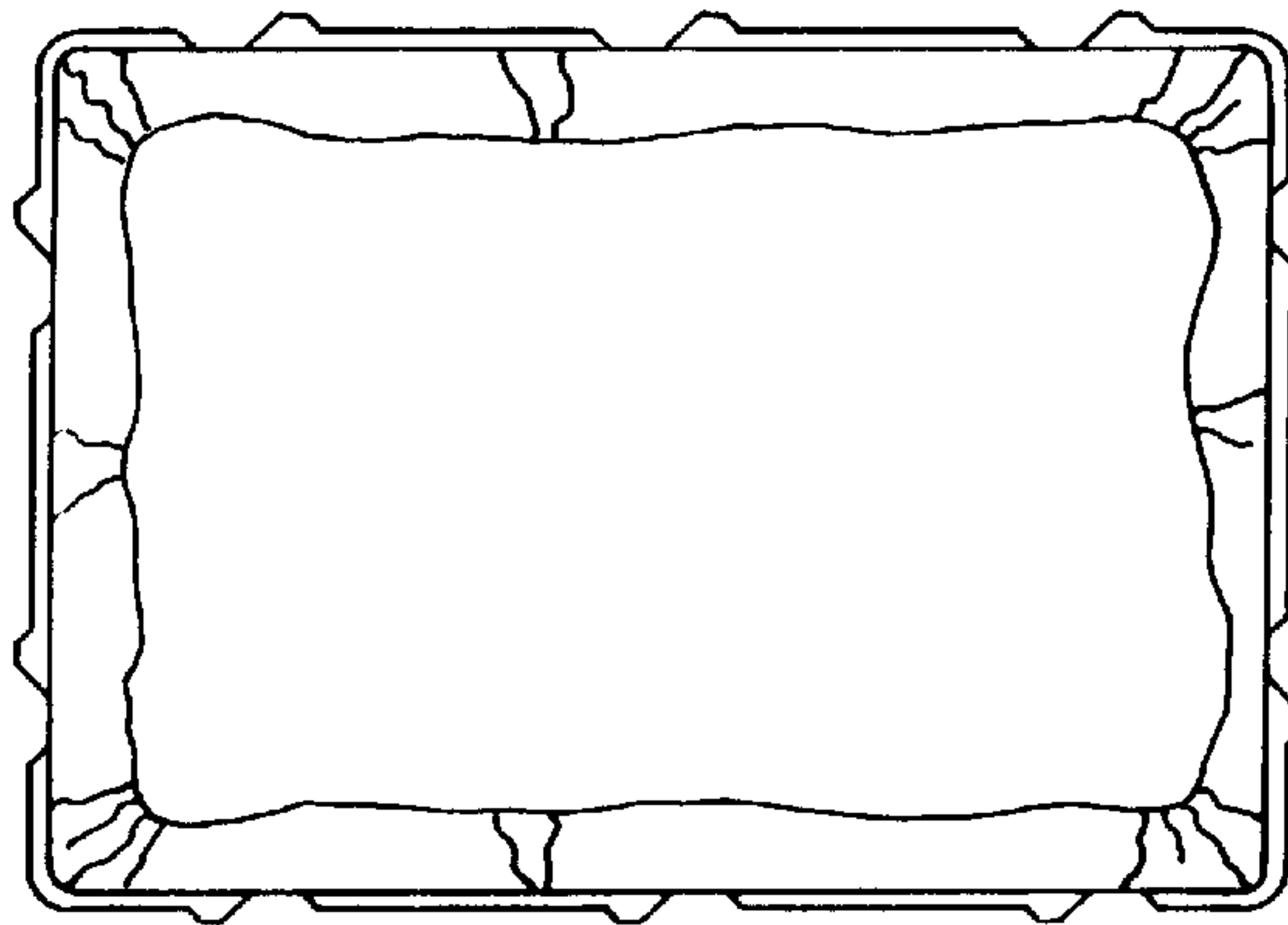

FIG. 24

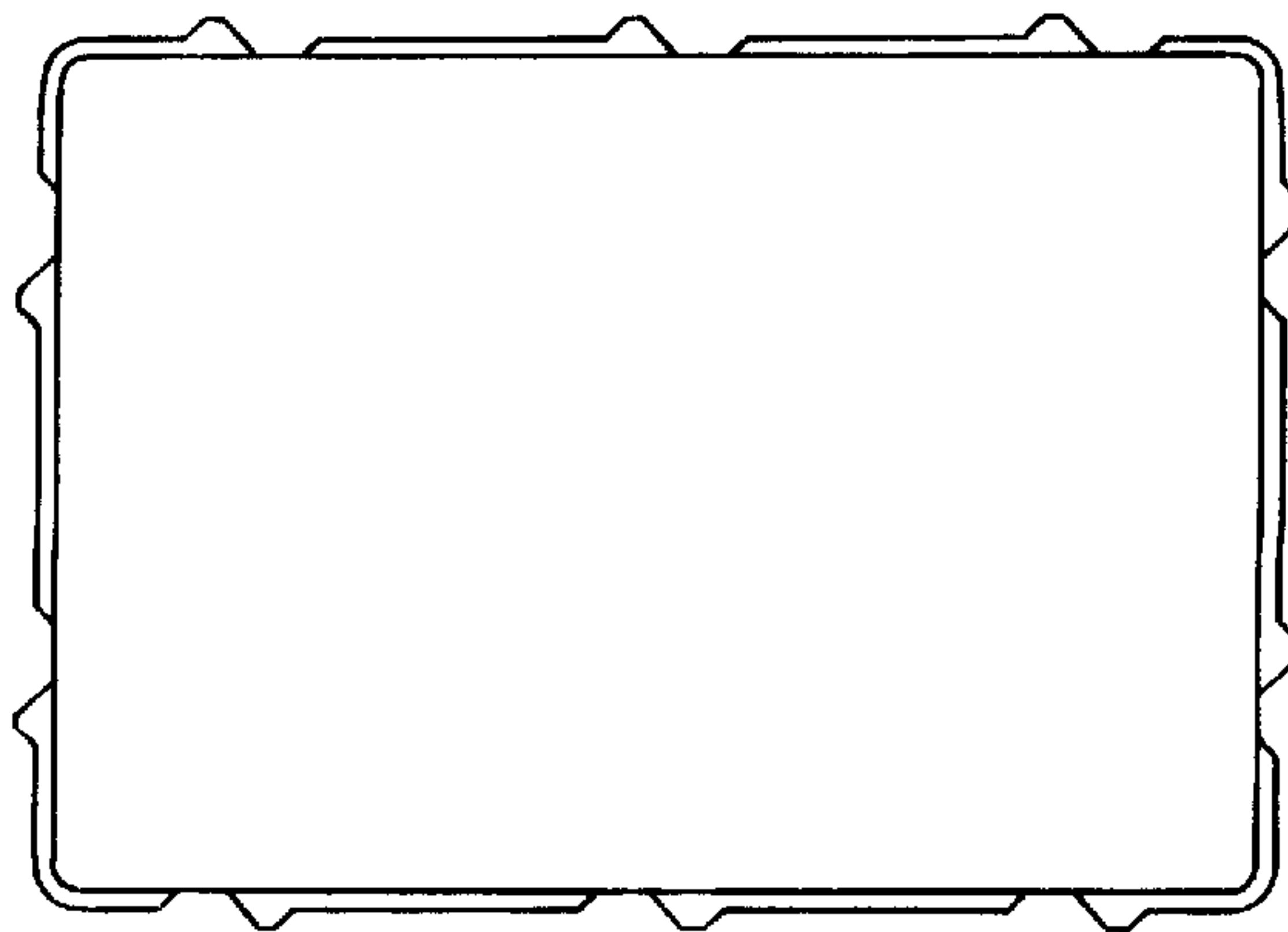

FIG. 25

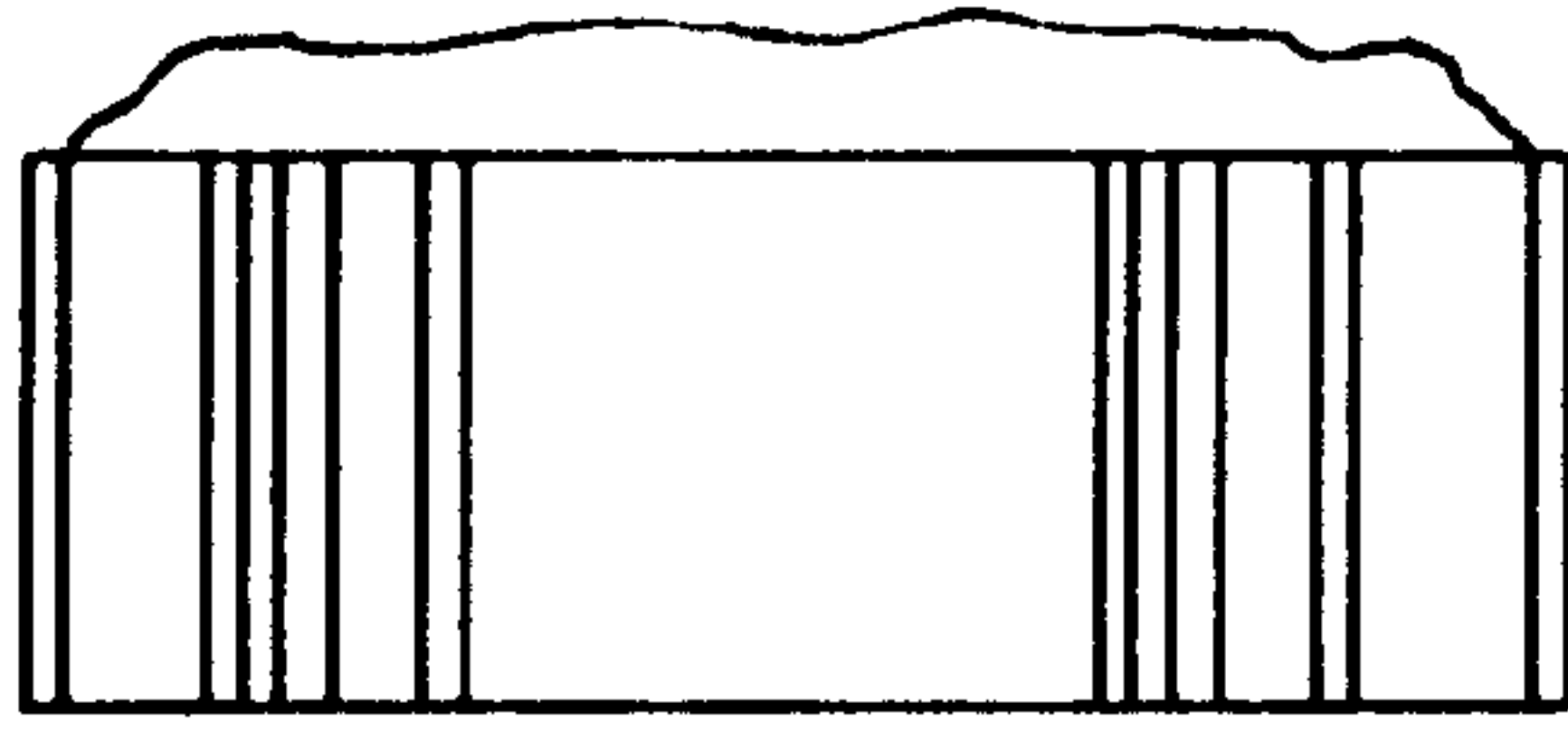

FIG. 18

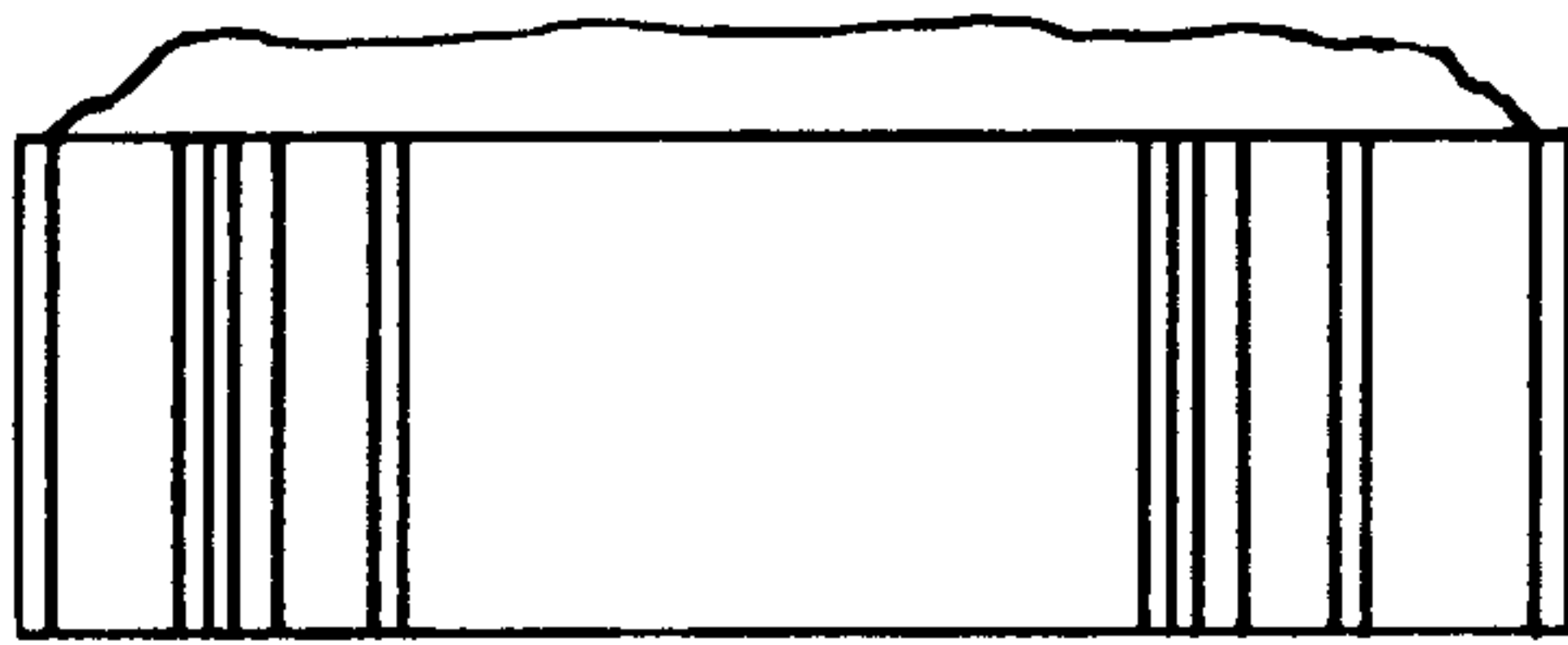

FIG. 22

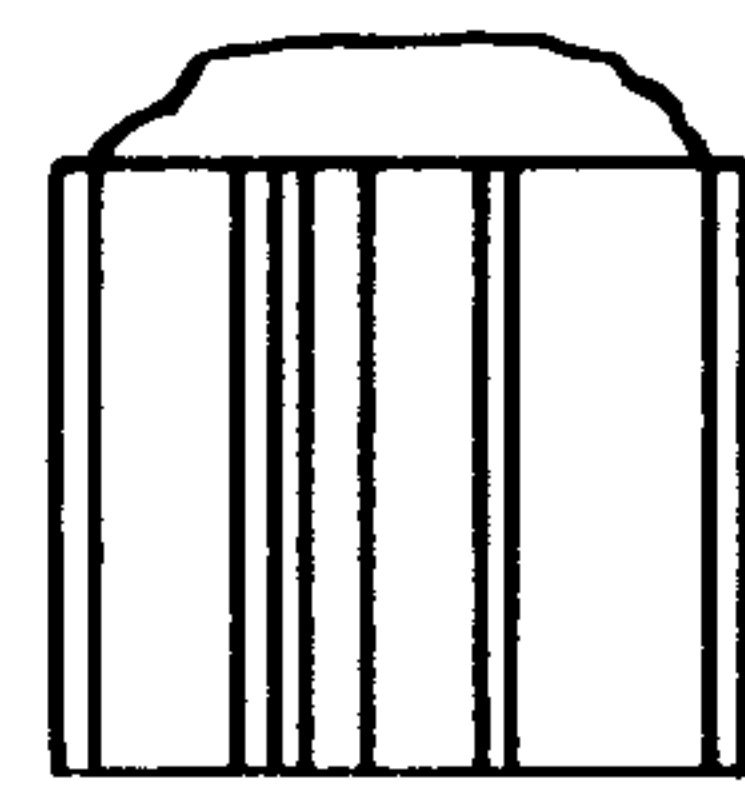

FIG. 23

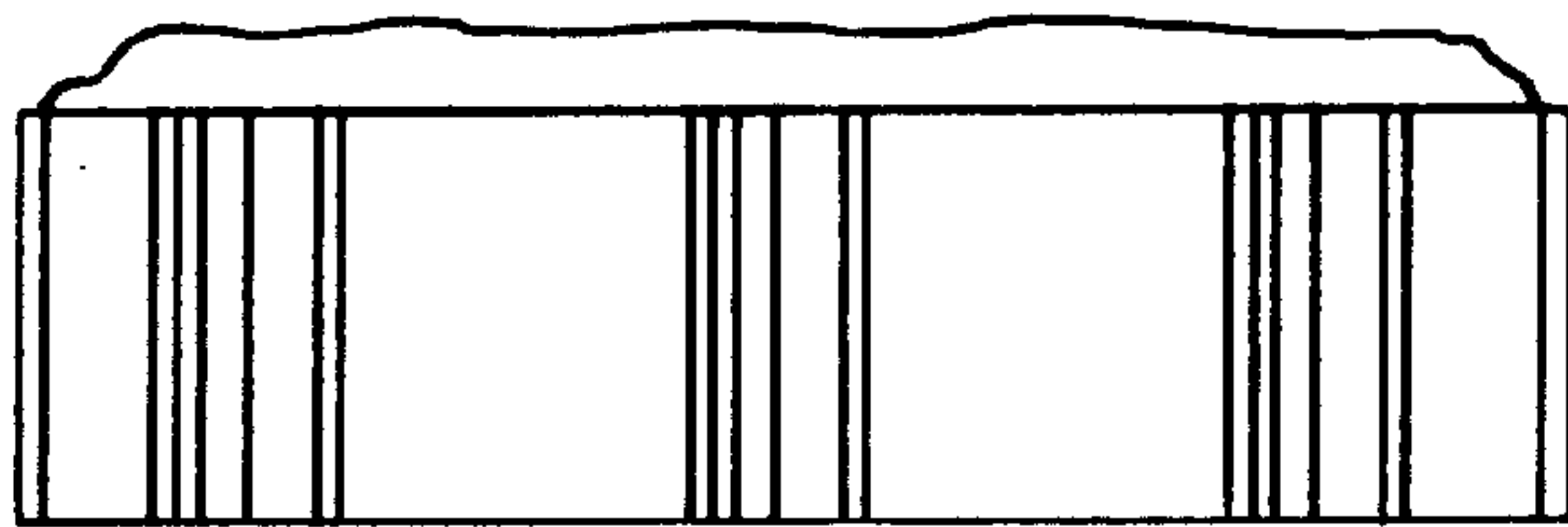

FIG. 27

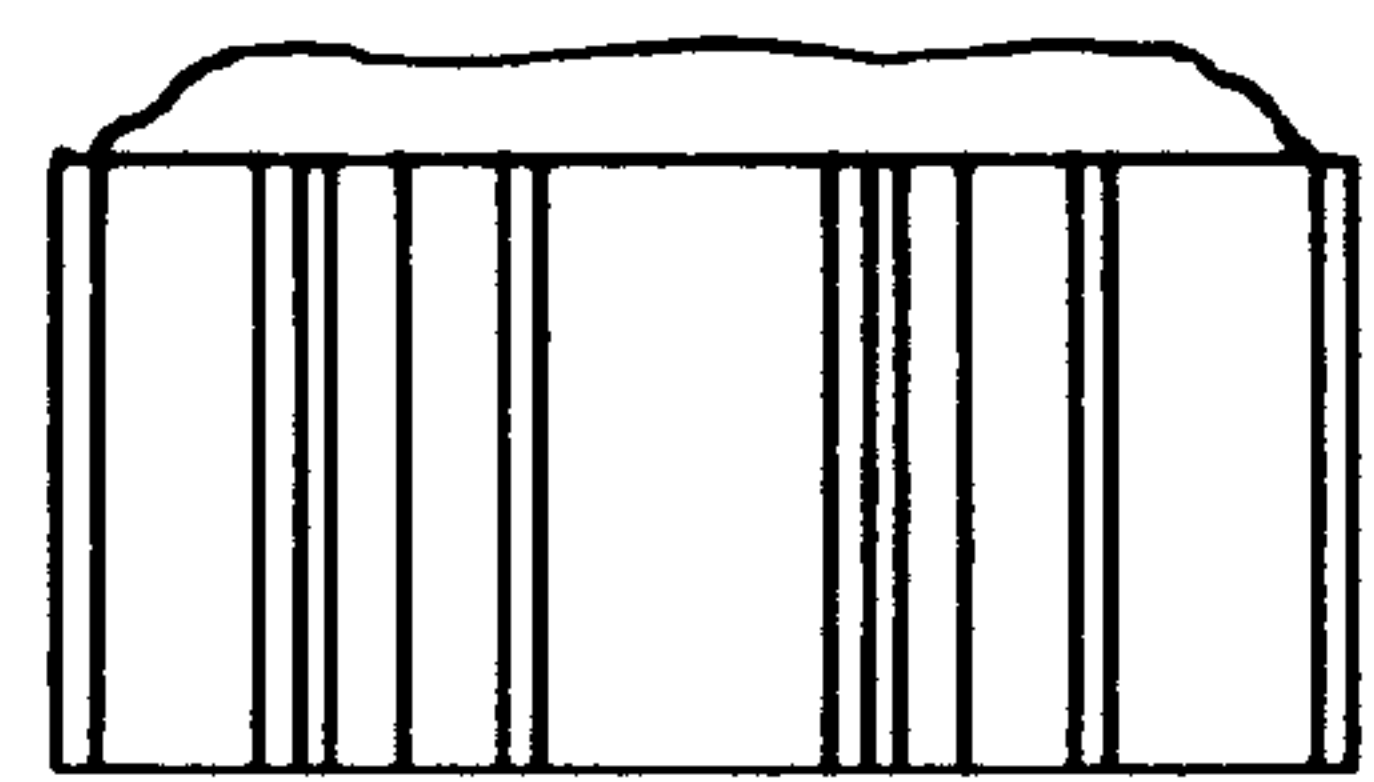

FIG. 28

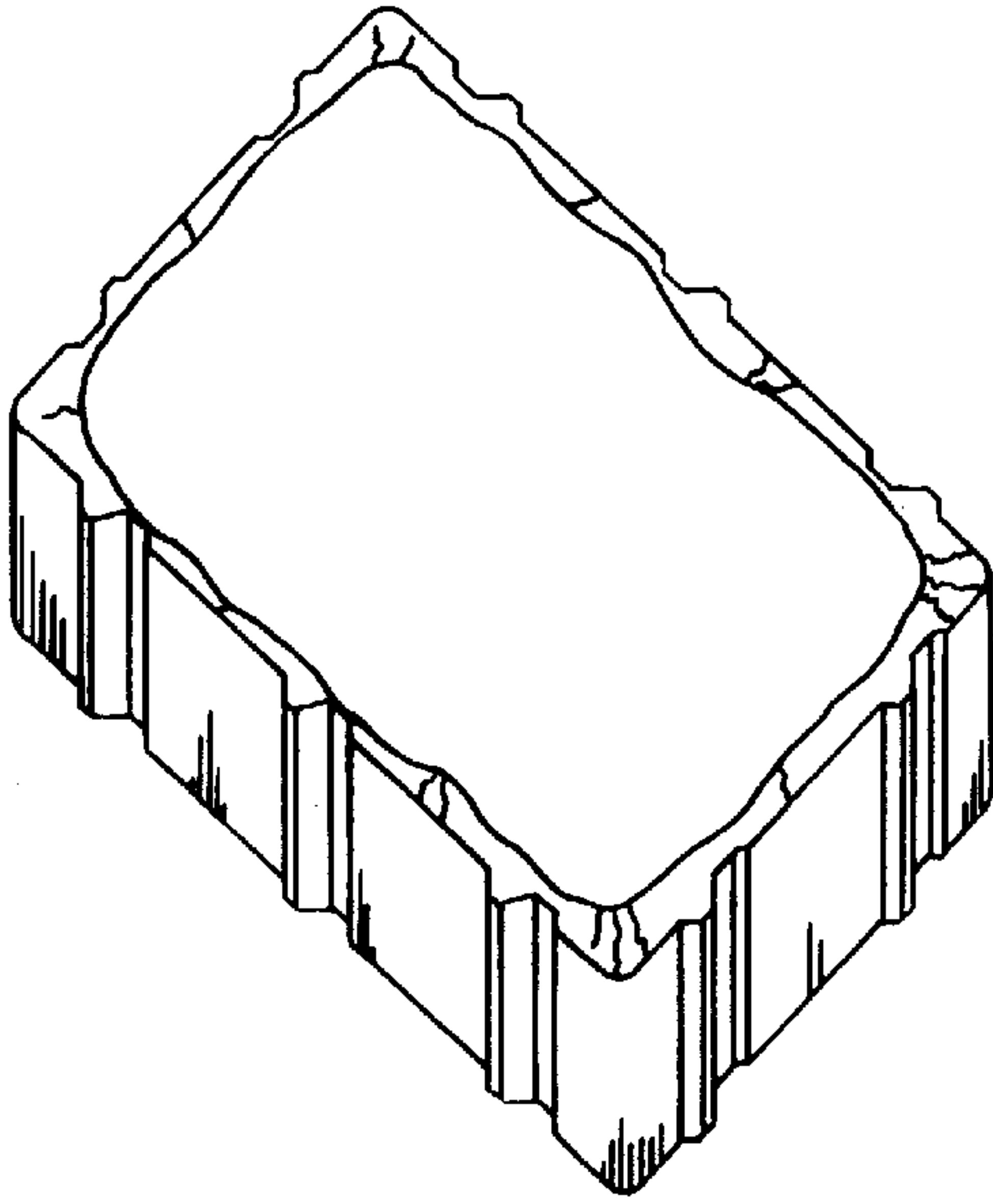

FIG. 26

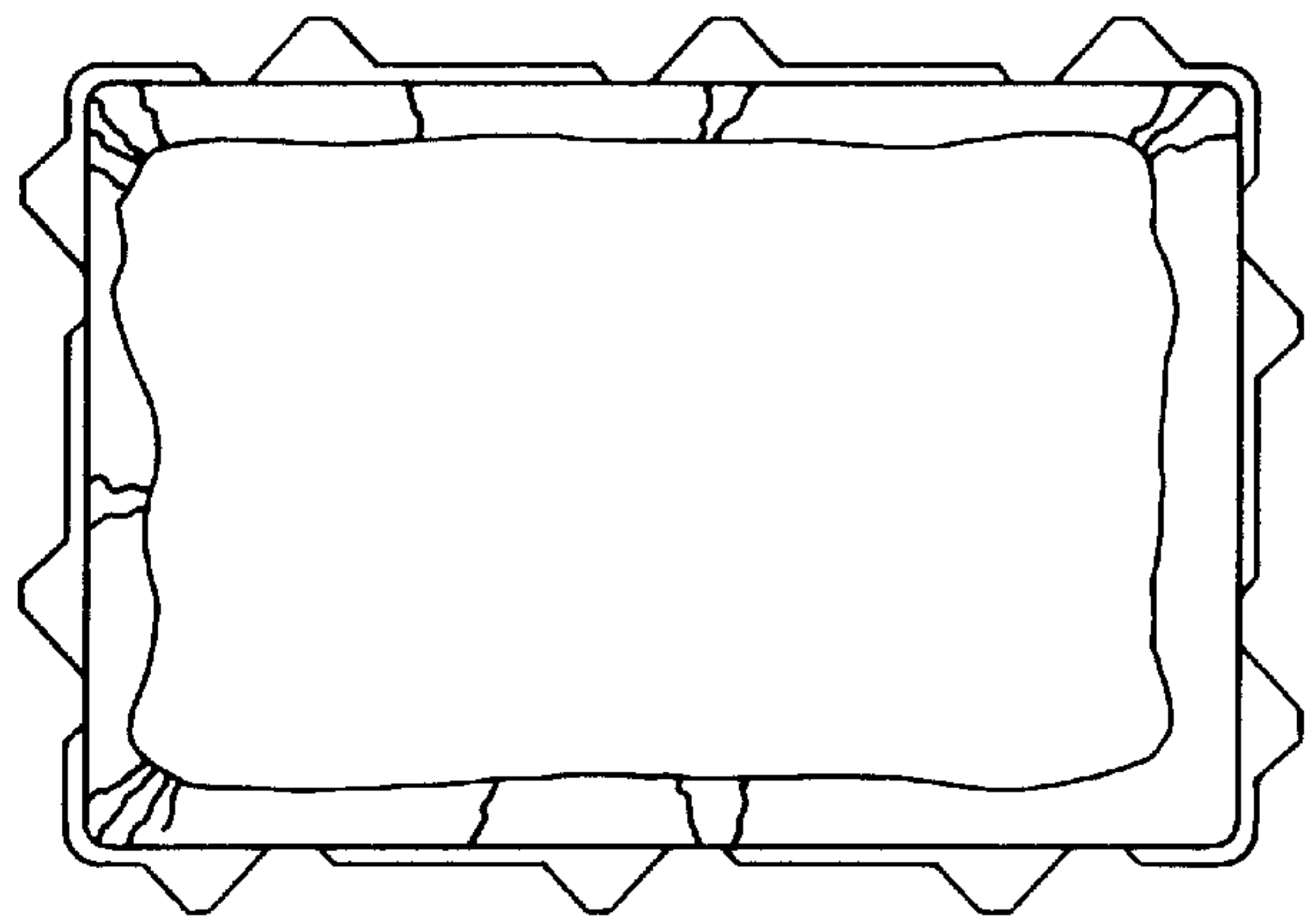

FIG. 29

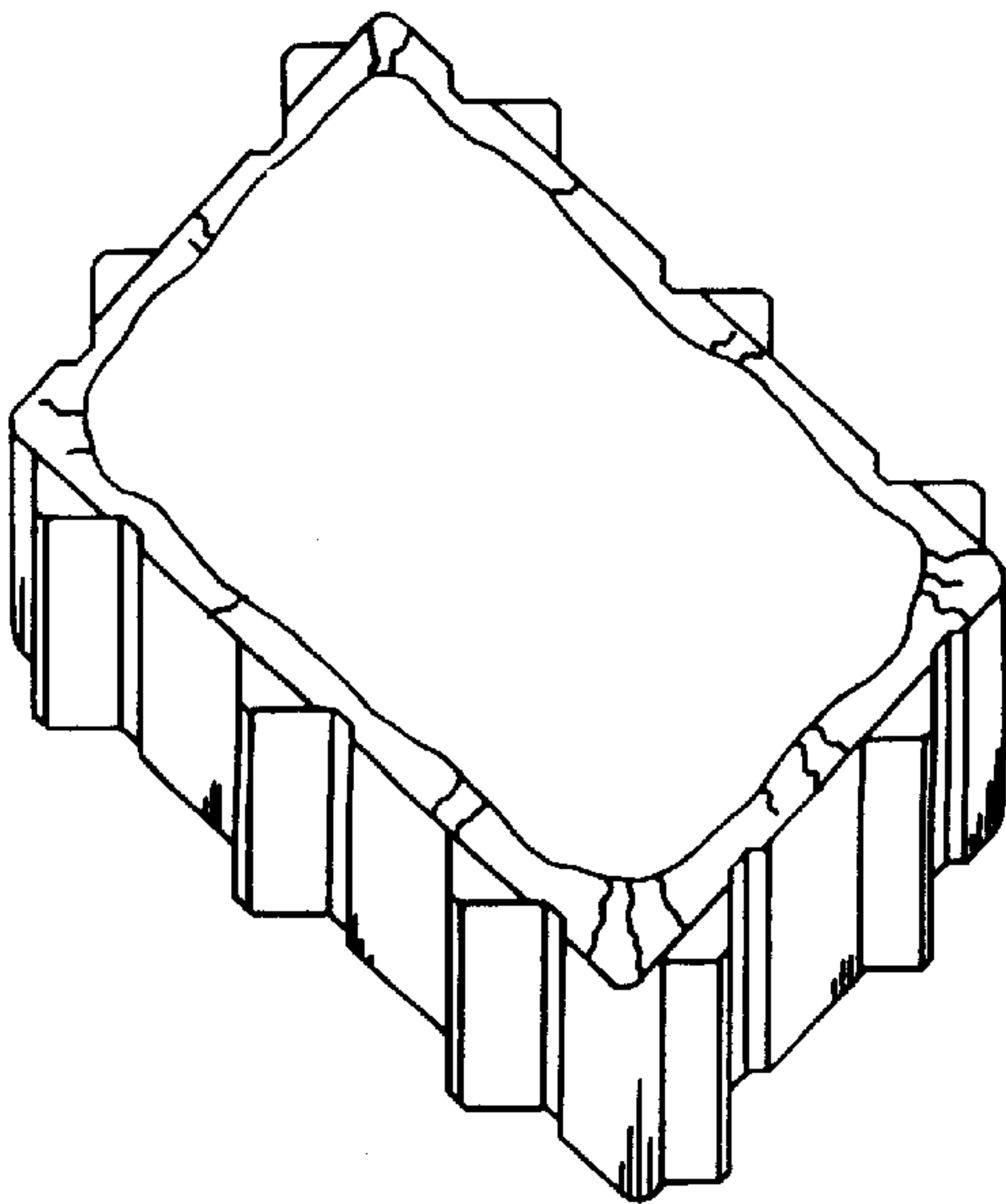

FIG. 31

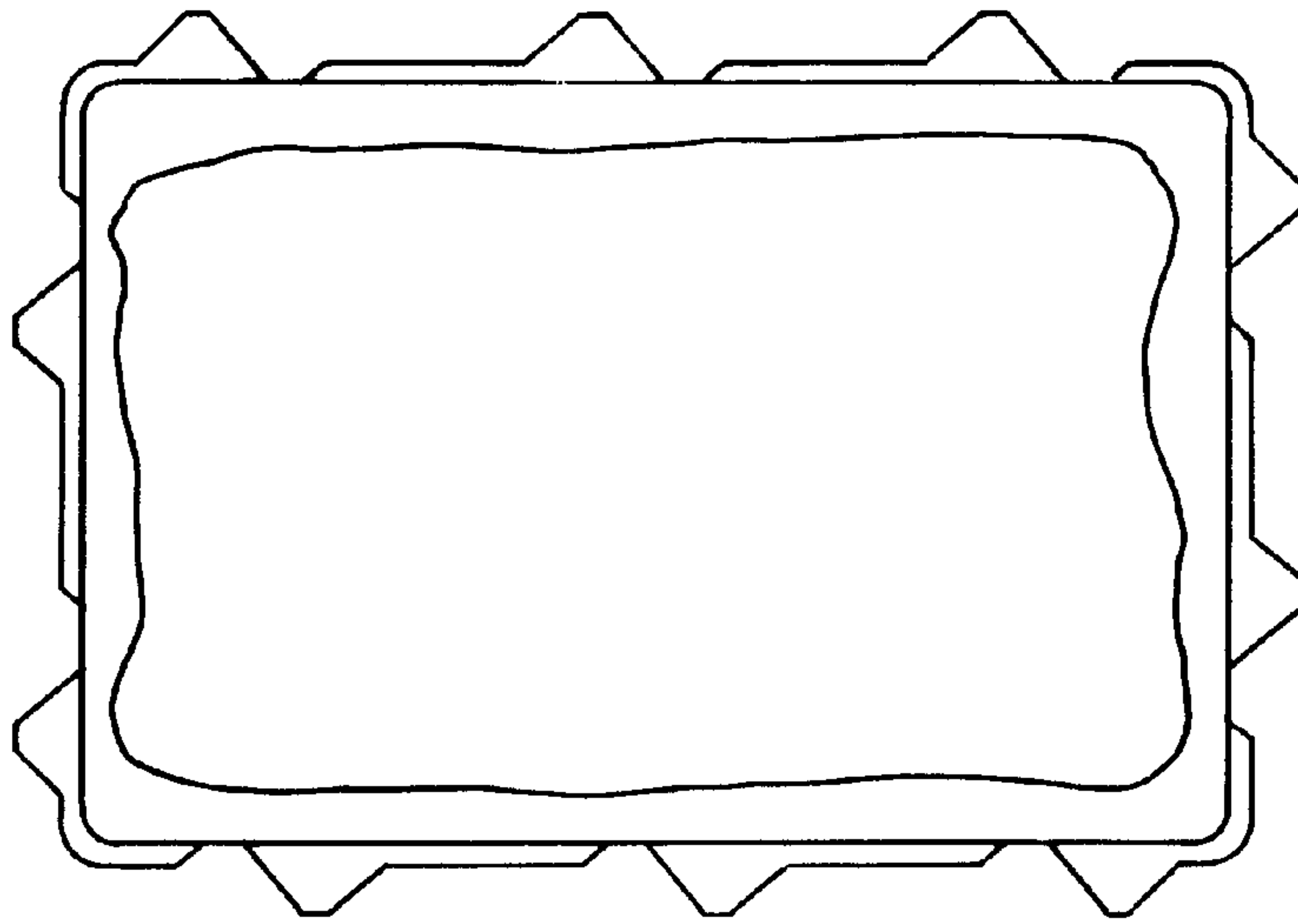

FIG. 30

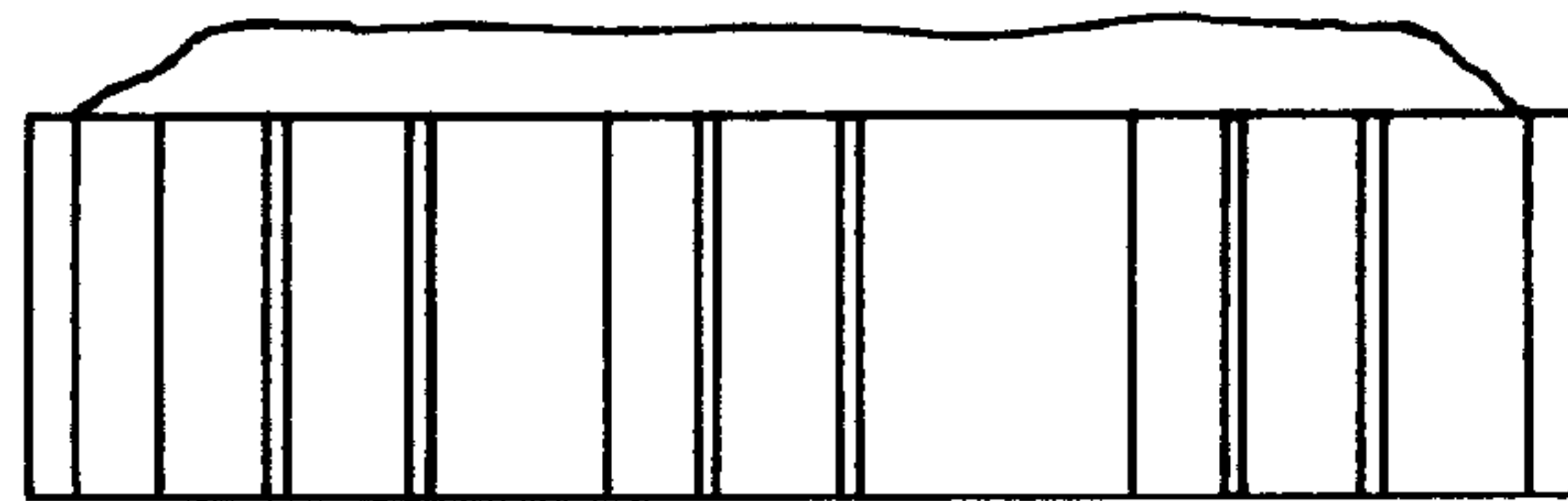

FIG. 32

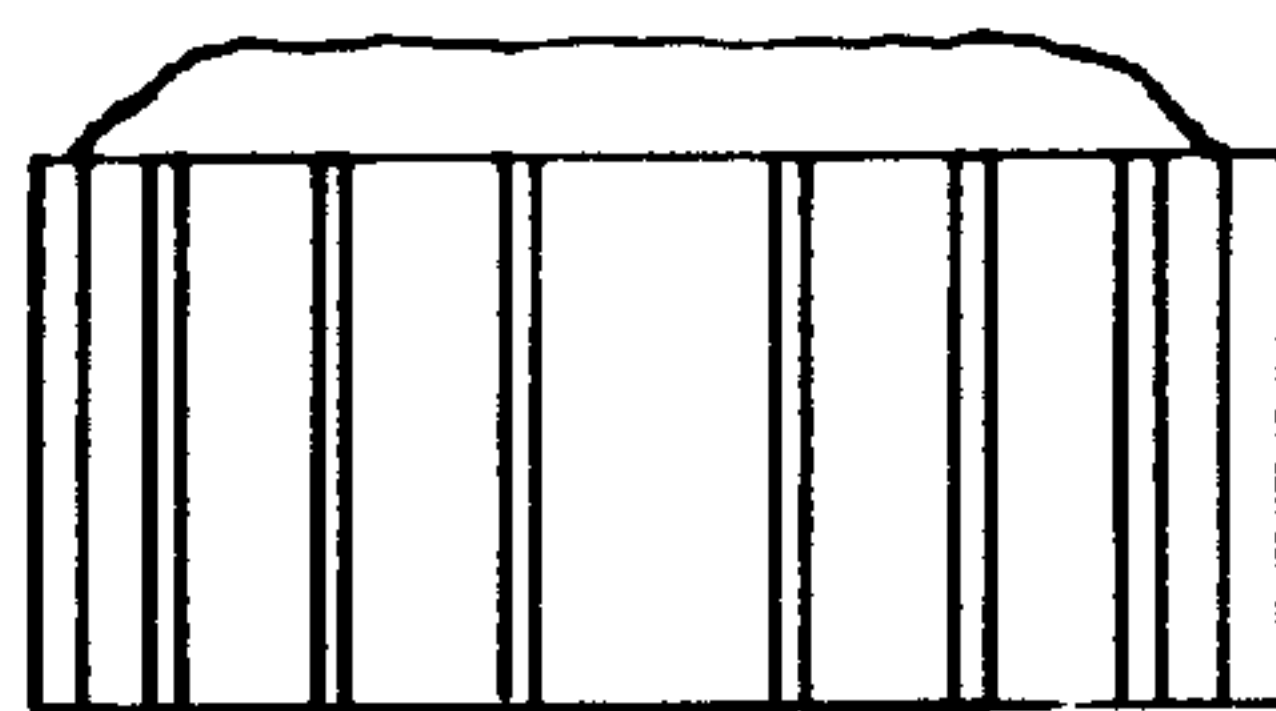

FIG. 33