



US00D431278S

United States Patent [19]

Tse

[11] Patent Number: **Des. 431,278**

[45] Date of Patent: **** Sep. 26, 2000**

[54] **SHOWER HEAD**

[75] Inventor: **Hing Fai Tse**, Tai Po, The Hong Kong Special Administrative Region of the People's Republic of China

[73] Assignee: **Brand New Technology, Ltd.**, Kowloon, The Hong Kong Special Administrative Region of the People's Republic of China

[**] Term: **14 Years**

[21] Appl. No.: **29/094,341**

[22] Filed: **Sep. 30, 1998**

[51] **LOC (7) Cl.** **23-01**

[52] **U.S. Cl.** **D23/223**

[58] **Field of Search** D23/213, 223, 226-228, 230; 239/394, 460-2, 556, 560

D. 348,720 7/1994 Haug et al. D23/22
D. 352,347 11/1994 Dannenberg D23/223
D. 374,477 10/1996 Dow et al. D23/223
D. 381,737 7/1997 Chan D23/223
D. 399,301 10/1998 Huen D23/223

Primary Examiner—Robin V. Taylor
Attorney, Agent, or Firm—Leydig, Voit & Mayer, Ltd.

[57] CLAIM

The ornamental design for a shower head, as shown and described.

DESCRIPTION

FIG. 1 is a front, left side and bottom end perspective view of a shower head showing my new design;
FIG. 2 is a front elevational view thereof;
FIG. 3 is a rear elevational view thereof;
FIG. 4 is a left side elevational view thereof;
FIG. 5 is a left side elevational view thereof;
FIG. 6 is a top end elevational view thereof; and,
FIG. 7 is a bottom end elevational view thereof.

[56] References Cited

U.S. PATENT DOCUMENTS

D. 339,627 9/1993 Klose D23/223

1 Claim, 4 Drawing Sheets

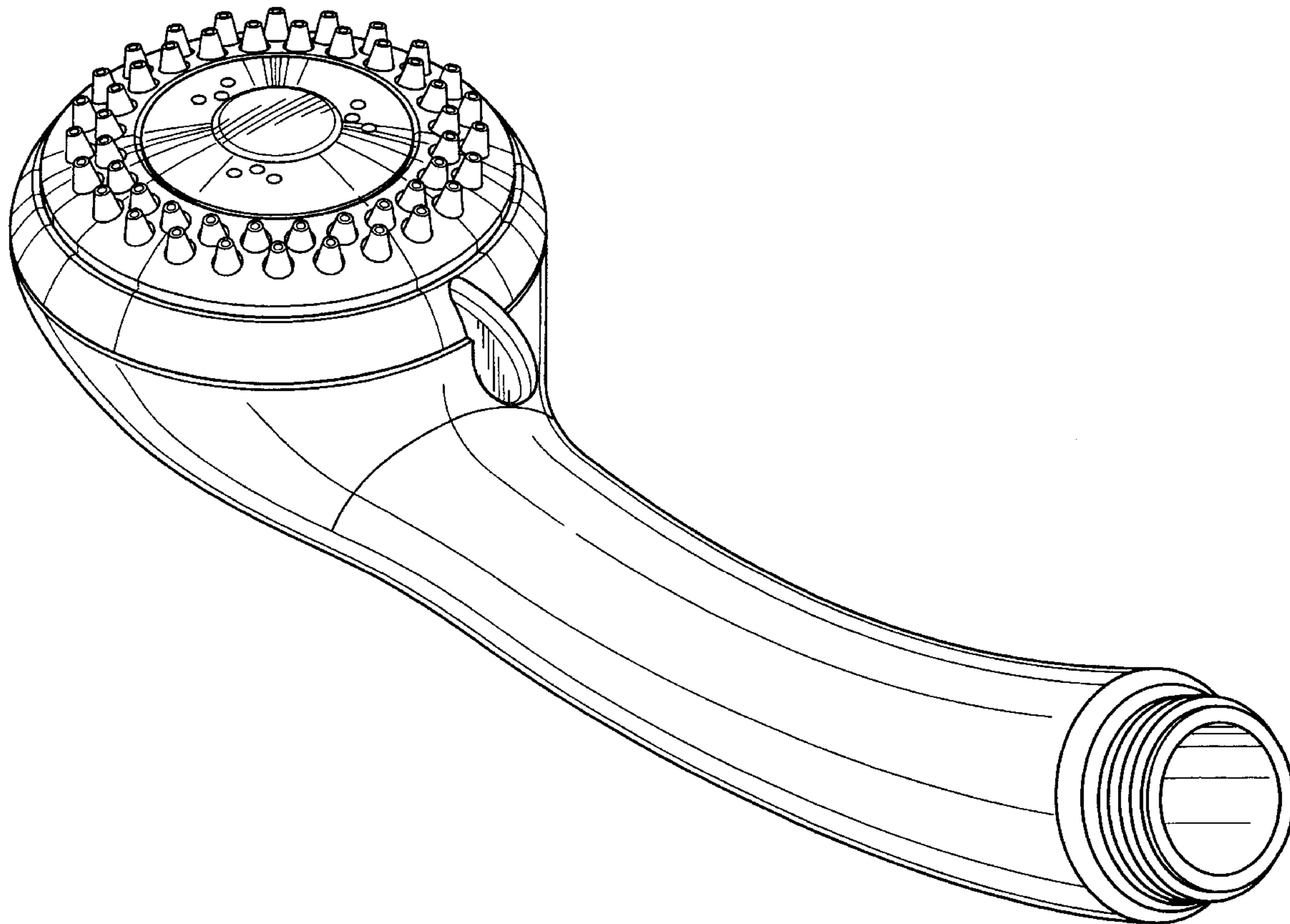

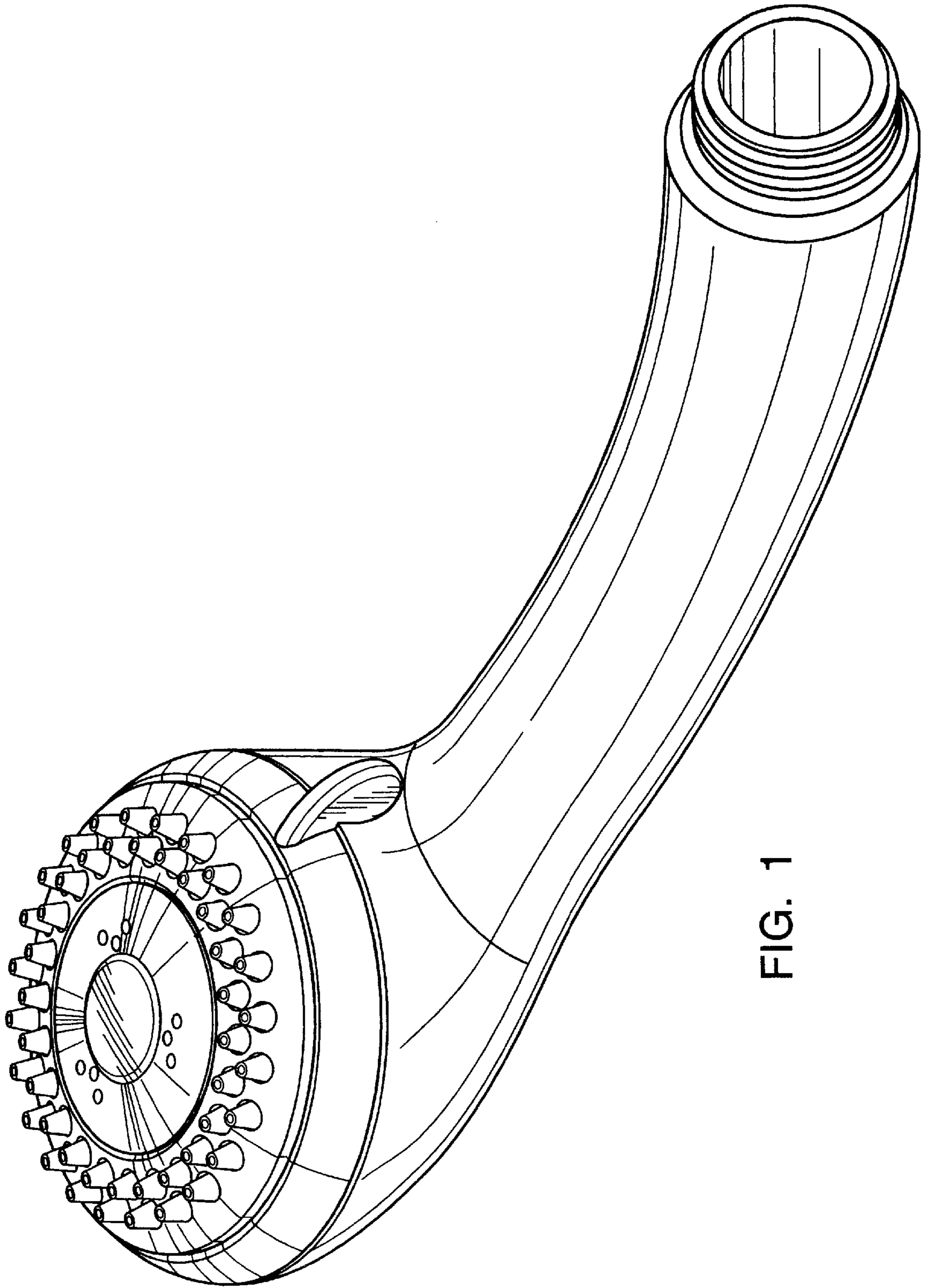

FIG. 1

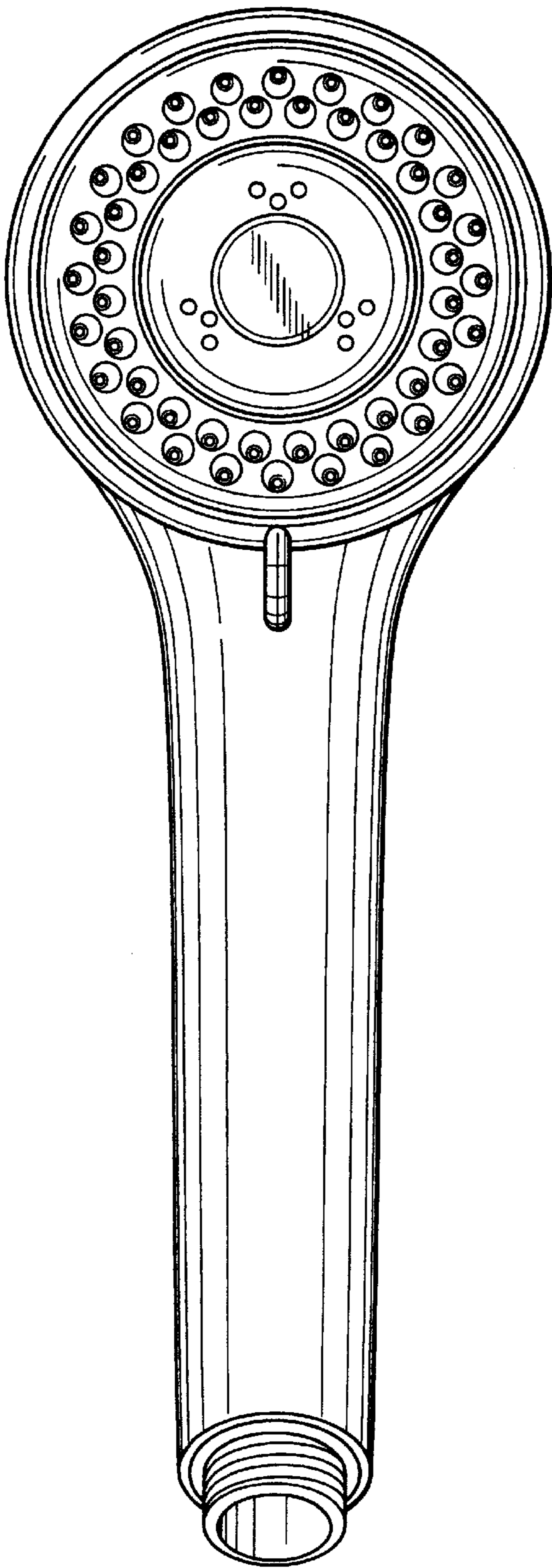

FIG. 2

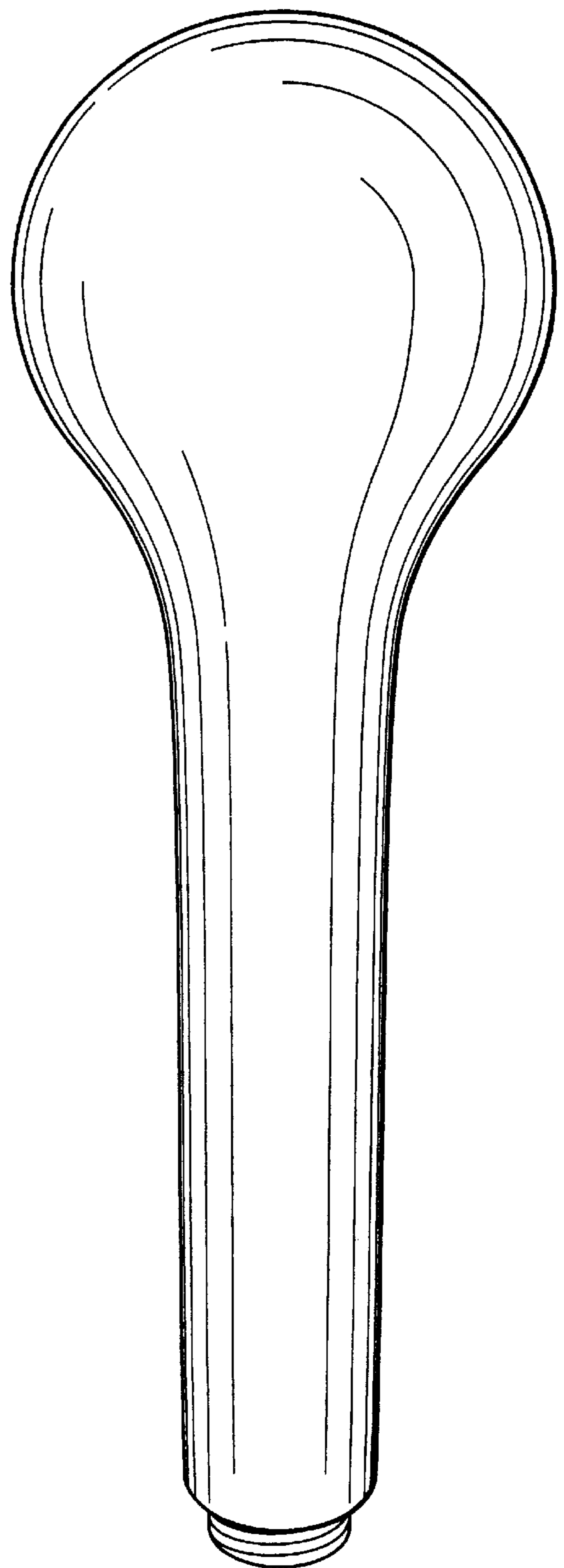

FIG. 3

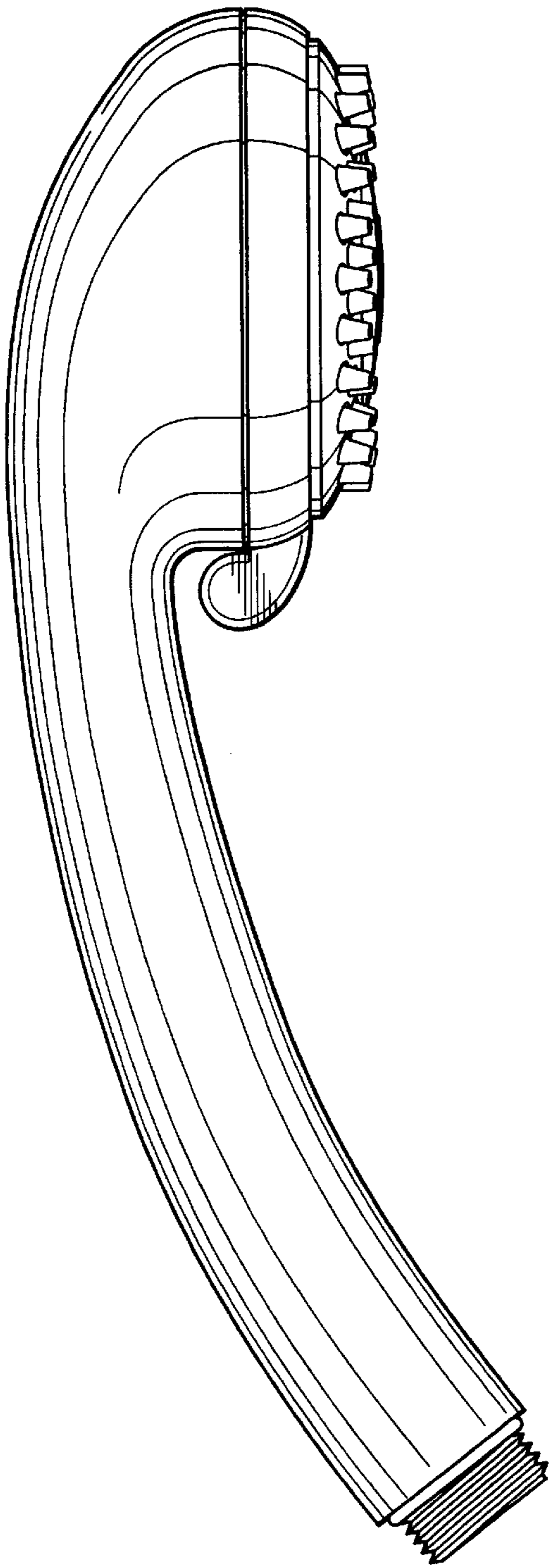

FIG. 4

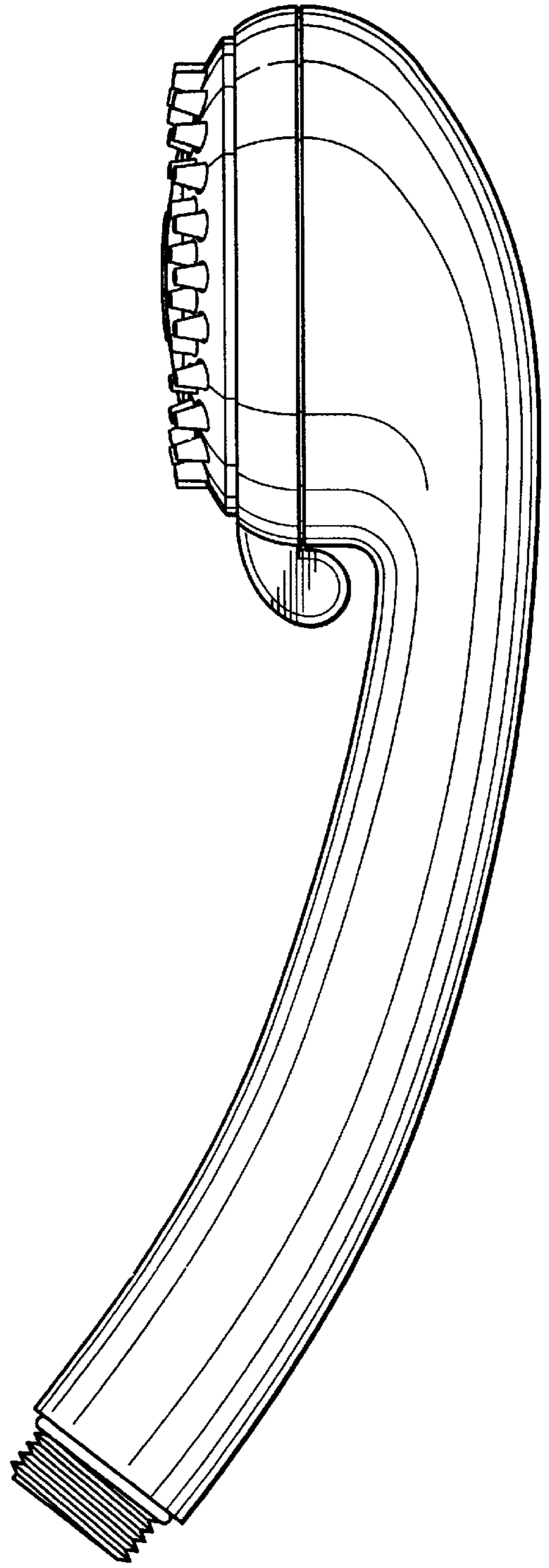

FIG. 5

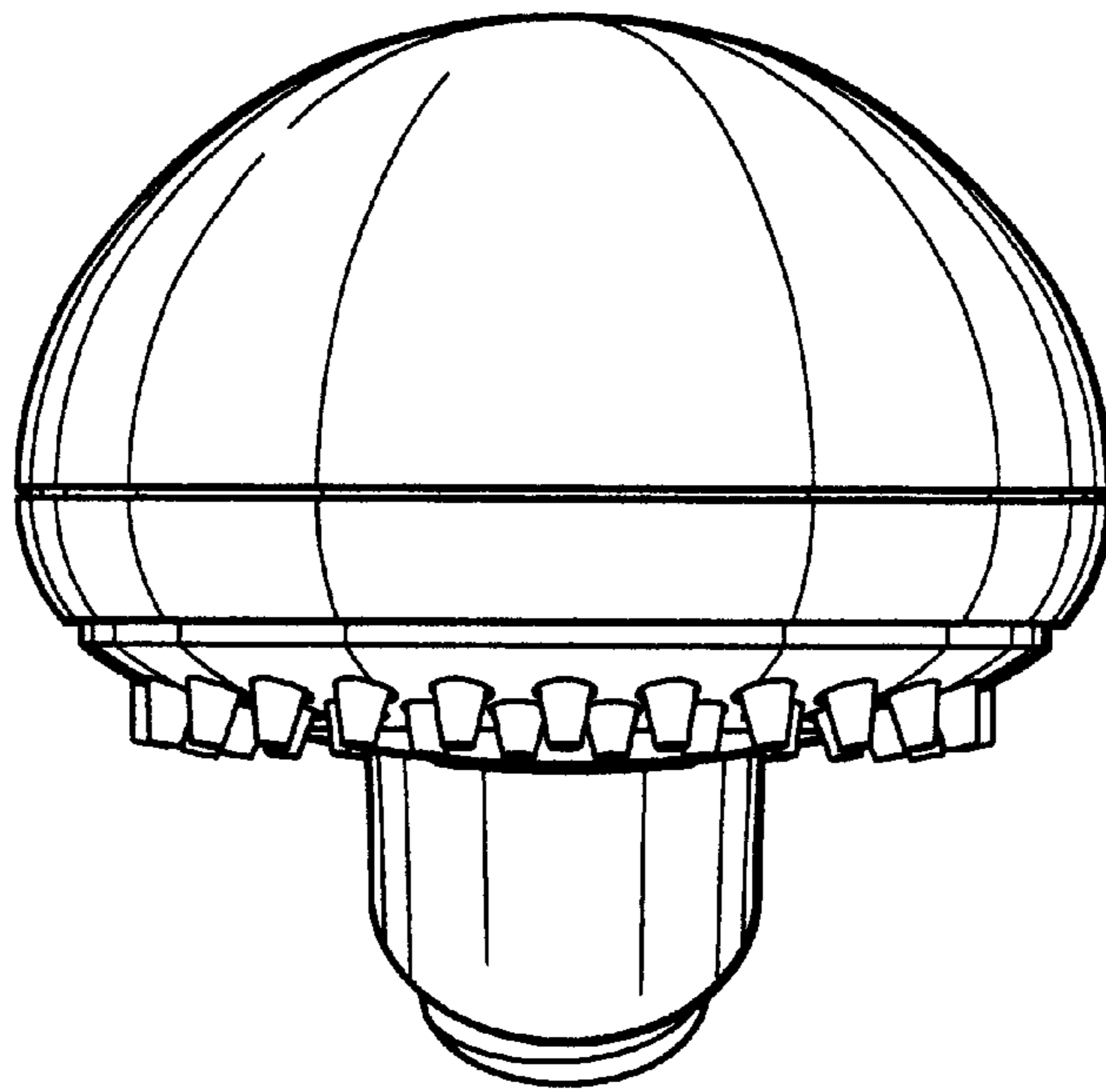

FIG. 6

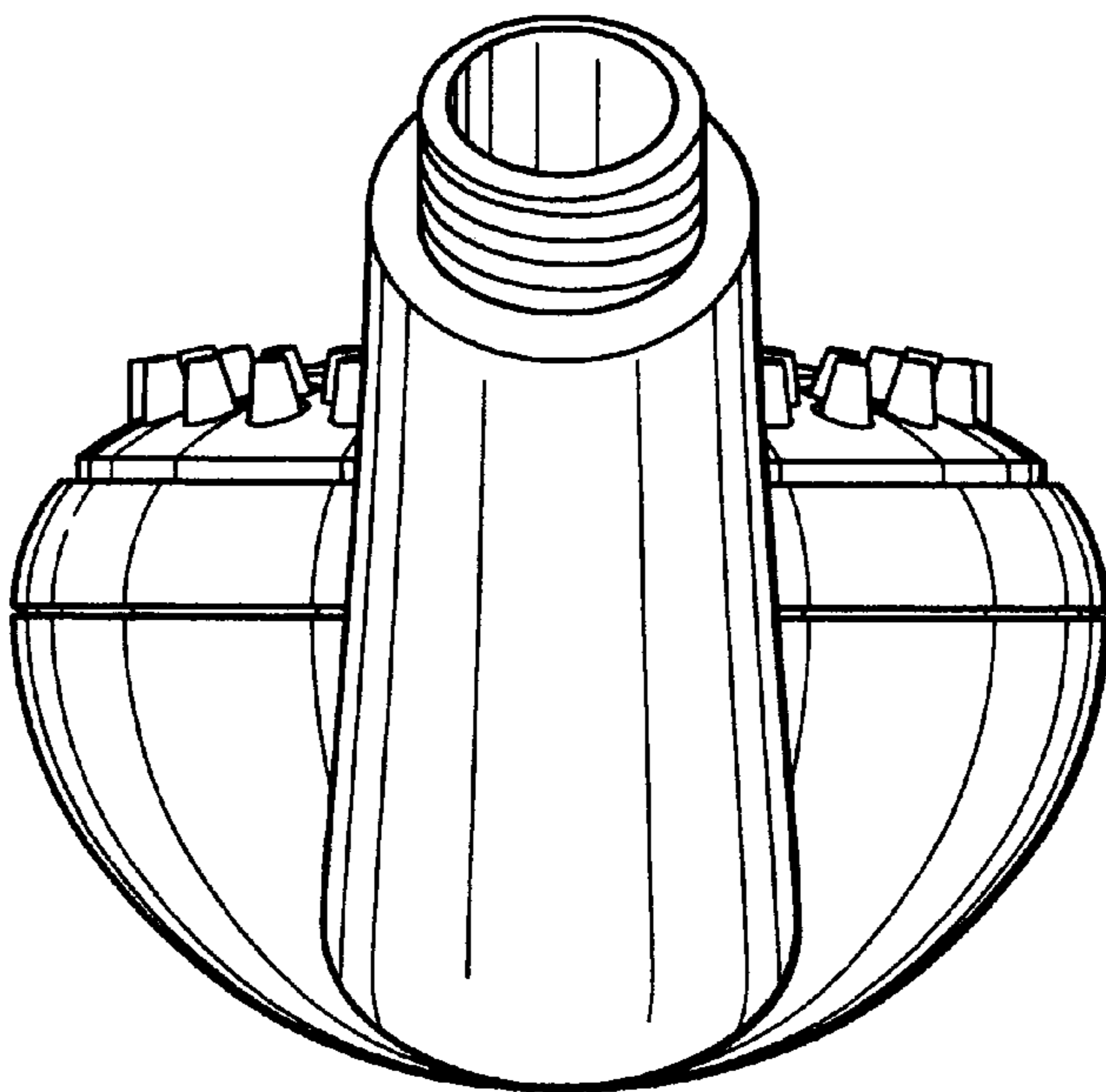

FIG. 7