



US00D431258S

United States Patent [19]
Simioni et al.

[11] **Patent Number: Des. 431,258**
[45] **Date of Patent: ** Sep. 26, 2000**

[54] **EYEWEAR**

D. 411,560 6/1999 Arnette D16/321

[76] Inventors: **Luciano Simioni**, Via S. Maria in Colle, 23, 31044 Montebelluna (Prov. of Treviso); **Marco Damin**, Via Alesandra Manzoni, 31, Pianiga, (Ve), both of Italy

OTHER PUBLICATIONS

Intl Designs Bulletin DM/041982, FIGS. 1.1–1.7, Nov. 5, 1997.
Outside Buyer's Guide 1998, p. 90, *Bolle* design.
Arnette Optic Illusions Catalog, 1998, *Swinger*.
Arnette Optic Illusions Catalog, 1998, *Raven*.
Arnette Optic Illusions Catalog, 1998, *Catfish*.
Bausch & Lomb's Ray-Ban Catalog, 1999, *Rituals Illusion* design.
Suncloud's Catalog, 1998, *Sport Cayenne, Mesa*, and I-70 designs.
Killer Loop Catalog, 1997, *Spasm*, all designs.
Killer Loop Catalog, 1999, *The Heist*, all designs.

[**] Term: **14 Years**

[21] Appl. No.: **29/103,229**

[22] Filed: **Apr. 12, 1999**

[30] **Foreign Application Priority Data**

Oct. 28, 1998 [XH] Hague Agreement DM/045583

[51] **LOC (7) Cl.** **16-06**

[52] **U.S. Cl.** **D16/326; D16/321**

[58] **Field of Search** D16/101, 300–330,
D16/335, 337; D29/109, 110; 351/41, 44,
51, 52, 111, 158; 2/447, 448

Primary Examiner—Raphael Barkai
Attorney, Agent, or Firm—Guido Modiano

[57] **CLAIM**

The ornamental design for eyewear, as shown and described.

[56] **References Cited**

DESCRIPTION

U.S. PATENT DOCUMENTS

- D. 192,884 5/1962 Petitto D16/326
- D. 235,164 5/1975 Shindler D16/335
- D. 371,382 7/1996 Berthet-Bondet D16/337
- D. 392,307 3/1998 Wilson D16/326
- D. 397,351 8/1998 Simioni D16/326
- D. 399,239 10/1998 Jannard et al. D16/326
- D. 400,229 10/1998 Arnette D16/321
- D. 407,736 4/1999 Simioni D16/326

FIG. 1 is a front perspective view of eyewear showing my new design;
FIG. 2 is a front elevational view thereof;
FIG. 3 is a rear elevational view thereof;
FIG. 4 is a side elevational view thereof;
FIG. 5 is a top plan view thereof; and,
FIG. 6 is a bottom plan view thereof.

1 Claim, 6 Drawing Sheets

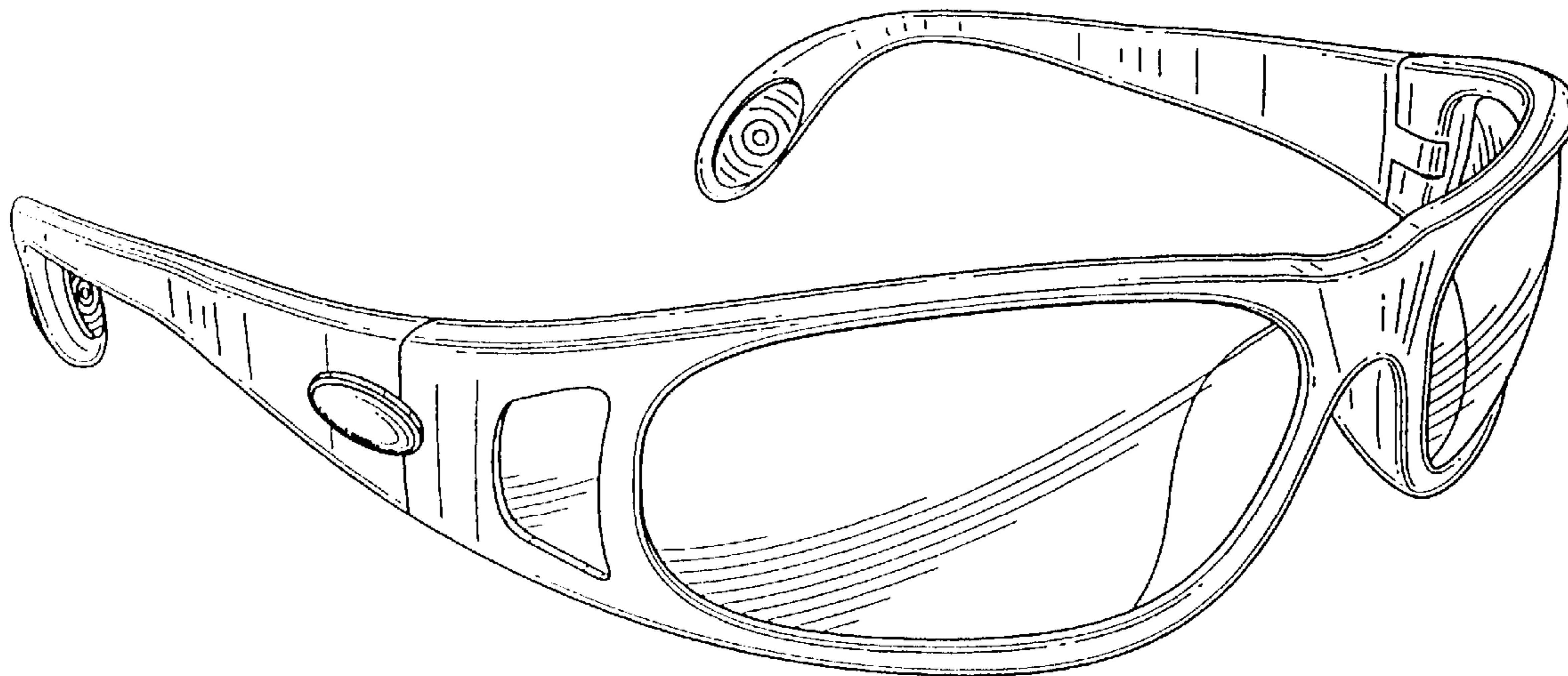

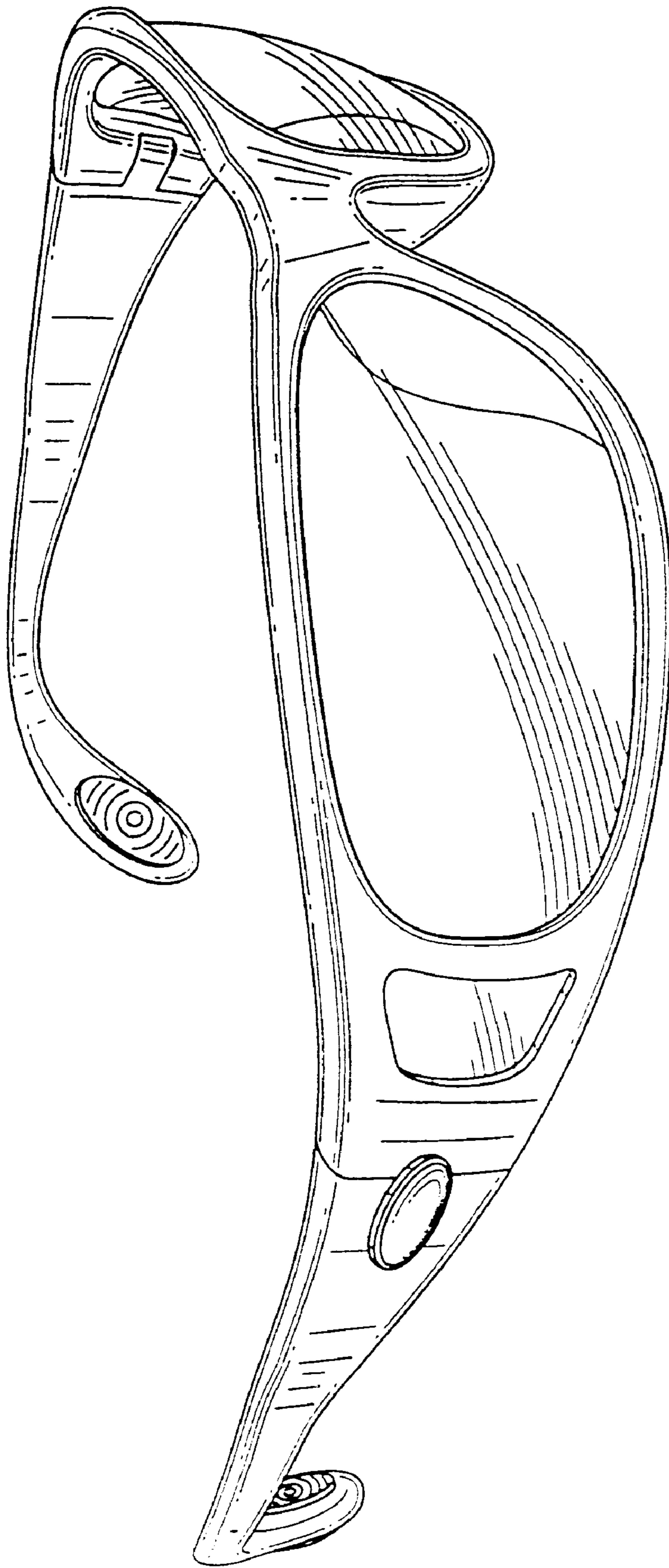

FIG. 1

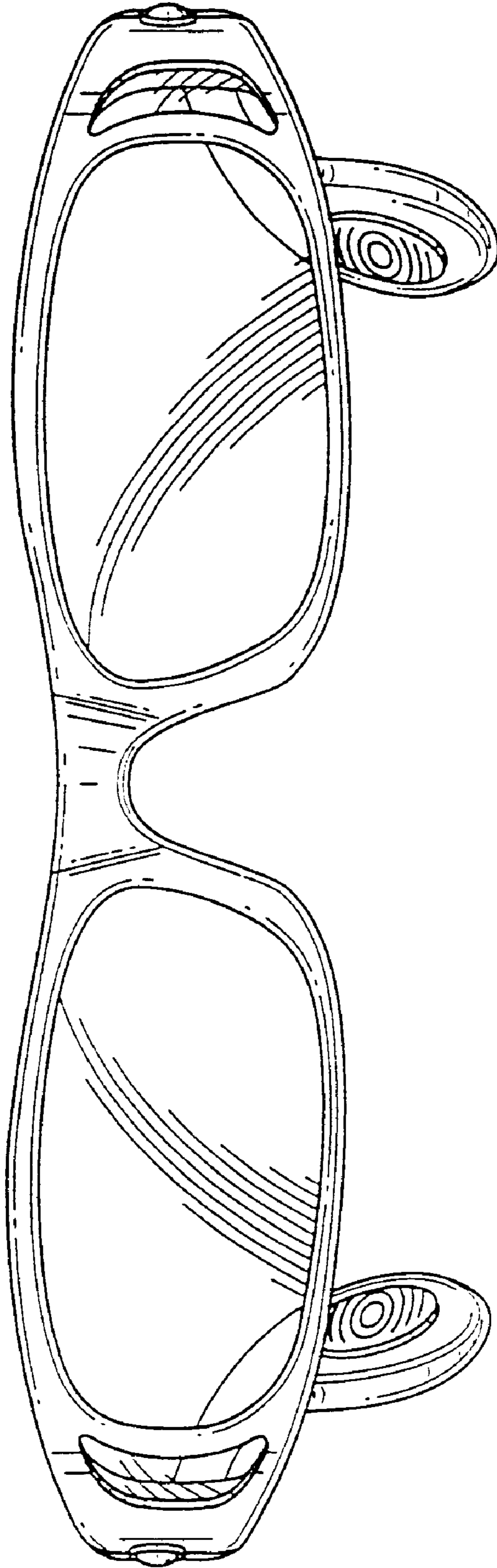

FIG. 2

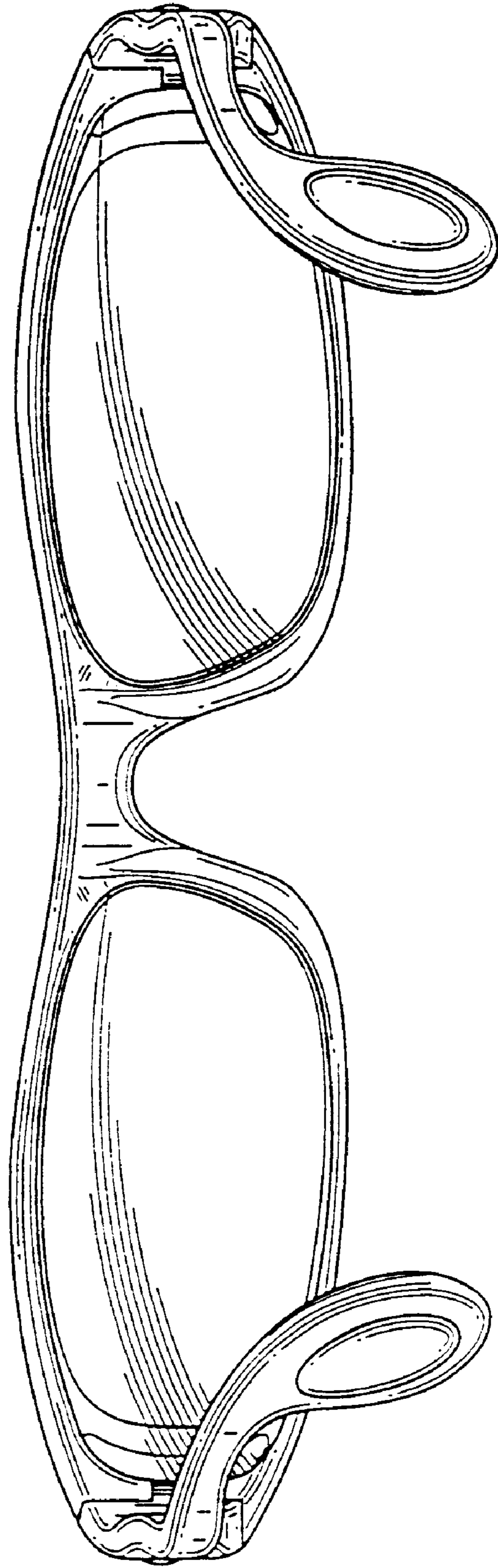

FIG. 3

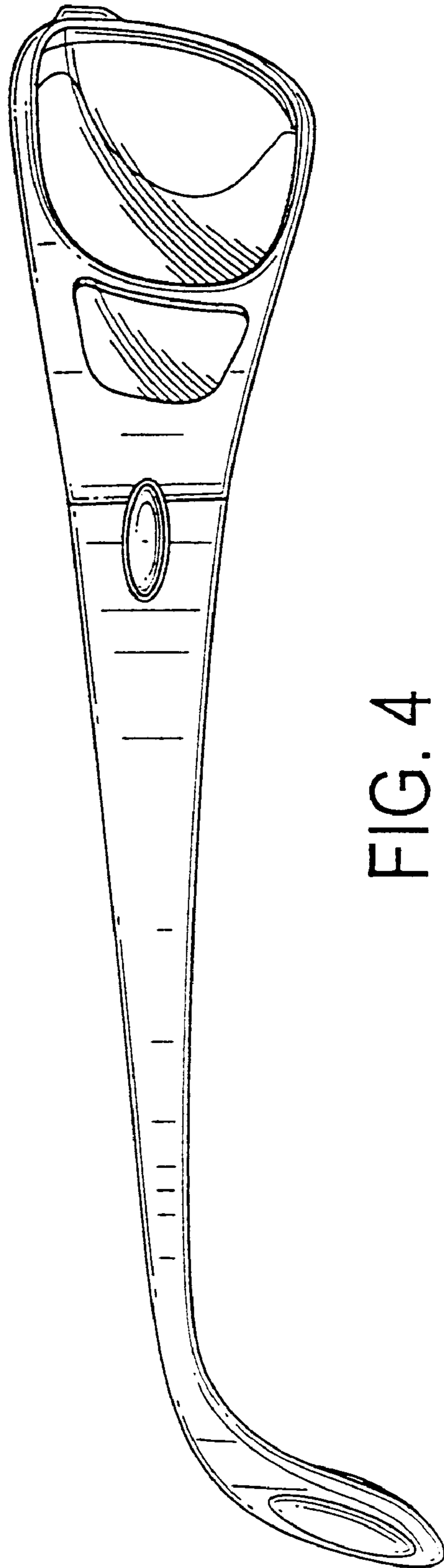

FIG. 4

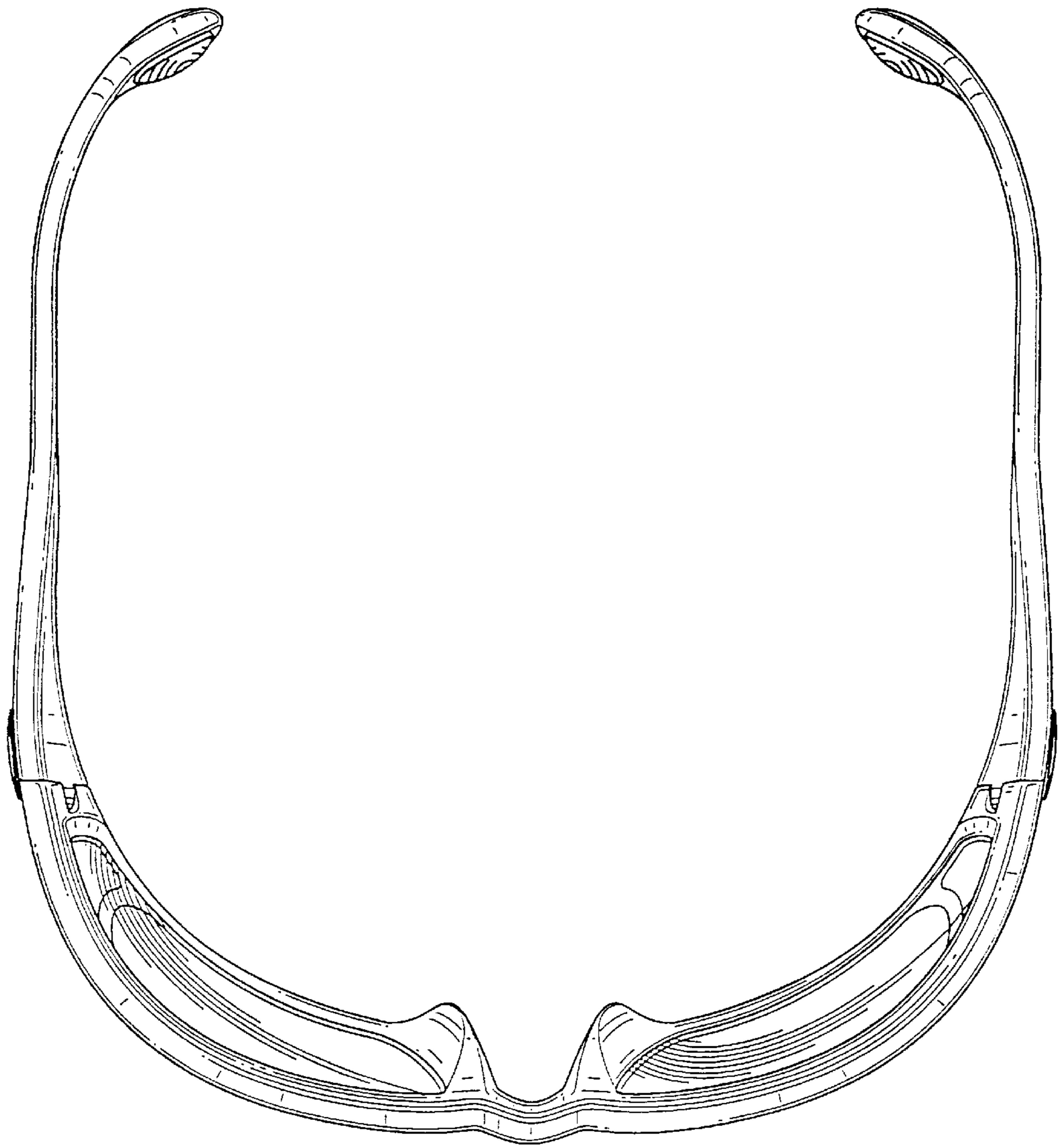

FIG. 5

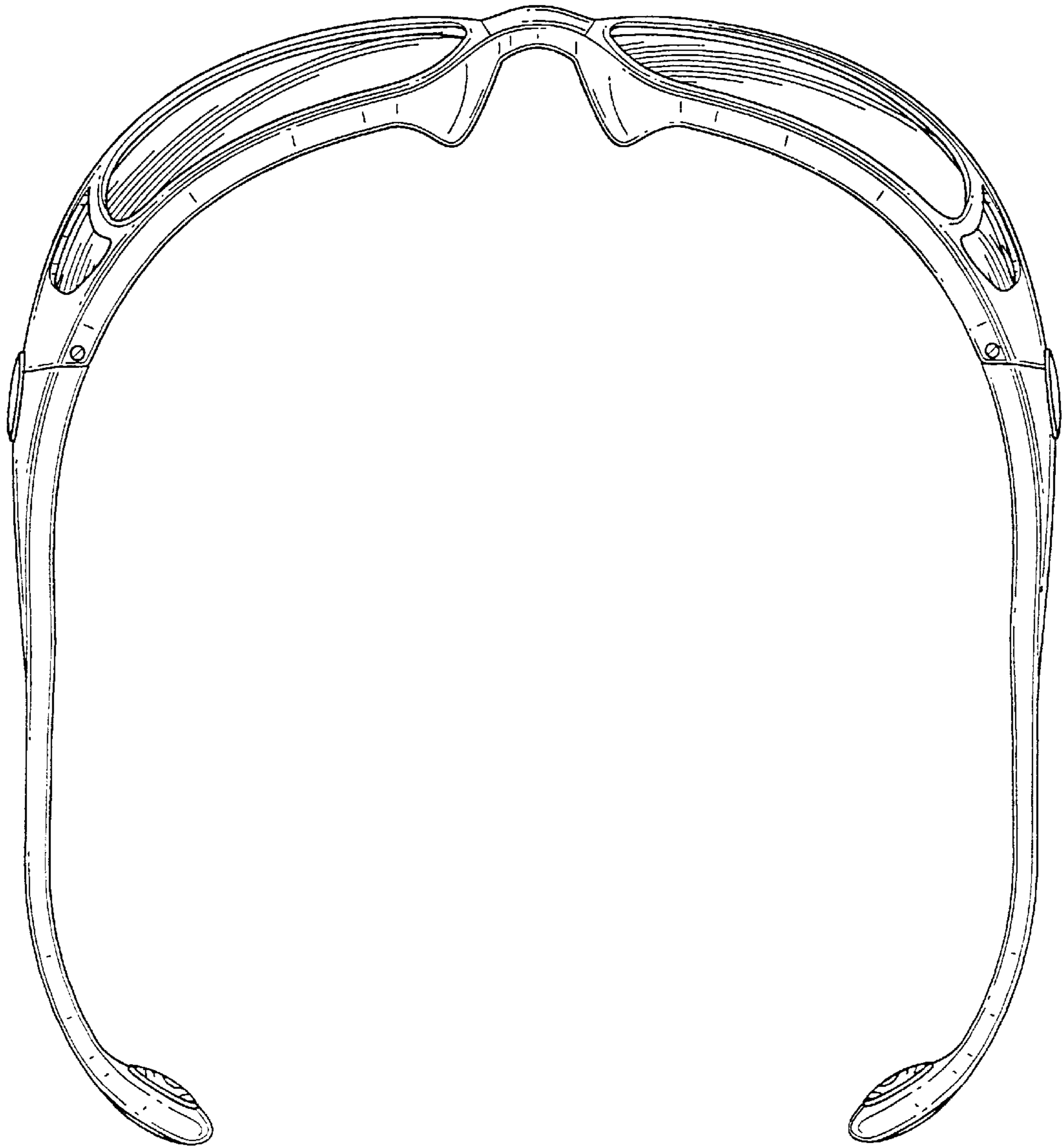

FIG. 6