



US00D431211S

United States Patent [19]

[11] Patent Number: Des. 431,211

Hoop et al.

[45] Date of Patent: ** Sep. 26, 2000

[54] PAIR OF MOTORCYCLE FAIRING GUARDS

[76] Inventors: Mark R. Hoop; Lisa J. Hoop, both of 693 Carlsbad Rd., Cincinnati, Ohio 45240

[**] Term: 14 Years

[21] Appl. No.: 29/120,869

[22] Filed: Mar. 28, 2000

[51] LOC (7) Cl. 12-11

[52] U.S. Cl. D12/126

[58] Field of Search D12/114, 110, D12/126, 182, 199; 180/219; 280/288.4, 304.3; 296/78.1

[56] **References Cited**

U.S. PATENT DOCUMENTS

D. 82,395	10/1930	Schulman	D12/199
D. 84,659	7/1931	Schnell et al.	D12/199
D. 170,248	10/1953	Sundberg	D12/199 X
D. 311,715	10/1990	Yamada et al.	D12/182
D. 388,387	12/1997	Vetter	D12/182

OTHER PUBLICATIONS

Custom Chrome, 'Live To Ride' Medallion, p. 15.67, 1999.
Harley-Davidson ® Genuine Motor Accessories™ & Genuine Motor Parts™, eagle fairing decals, p. 299, 1999.

Primary Examiner—Alan P. Douglas
Assistant Examiner—Linda Brooks
Attorney, Agent, or Firm—Alfred J. Mangels

[57] **CLAIM**

The ornamental design for a pair of motorcycle fairing guards, as shown and described.

DESCRIPTION

FIG. 1 is a front view of a motorcycle front fairing on which are mounted a pair of motorcycle fairing guards in accordance with our new design, wherein the motorcycle front fairing is shown in dashed lines and forms no part of our invention.

FIG. 2 is an enlarged front elevational view of the right hand fairing guard of the pair of motorcycle fairing guards, shown separately for ease of illustration.

FIG. 3 is a left end view of FIG. 2.

FIG. 4 is a right end view of FIG. 2.

FIG. 5 is a top view of FIG. 2.

FIG. 6 is a bottom view of FIG. 2.

FIG. 7 is a rear elevational view of FIG. 2.

FIG. 8 is a cross-sectional view thereof taken along the line 8—8 of FIG. 2; and,

FIG. 9 is a cross-sectional view thereof taken along the line 9—9 of FIG. 2.

The left hand fairing guard of the pair of motorcycle fairing guards is a mirror image of the right hand fairing guard.

1 Claim, 6 Drawing Sheets

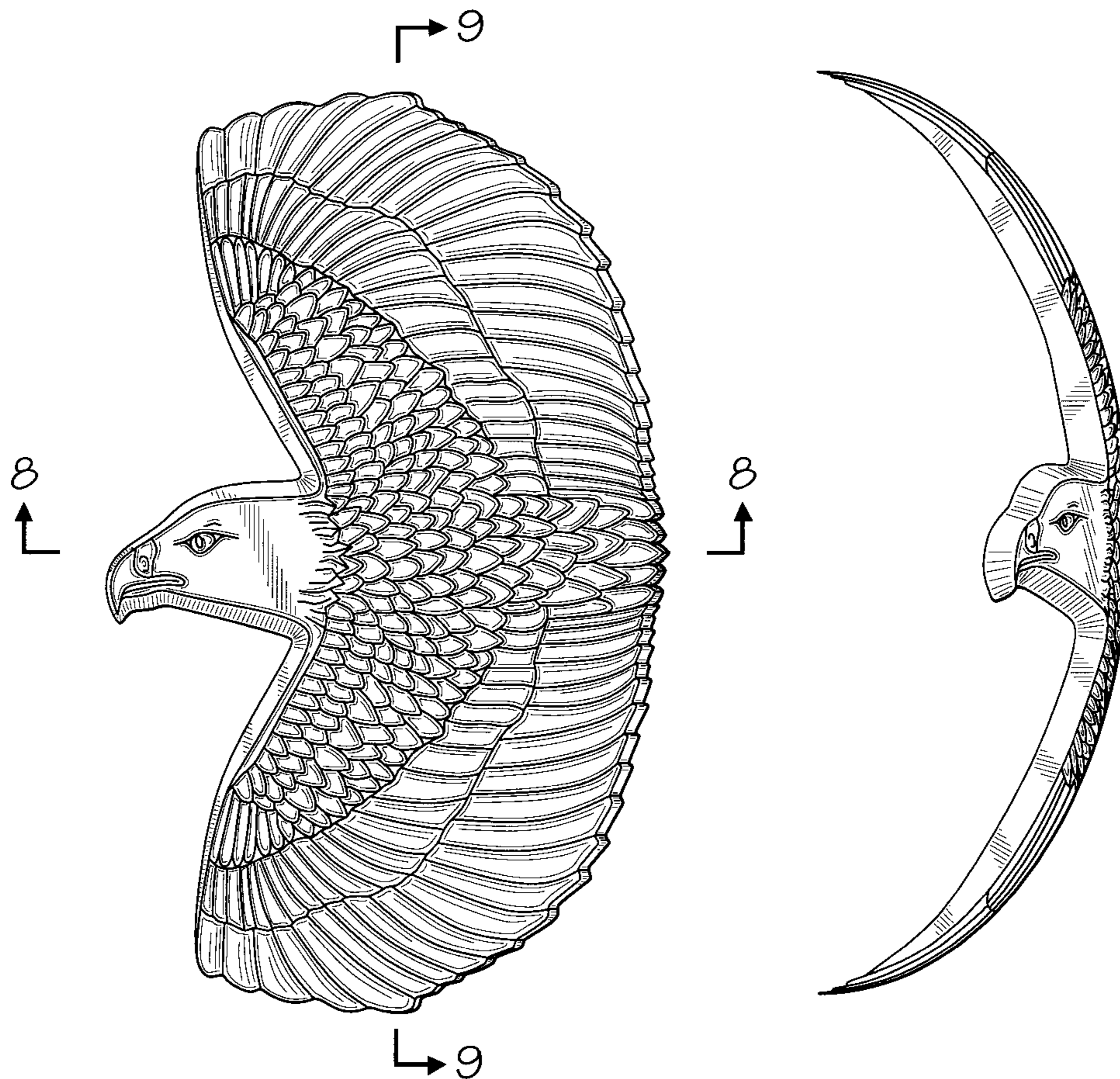

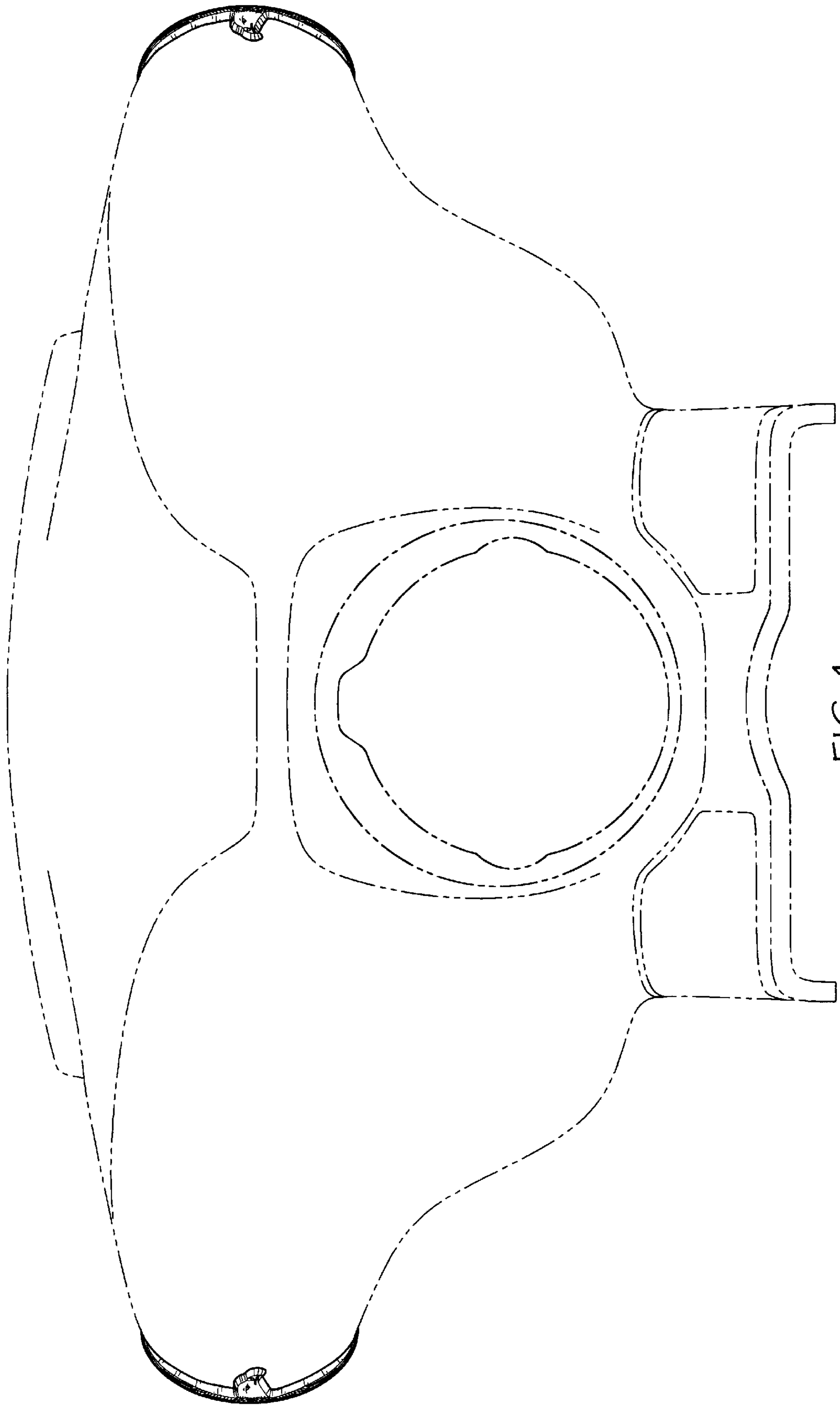

FIG. 1

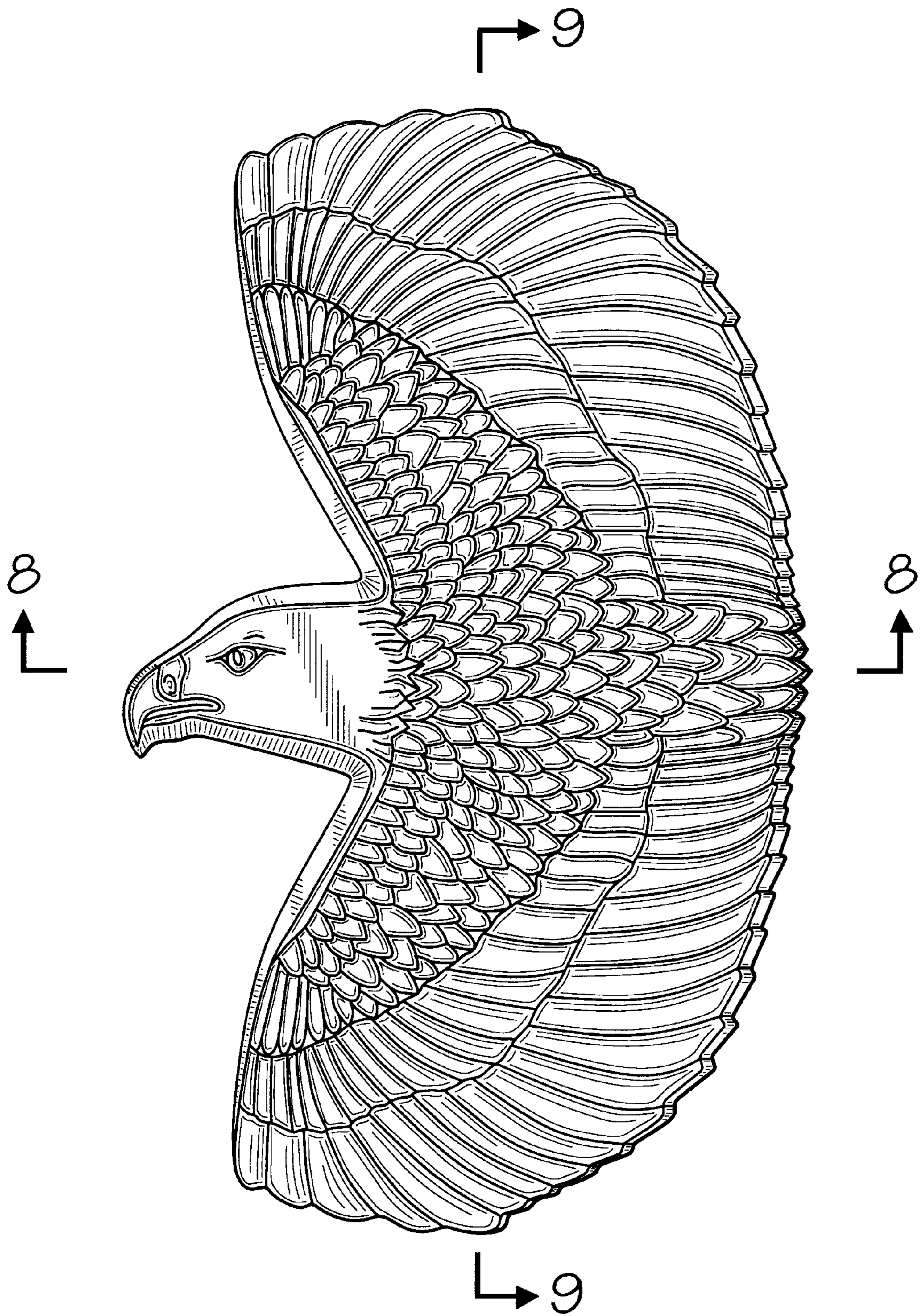

FIG. 2

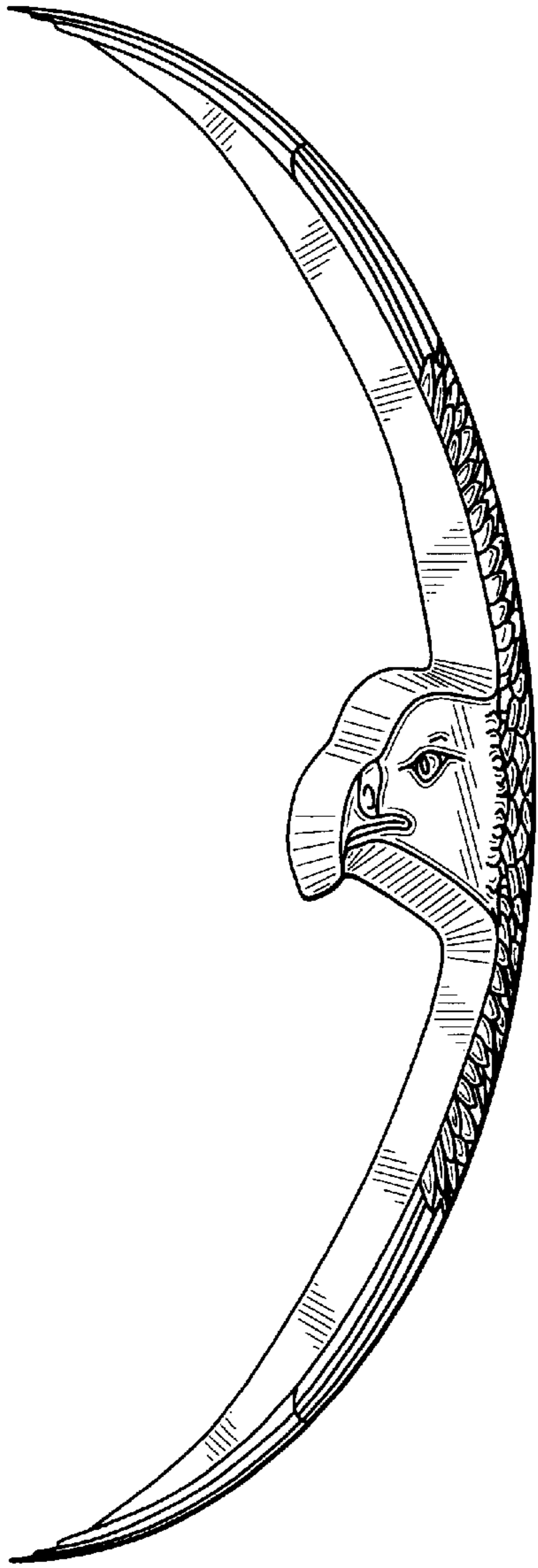

FIG. 3

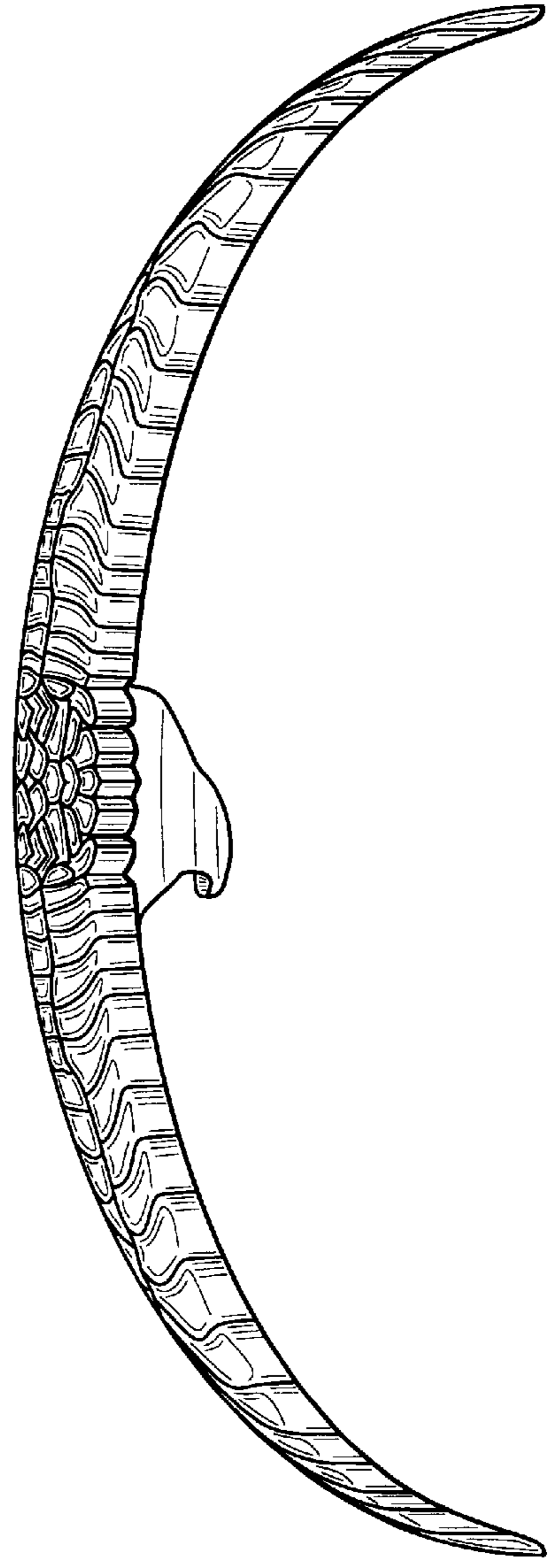

FIG. 4

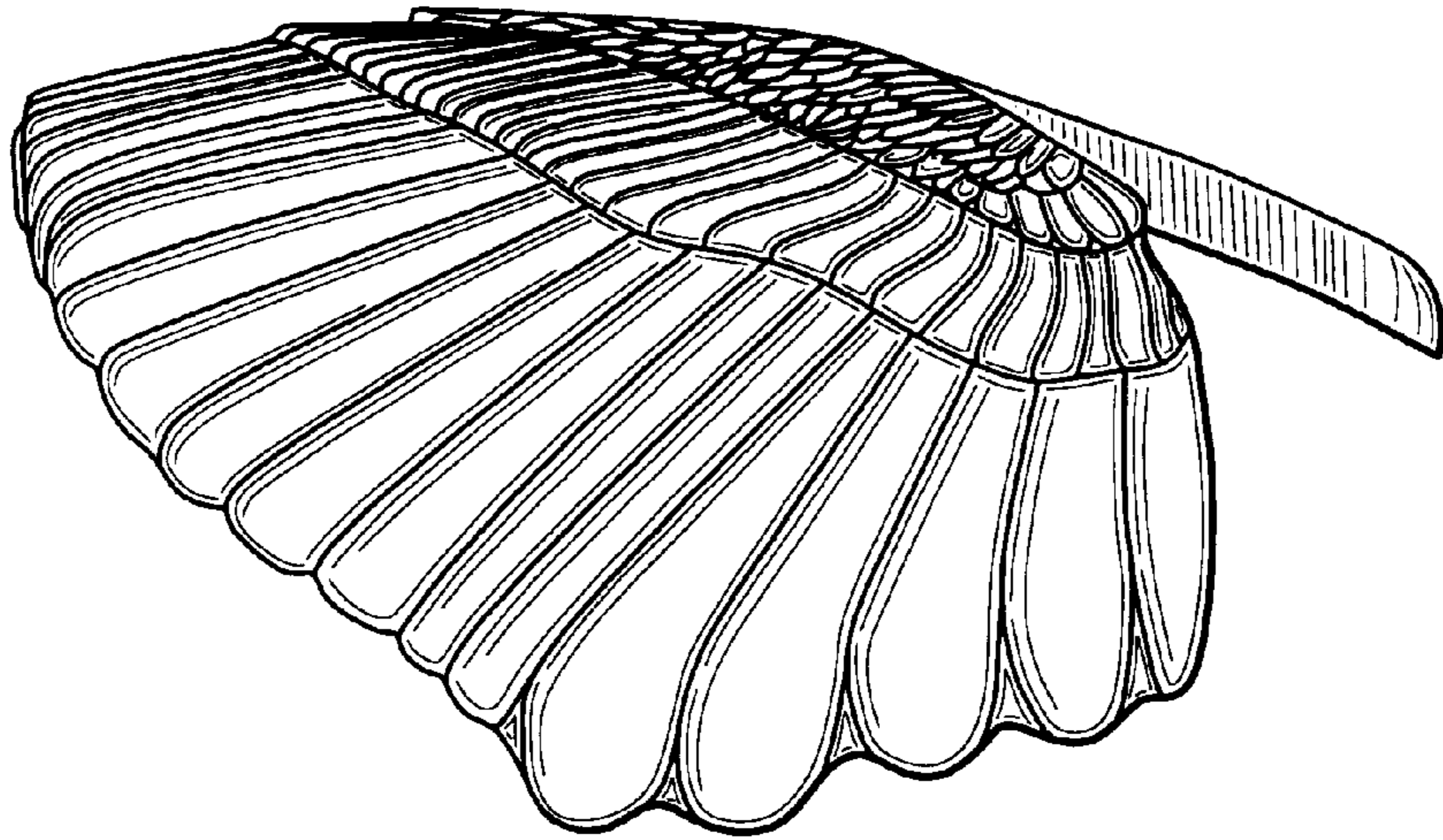

FIG. 5

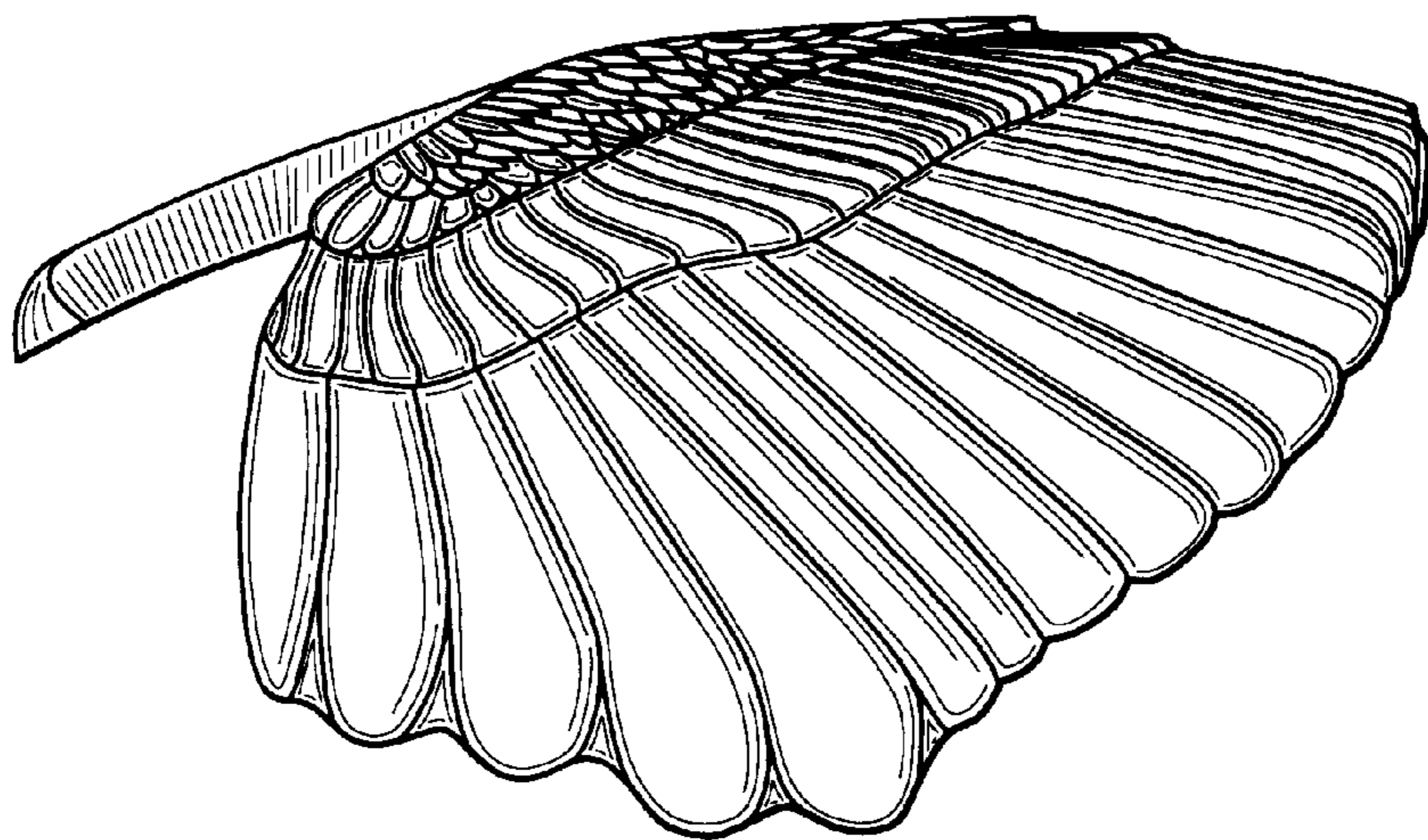

FIG. 6

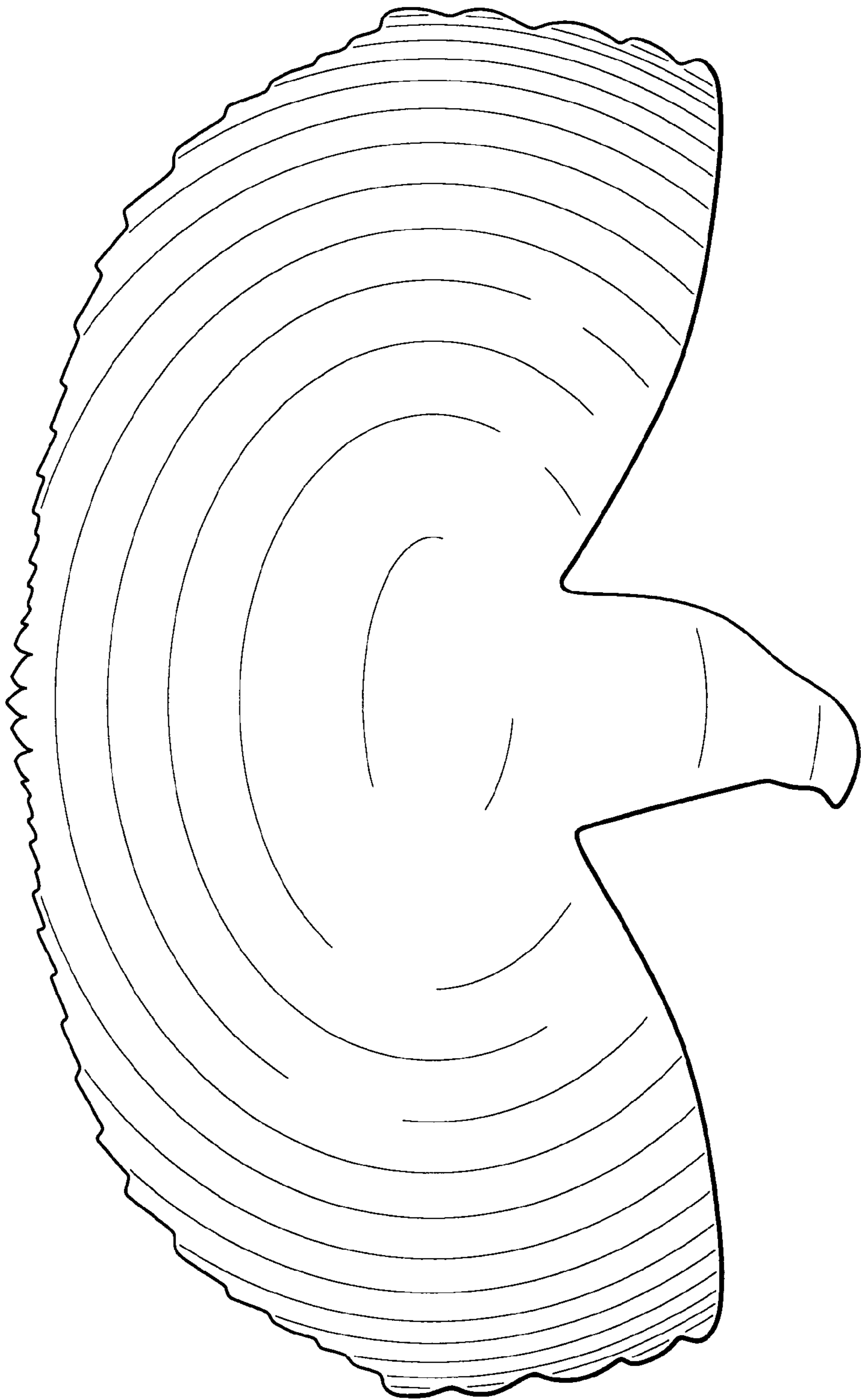

FIG. 7

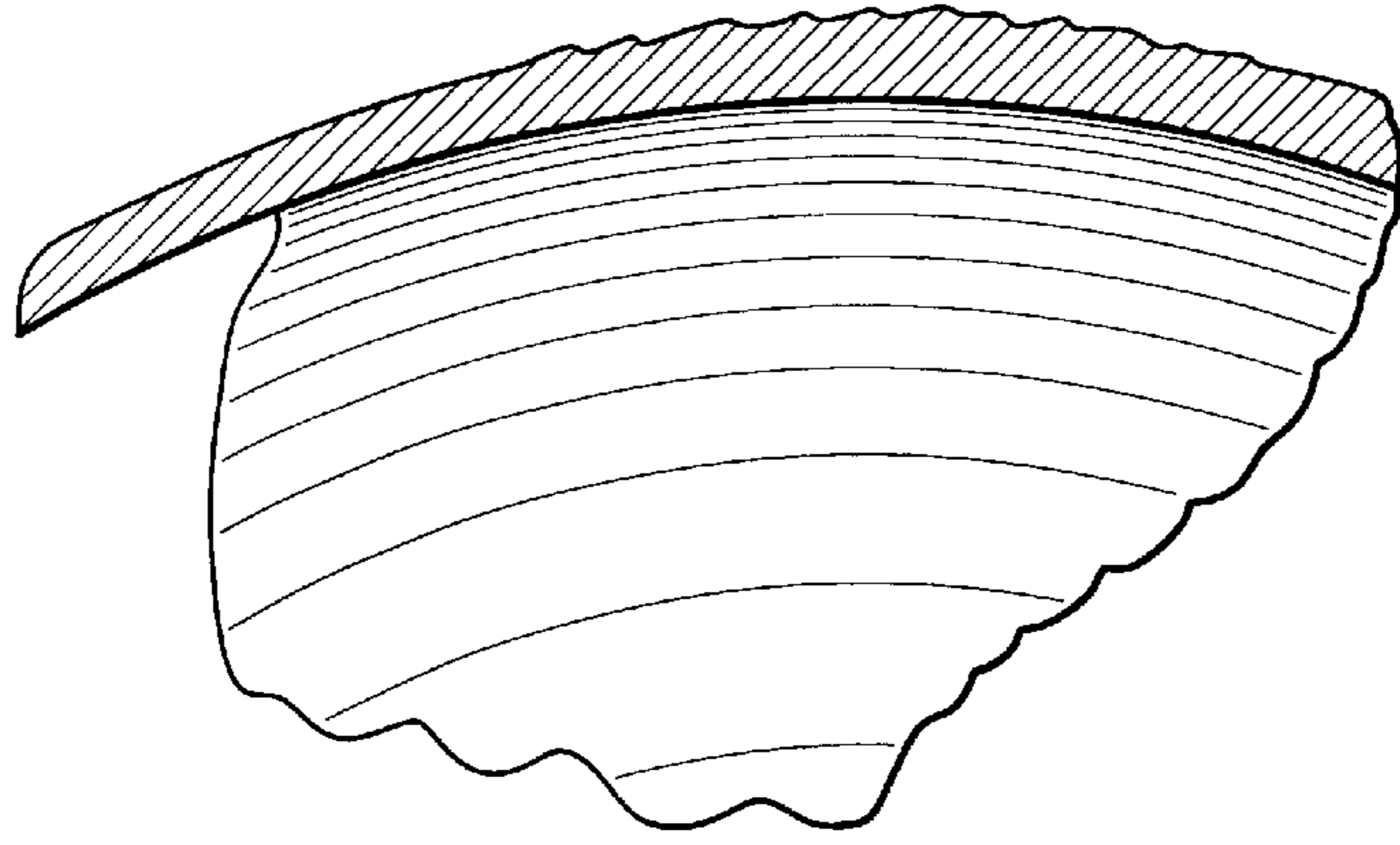

FIG. 8

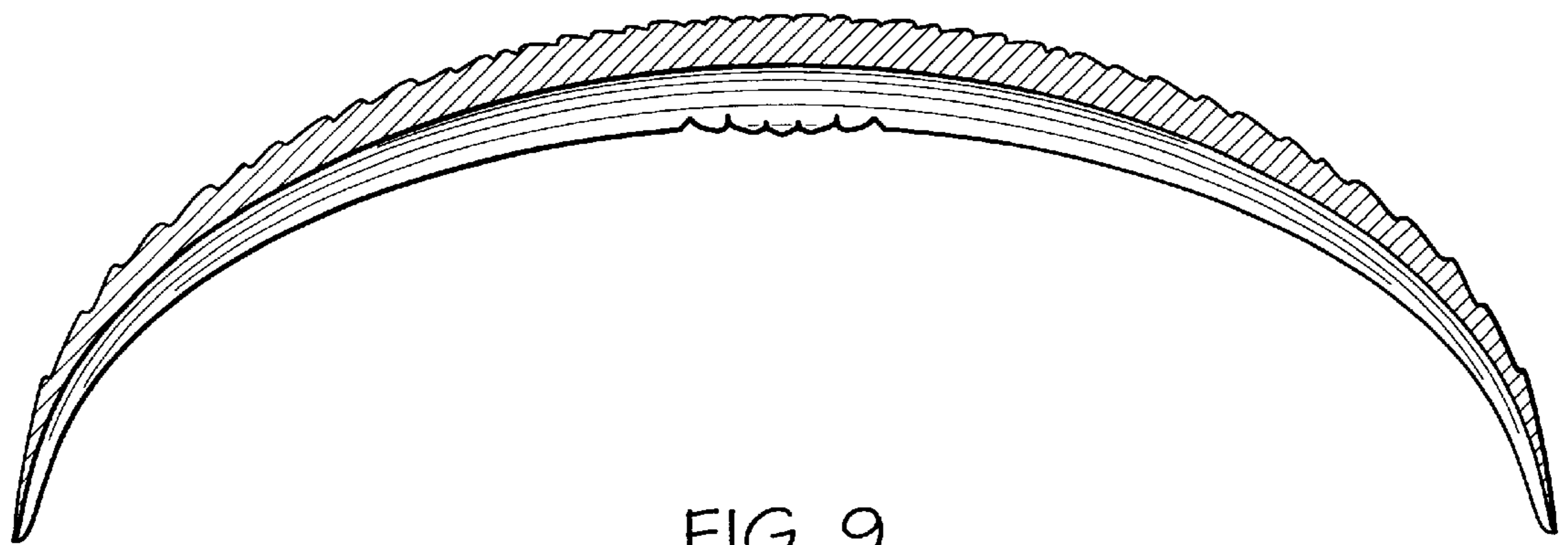

FIG. 9



US00D431211C1

(12) **EX PARTE REEXAMINATION CERTIFICATE** (7649th)
United States Patent
Hoop et al.

(10) **Number:** **US D431,211 C1**
(45) **Certificate Issued:** **Jul. 27, 2010**

- (54) **PAIR OF MOTORCYCLE FAIRING GUARDS**
- (76) Inventors: **Mark R. Hoop**, 693 Carlsbad Rd., Cincinnati, OH (US) 45240; **Lisa J. Hoop**, 693 Carlsbad Rd., Cincinnati, OH (US) 45240

D54,323	S	*	12/1919	Lafferty	D11/107
D129,293	S	*	9/1941	Selle	D11/107
D142,209	S	*	8/1945	Bradbury	D11/107
3,136,513	A	*	6/1964	Selmyhr	211/70.7
D212,252	S	*	9/1968	Appel et al.	D26/98
4,050,231	A	*	9/1977	Lopez et al.	368/273
D272,424	S	*	1/1984	Stahel	D11/107
D428,831	S		8/2000	Hoop et al.	D12/114

Reexamination Request:
No. 90/005,845, Oct. 13, 2000

Reexamination Certificate for:
Patent No.: **Des. 431,211**
Issued: **Sep. 26, 2000**
Appl. No.: **29/120,869**
Filed: **Mar. 28, 2000**

- (**) Term: **14 Years**
 - (51) **LOC (9) Cl.** **12-11**
 - (52) **U.S. Cl.** **D12/126**
 - (58) **Field of Classification Search** D12/114, D12/110, 126, 182, 199; 180/219; 280/288.4, 280/304.3; 296/78.1
- See application file for complete search history.

(56) **References Cited**

U.S. PATENT DOCUMENTS

D19,243	S	*	7/1889	Koster	D5/14
D40,734	S	*	6/1910	Westgard	D11/107
D49,380	S	*	7/1916	Angiulli	D11/107
D53,928	S	*	10/1919	Mergner, Jr.	D11/107

OTHER PUBLICATIONS

Fairing-Mount Flying Eagle Emblem on p. 5 of JCWhitney Motorcycle Accessories & Parts Cat. No. 85J—1999.*
 Harley Owners Group emblem on p. 37 of Harley Davidson Motorclothes Collectibles—Spring 1995.*
 Eagle Fairing Decals H on p. 121 of 1996 Harley Davidson Genuine Motor Accessories & Parts.*
 Various eagle images on p. 45 of Harley Davidson Motorclothes Collectibles—Spring 1995.*
 Eagle image on a cigarette lighter on p. 63 of Harley Davidson Motorclothes Collectibles—Spring 1995.*
 Eagle images for close hook designs on p. 68 of Harley Davidson Motorclothes Collectibles—Spring 1995.*
 Eagle image on Fat Boy Fender Trim—1996 Harley Davidson Genuine Motor Accessories & Parts.*
 Eagle images in military medal designs on p. 151 of Sweetheart Jewelry and Collectables (c) 1995.*
 Various eagle images on p. 37 of Harley Davidson Motorclothes Spring 1995 Supplement.*

* cited by examiner

Primary Examiner—Adir Aronovich

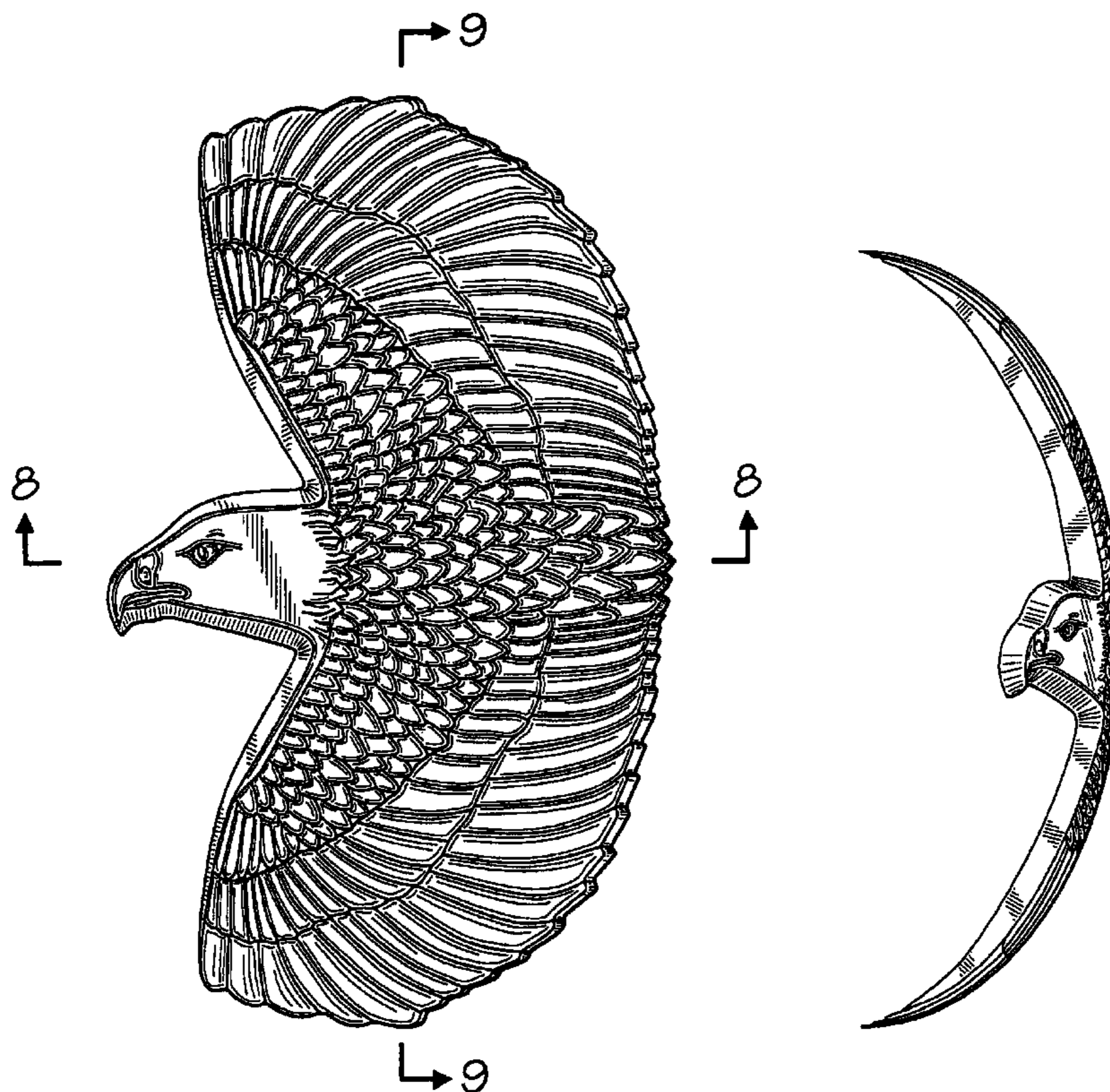

**EX PARTE
REEXAMINATION CERTIFICATE
ISSUED UNDER 35 U.S.C. 307**

AS A RESULT OF REEXAMINATION, IT HAS BEEN
DETERMINED THAT:

Claim 1 is cancelled.