



US00D431197S

United States Patent [19]
Pau

[11] **Patent Number: Des. 431,197**
[45] **Date of Patent: ** Sep. 26, 2000**

[54] **KITCHEN TIMER** 4,194,354 3/1980 Terrailon 368/276

[75] Inventor: **Kit Kwun Pau**, Kowloon, The Hong Kong Special Administrative Region of the People's Republic of China

[73] Assignee: **Wings Product Workshop Limited**, The Hong Kong Special Administrative Region of the People's Republic of China

[**] Term: **14 Years**

[21] Appl. No.: **29/117,618**

[22] Filed: **Jan. 24, 2000**

[51] **LOC (7) Cl.** **10-03**

[52] **U.S. Cl.** **D10/40**

[58] **Field of Search** D10/1-40, 122-132;
368/96-100, 107-121, 276-277, 285, 316,
317

[56] **References Cited**

U.S. PATENT DOCUMENTS

D. 236,697	9/1975	Draghi	D10/40
D. 278,801	5/1985	Long	D10/40
D. 284,227	6/1986	Dagowitz et al.	D99/37
D. 394,013	5/1998	Morelli et al.	D10/40

OTHER PUBLICATIONS

Hong Kong Enterprise—Oct. 1995—p.204—rabbit timers on top row.

Primary Examiner—Nelson C. Holtje
Attorney, Agent, or Firm—Alix, Yale & Ristas, LLP

[57] **CLAIM**

The ornamental design for a kitchen timer, as shown and described.

DESCRIPTION

FIG. 1 is a front perspective view of the kitchen timer showing my new design;
FIG. 2 is a front view of the kitchen timer of FIG. 1;
FIG. 3 is a left side view of the kitchen timer of FIG. 1;
FIG. 4 is a top plan view of the kitchen timer of FIG. 1;
FIG. 5 is a rear view of the kitchen timer of FIG. 1;
FIG. 6 is a right side view of the kitchen timer of FIG. 1;
FIG. 7 is a bottom plan view of the kitchen of FIG. 1; and,
FIG. 8 is a front perspective view of a second embodiment of my new design of FIGS. 1-7, wherein the other views thereof are consistent with FIGS. 2-7 but with numerals thereon.

1 Claim, 4 Drawing Sheets

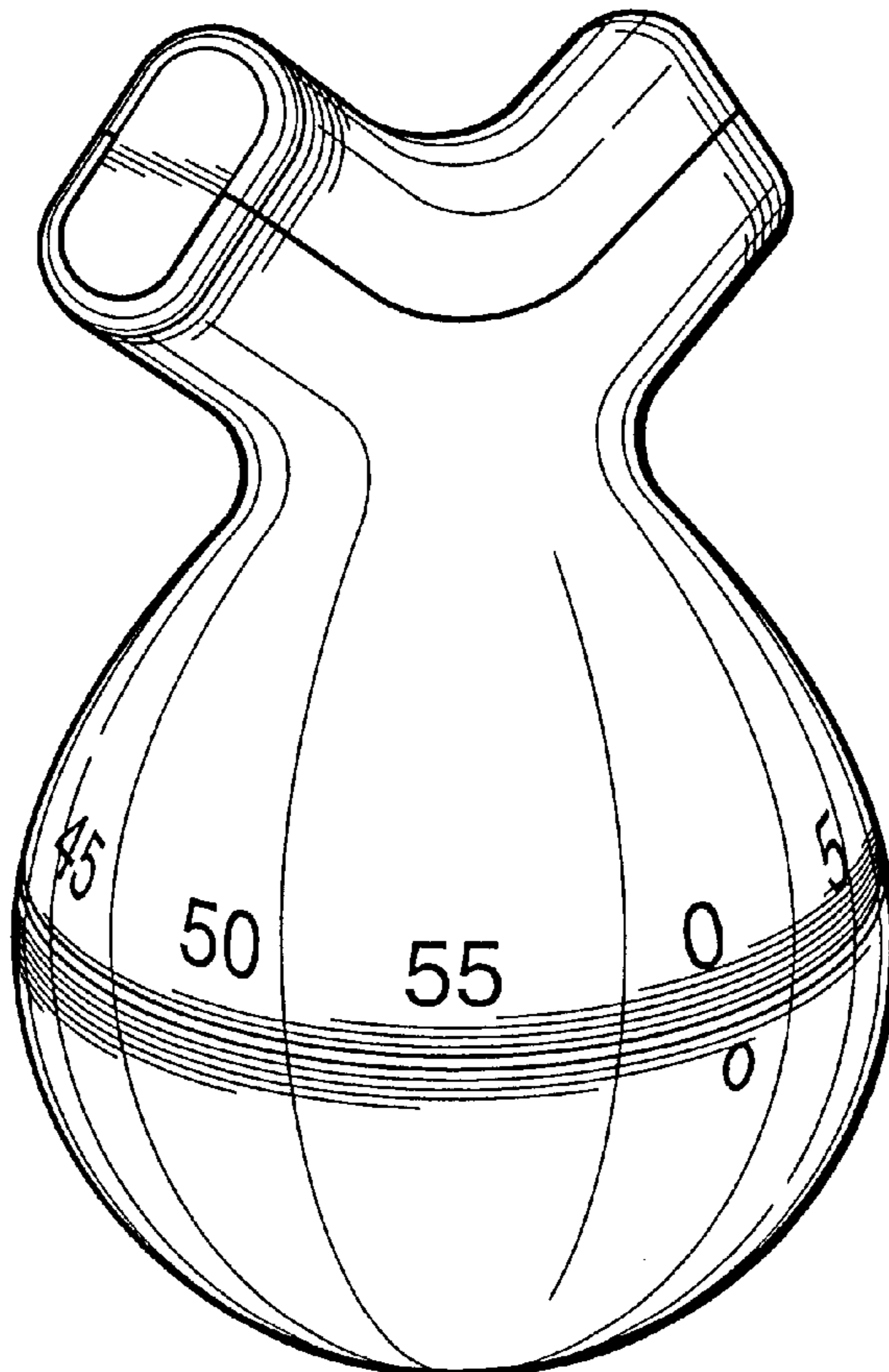

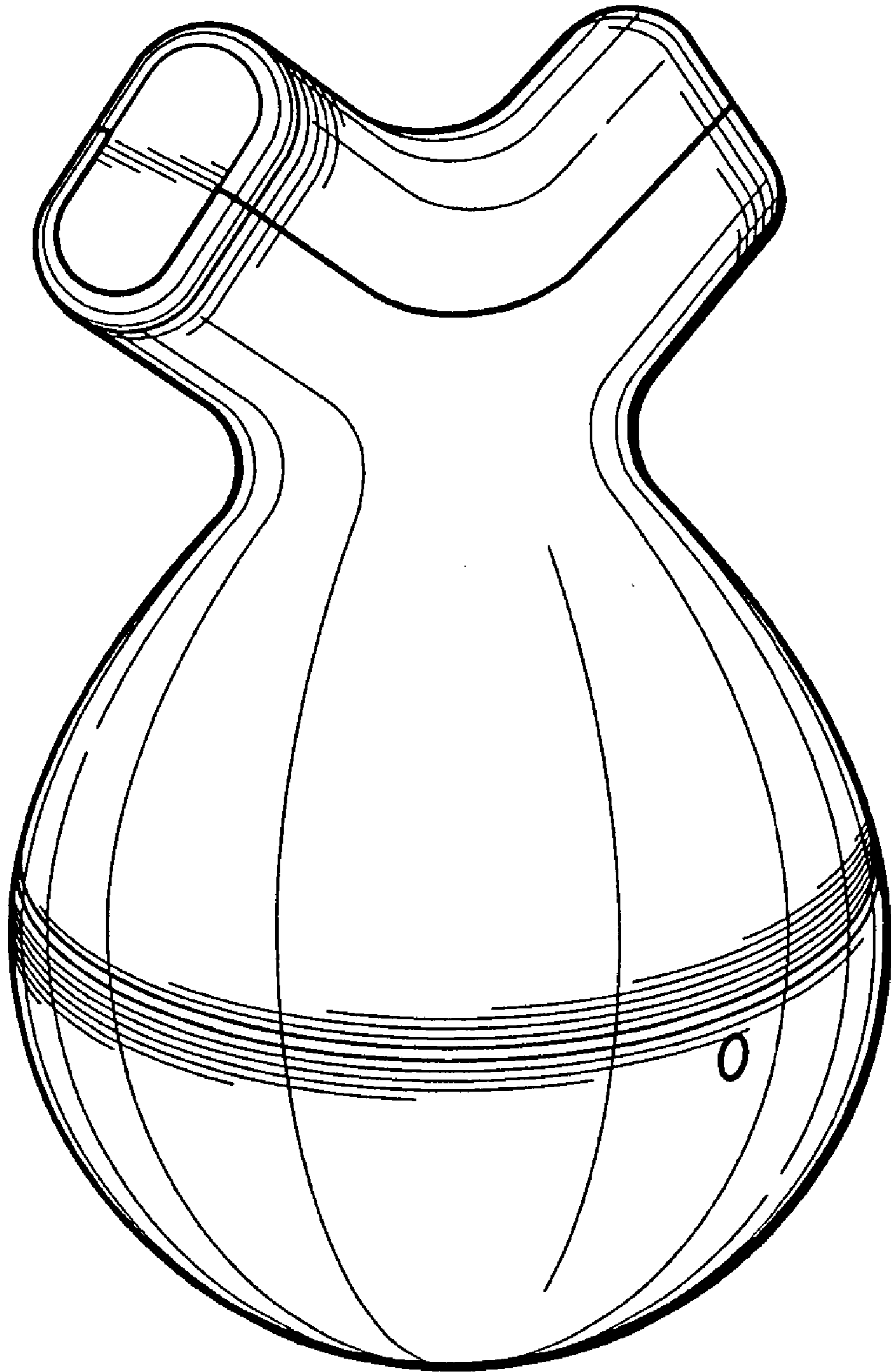

FIG. 1

FIG. 4

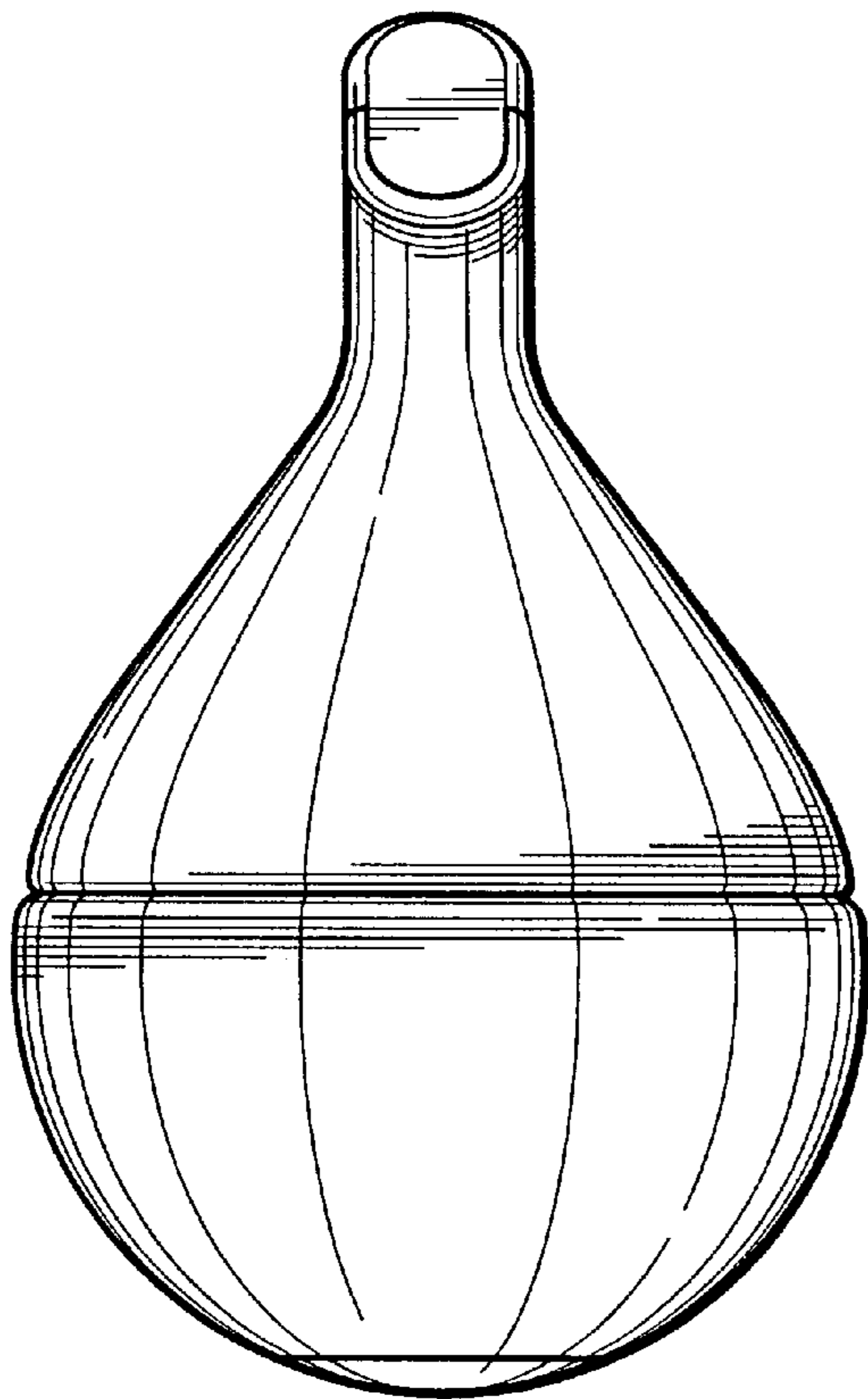
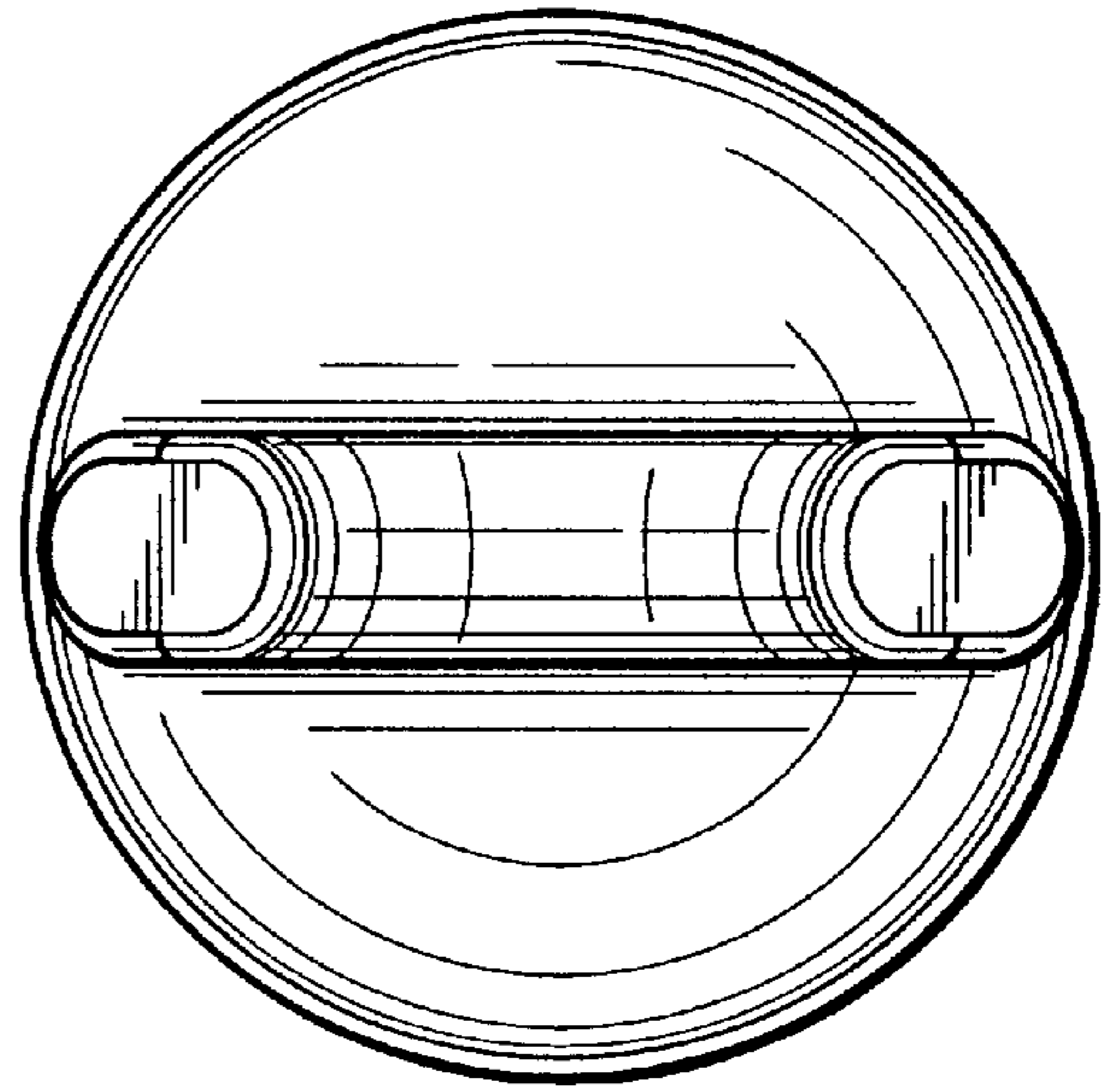

FIG. 3

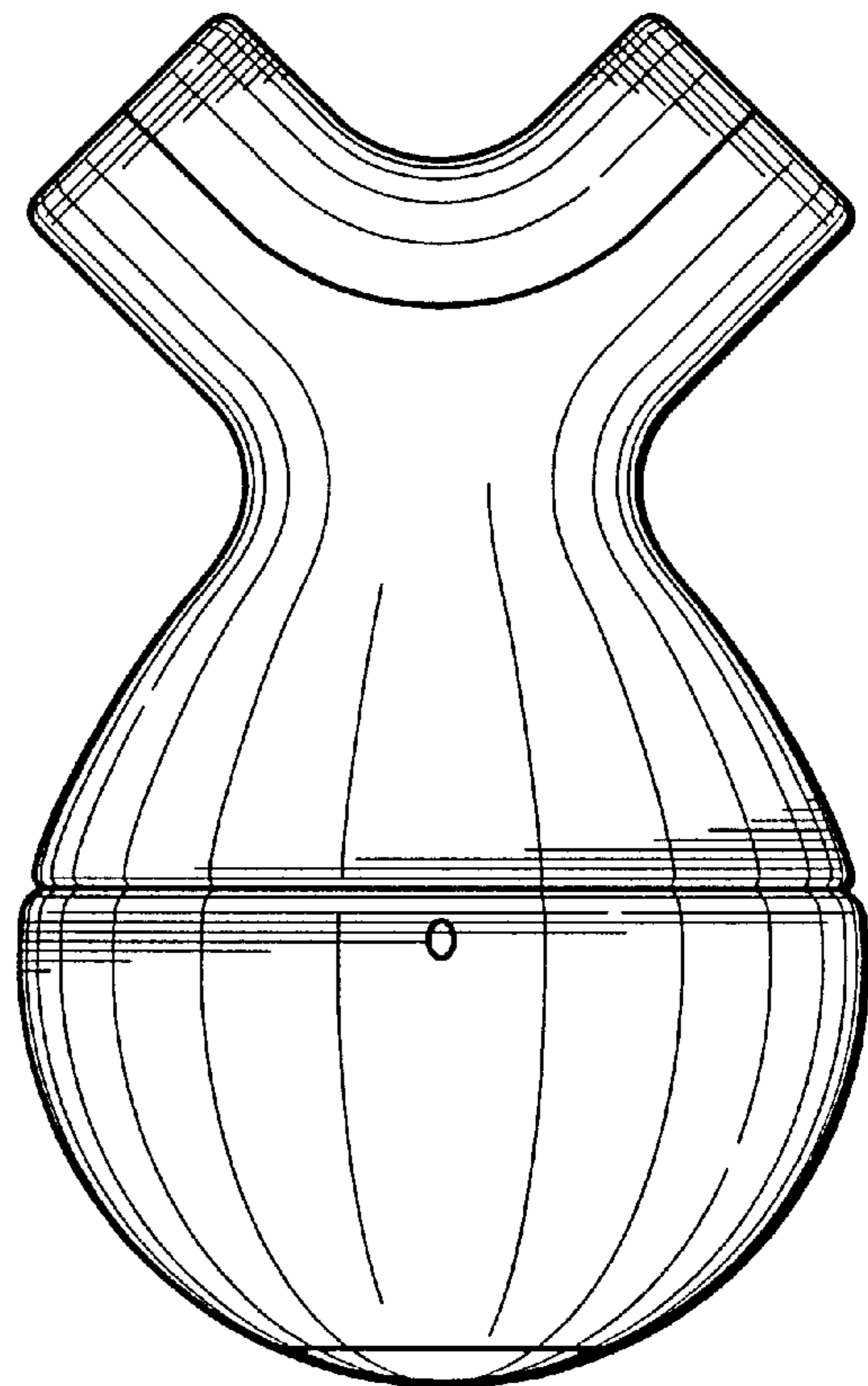

FIG. 2

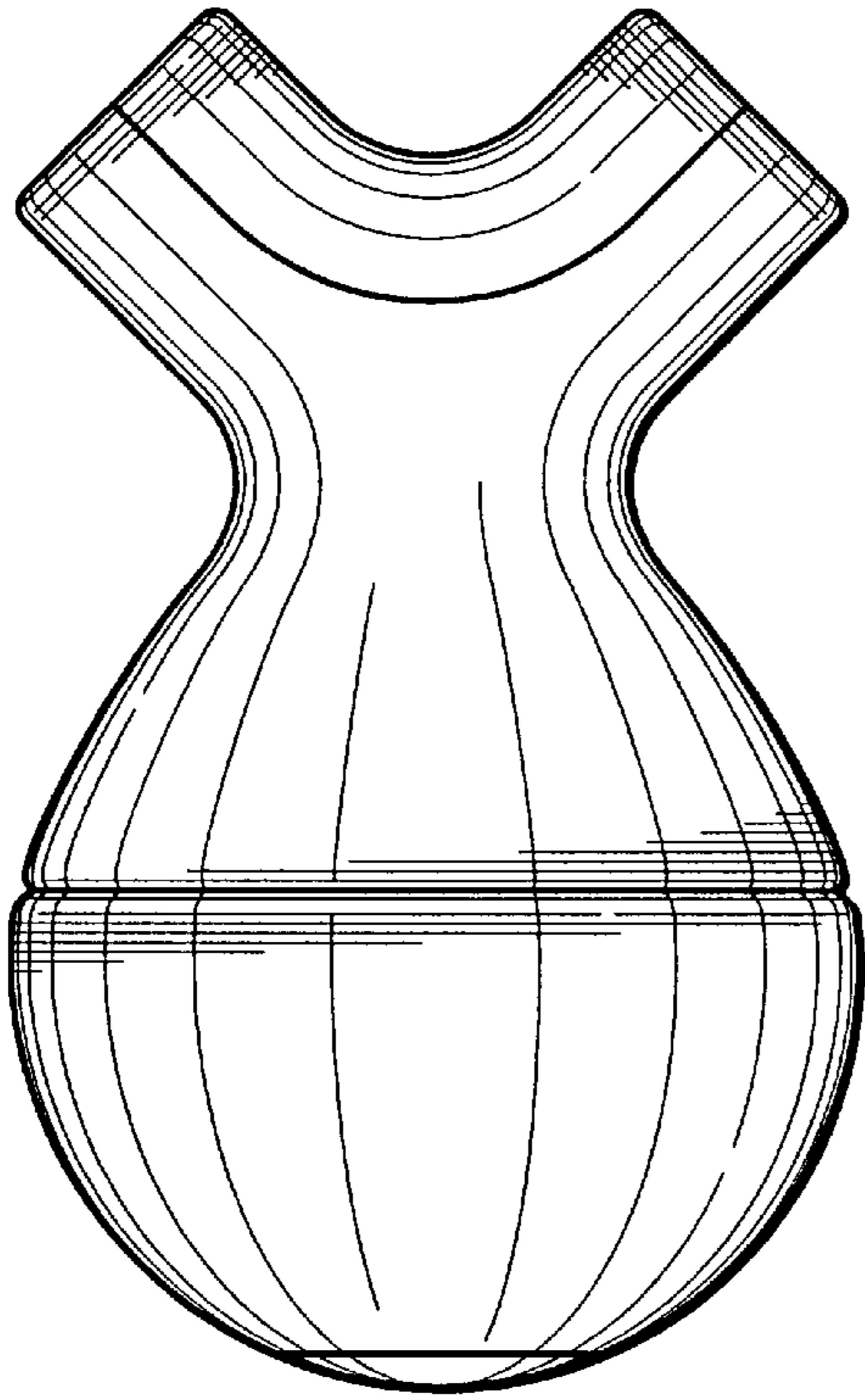

FIG. 5

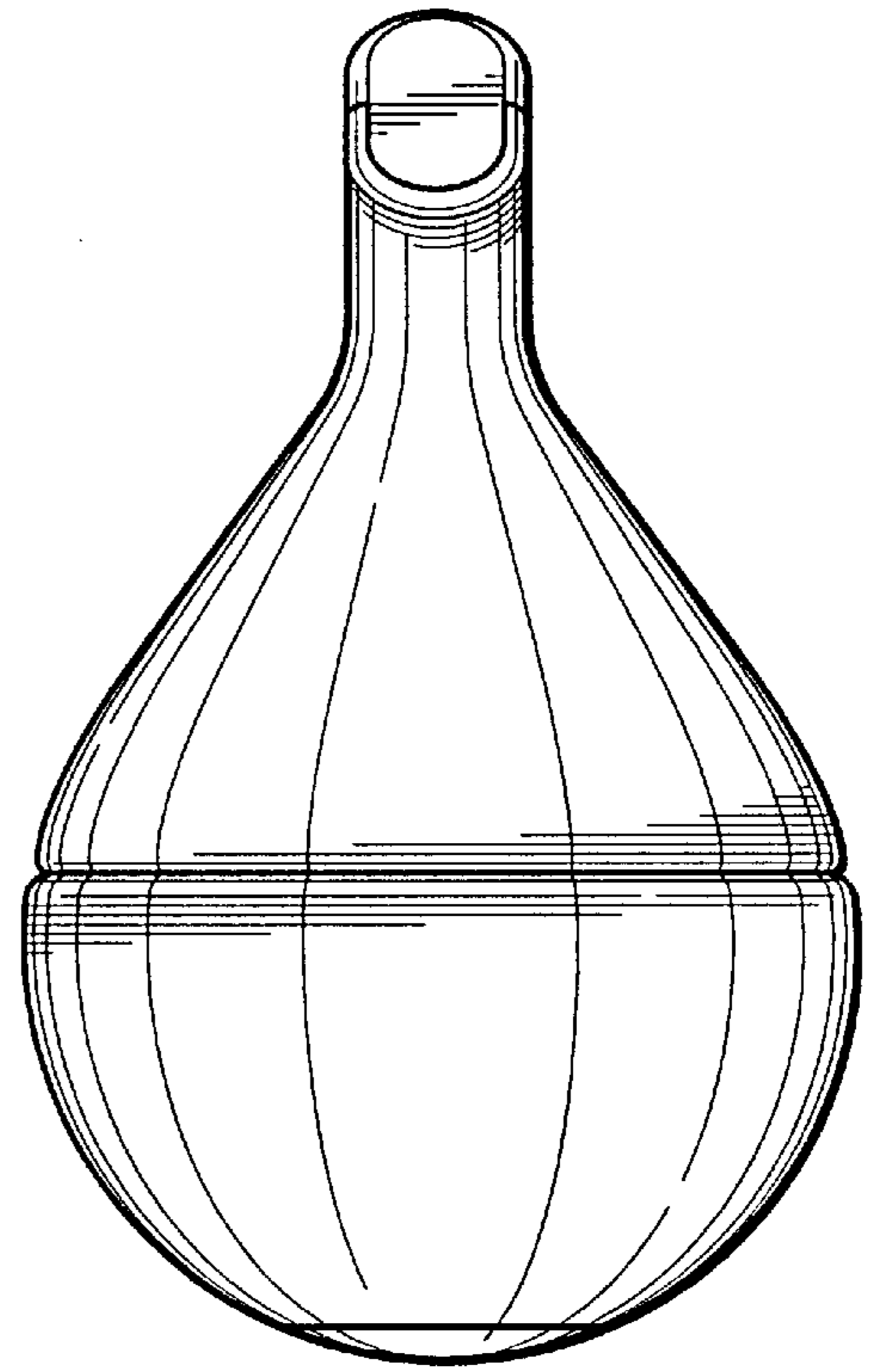

FIG. 6

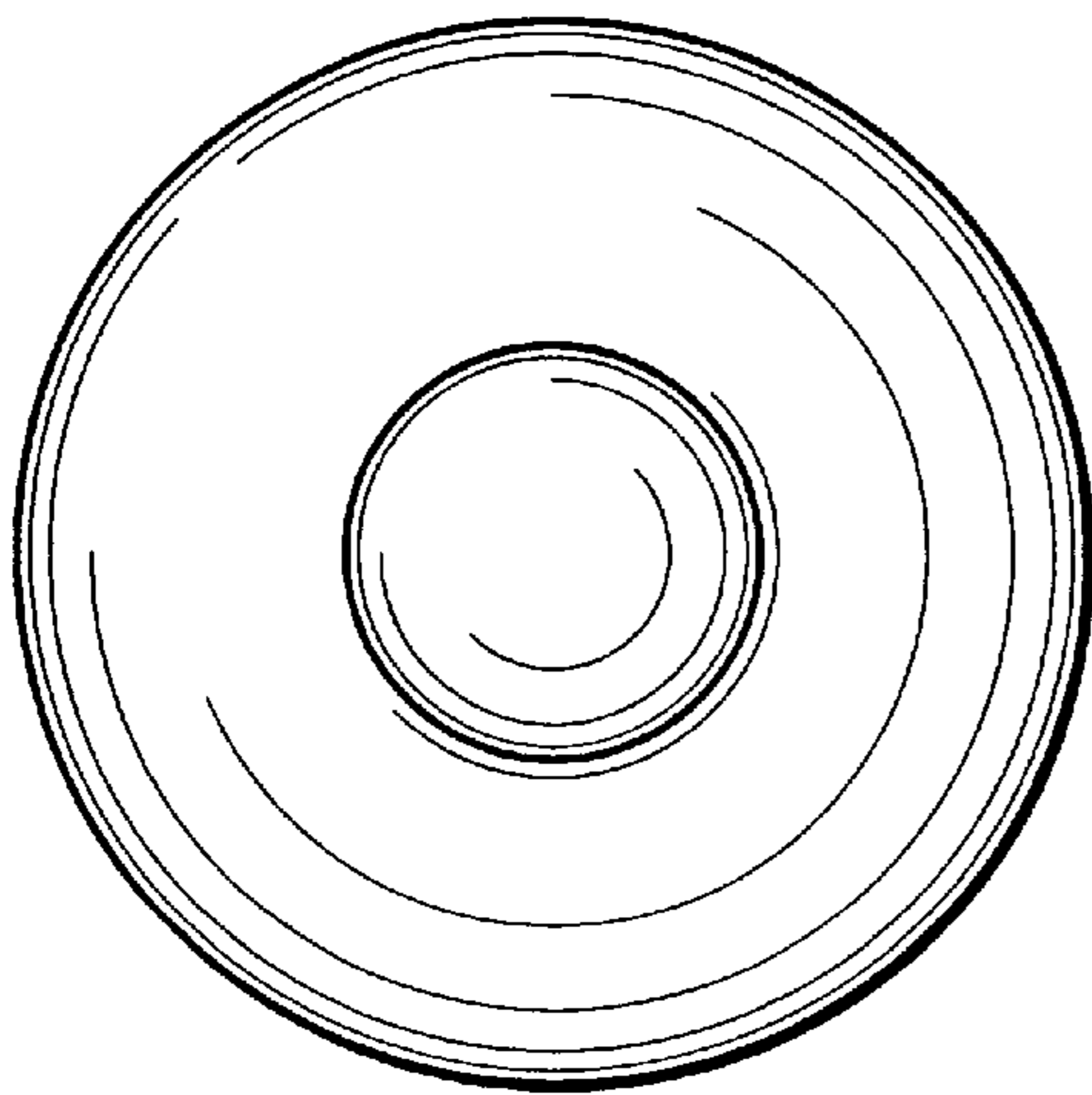

FIG. 7

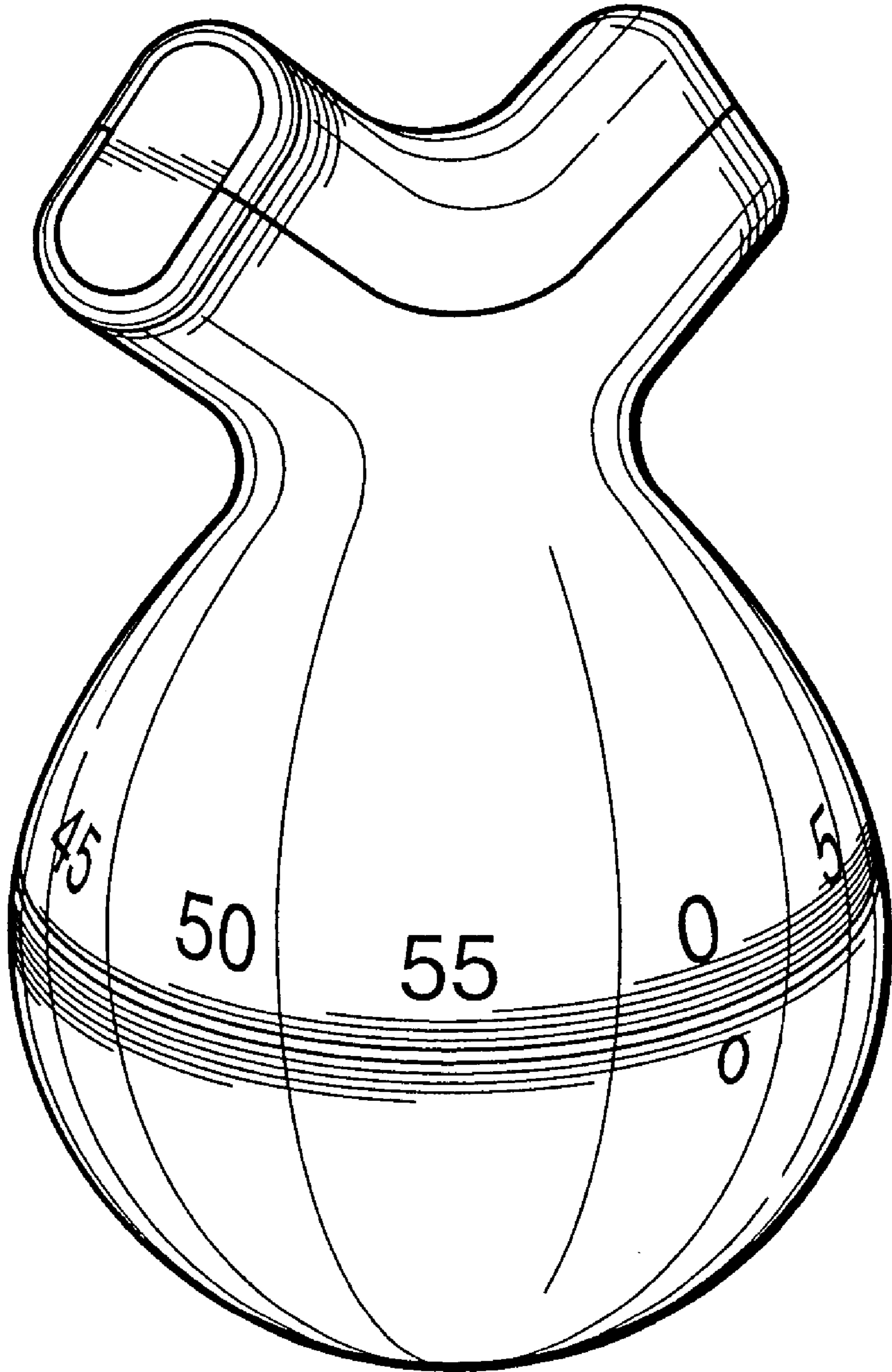

FIG. 8