



US00D431130S

United States Patent [19]

[11] **Patent Number: Des. 431,130**

Thompson et al.

[45] **Date of Patent: ** Sep. 26, 2000**

[54] **CABINET**

Attorney, Agent, or Firm—Rader, Fishman, Grauer & McGarry an office of Rader, Fishman & Grauer PLLC

[75] Inventors: **James J. Thompson; Adam A. Luedke**, both of Holland, Mich.

[57] **CLAIM**

[73] Assignee: **Trendway Corporation**, Holland, Mich.

The ornamental design for a cabinet, as shown and described.

[**] Term: **14 Years**

DESCRIPTION

[21] Appl. No.: **29/101,414**

FIG. 1 is a perspective view of a cabinet showing our new design;

[22] Filed: **Mar. 3, 1999**

FIG. 2 is a front elevational view thereof;

[51] **LOC (7) Cl. 06-04**

FIG. 3 is a rear elevational view thereof;

[52] **U.S. Cl. D6/445**

FIG. 4 is a right side elevational view thereof, of which the left side elevational view is a mirror image thereof;

[58] **Field of Search D6/432-448; 312/204, 312/257**

FIG. 5 is a top plan view thereof;

FIG. 6 is a perspective view of a second embodiment of cabinet shown in FIG. 1;

[56] **References Cited**

FIG. 7 is a front elevational view thereof;

U.S. PATENT DOCUMENTS

D. 240,684	7/1976	Zagaroll	D6/445
D. 330,814	11/1992	Reuschel	D6/446 X
D. 339,252	9/1993	Martinez, Sr.	D6/445
D. 378,030	2/1997	Palka	D6/445
D. 391,785	3/1998	Zaidman et al.	D6/445
D. 410,156	5/1999	Cohen	D6/446
D. 411,060	6/1999	Horn	D6/445
D. 418,329	1/2000	Voight, Jr.	D6/445

FIG. 8 is a rear elevational view thereof;

FIG. 9 is a right side elevational view, the left side being a mirror image thereof,

FIG. 10 is a top plan view thereof,

FIG. 11 is a perspective view of a third embodiment of the cabinet shown in FIG. 1;

FIG. 12 is a front elevational view thereof,

FIG. 13 is a rear elevational view thereof;

FIG. 14 is a right side elevational view, the left side being a mirror image thereof; and,

FIG. 15 is a top plan view thereof.

Primary Examiner—Cathron B. Matta

1 Claim, 8 Drawing Sheets

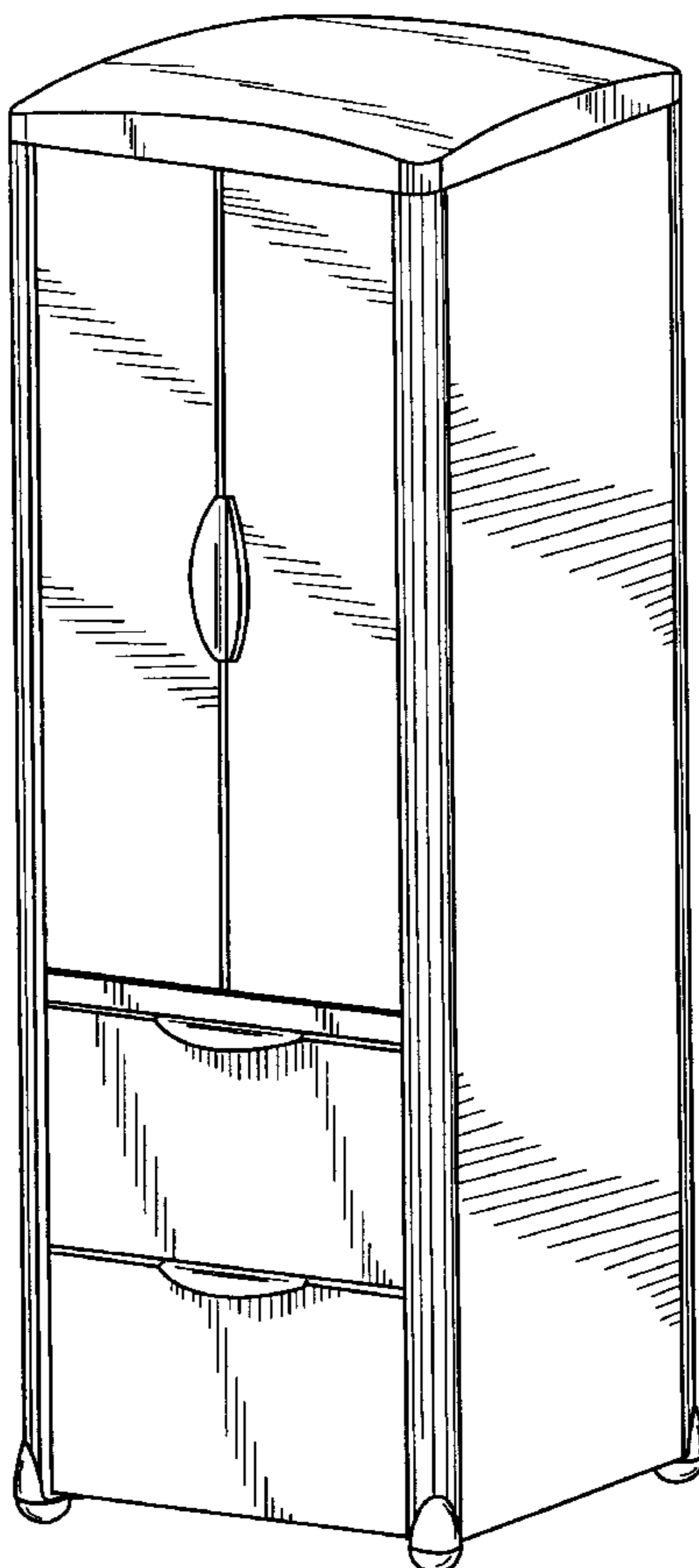

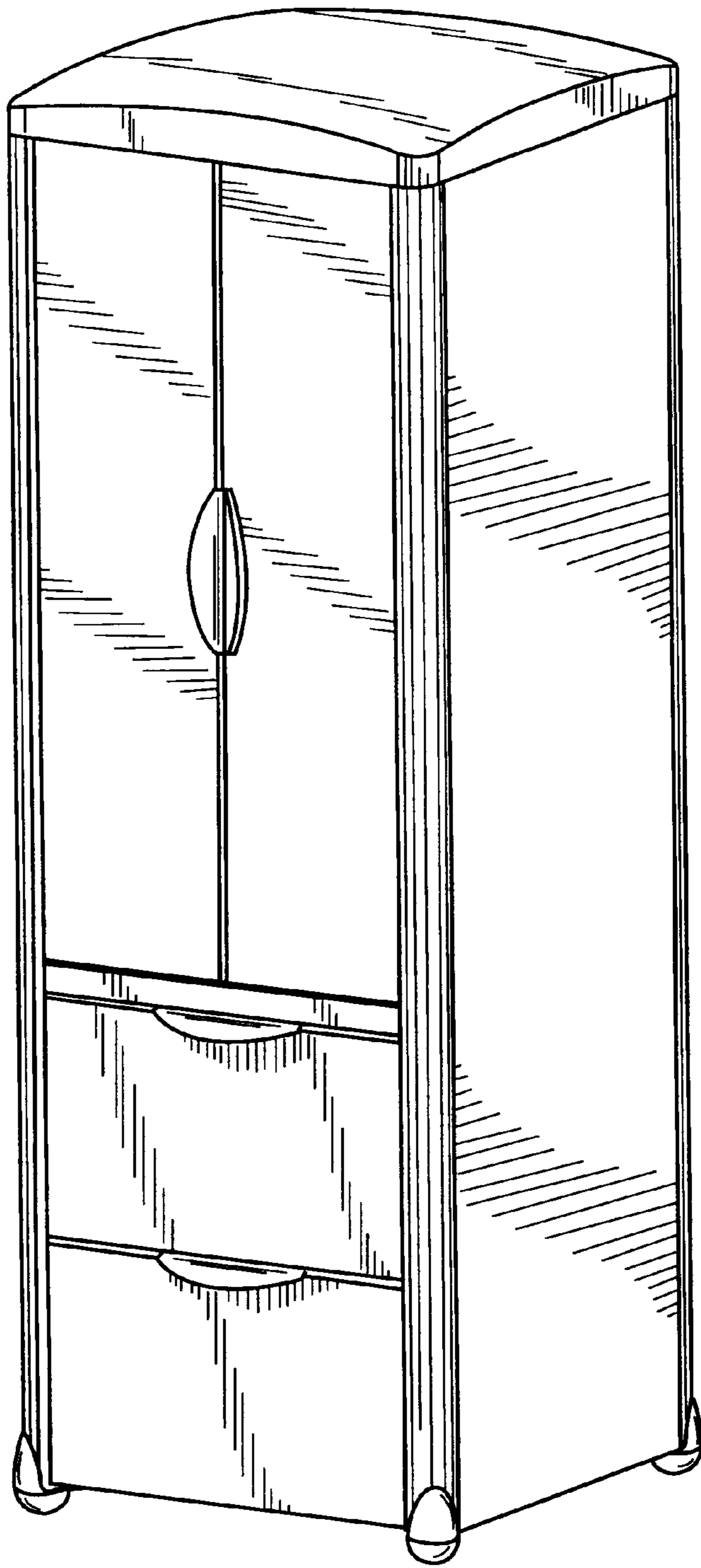

Fig. 1

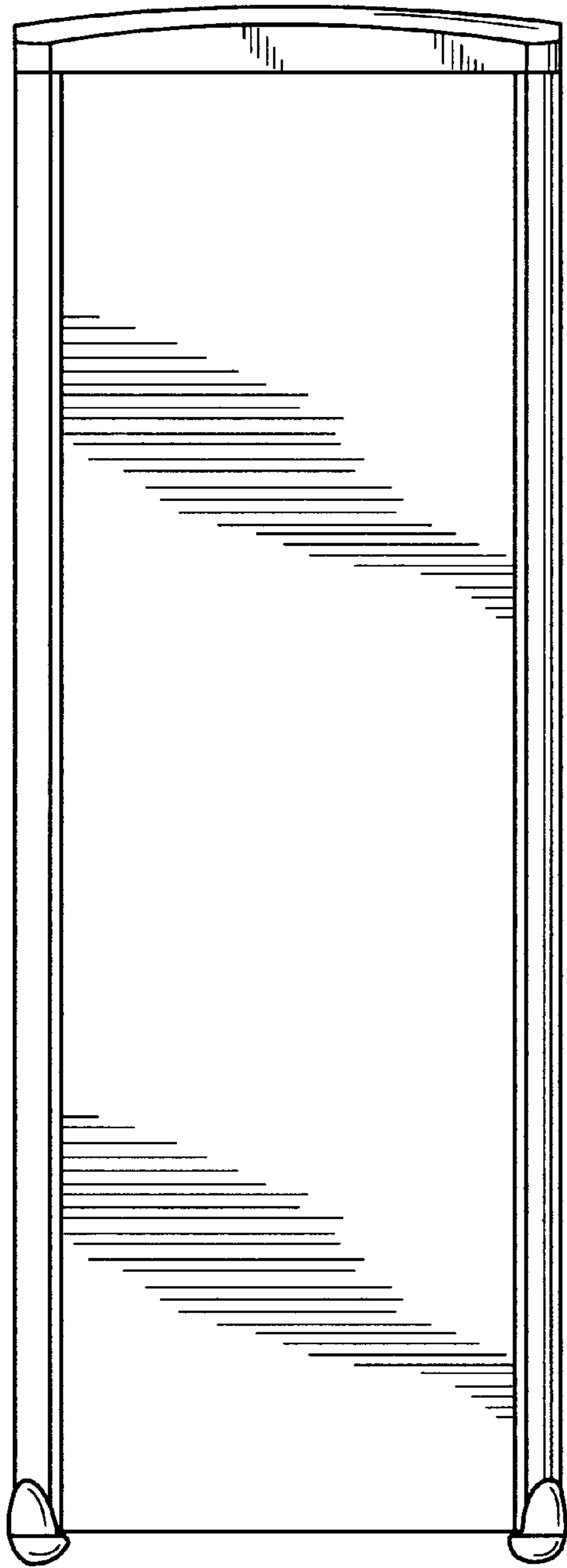

Fig. 3

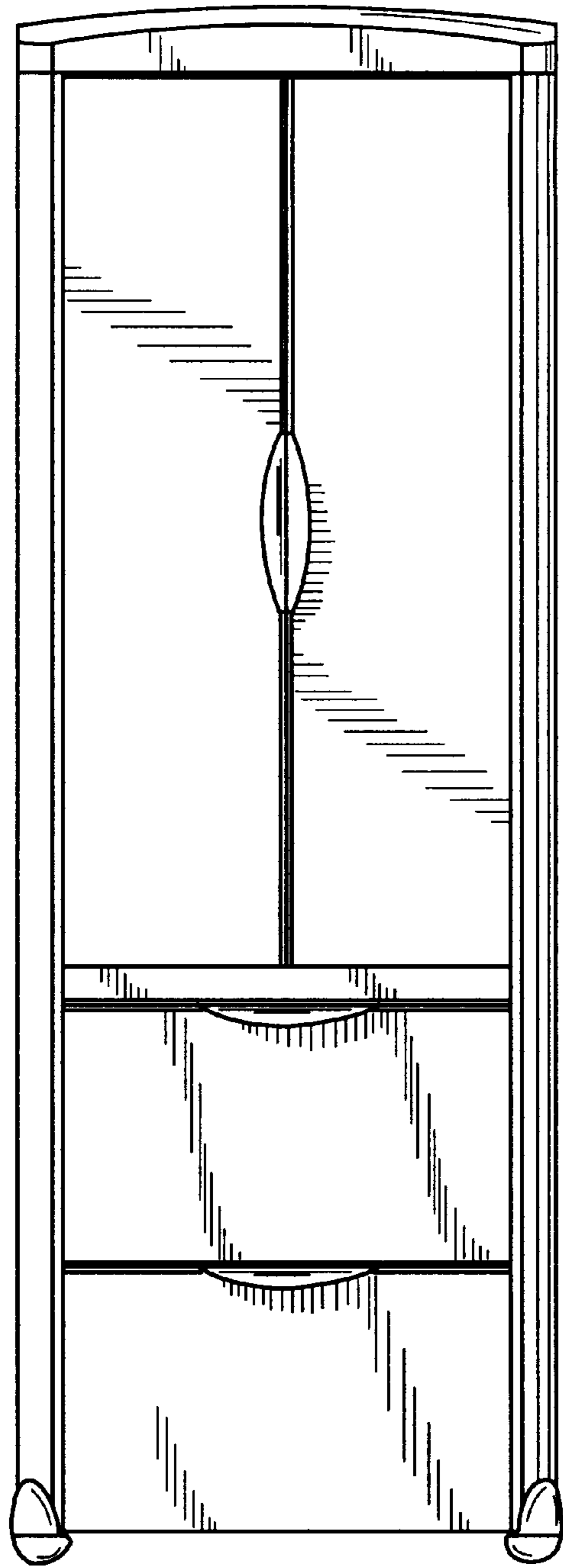

Fig. 2

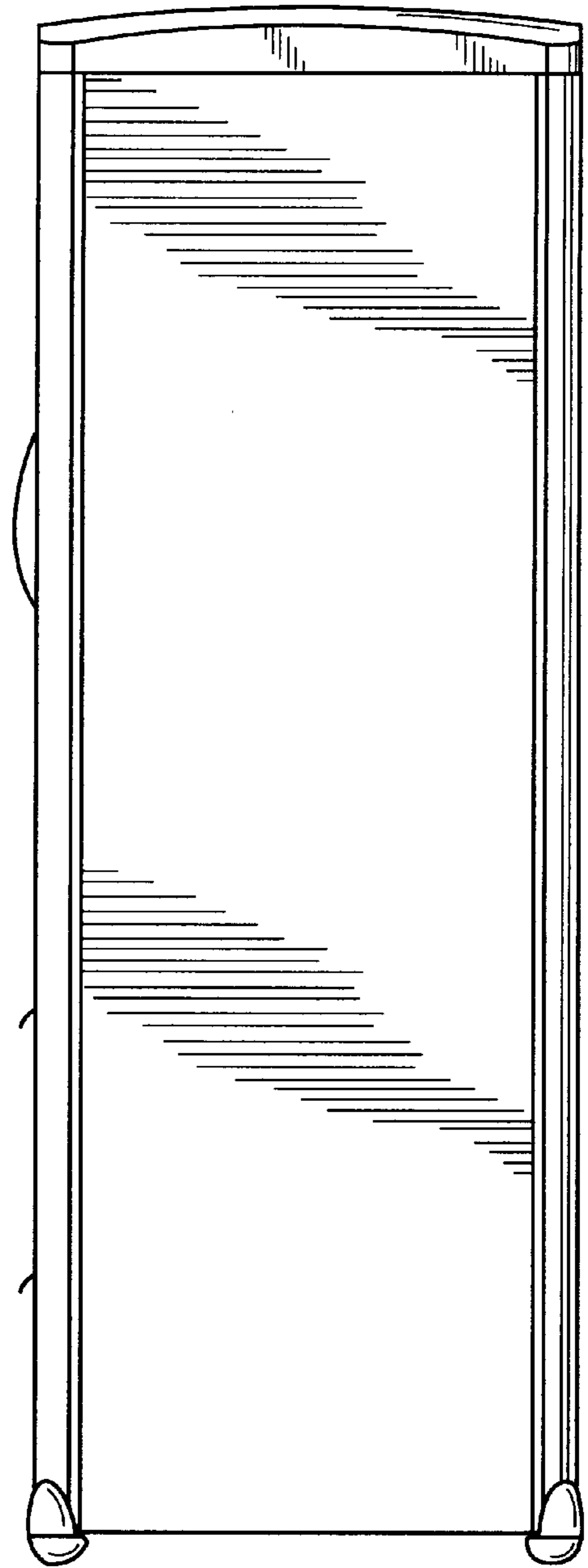

Fig. 4

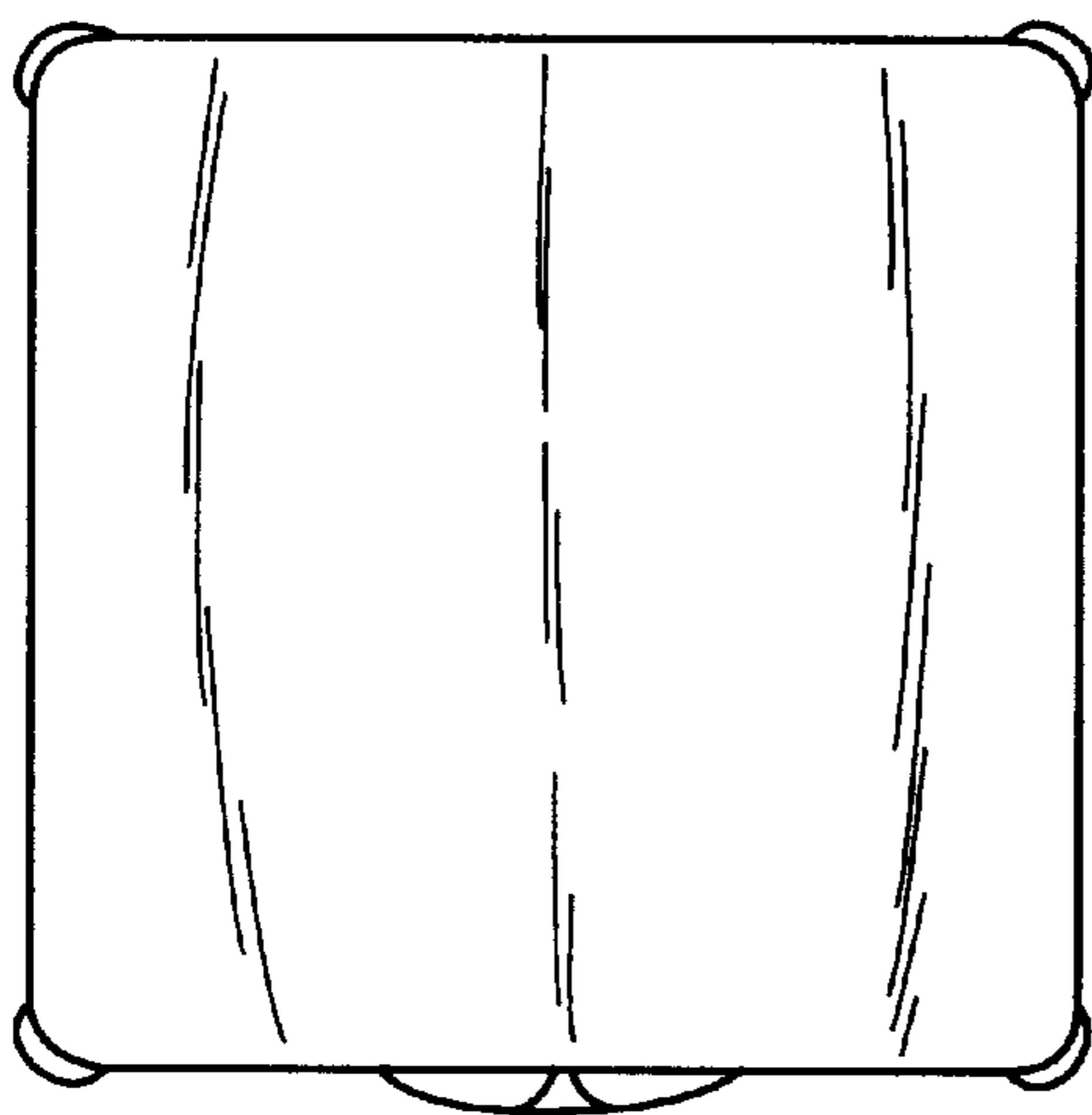

Fig. 5

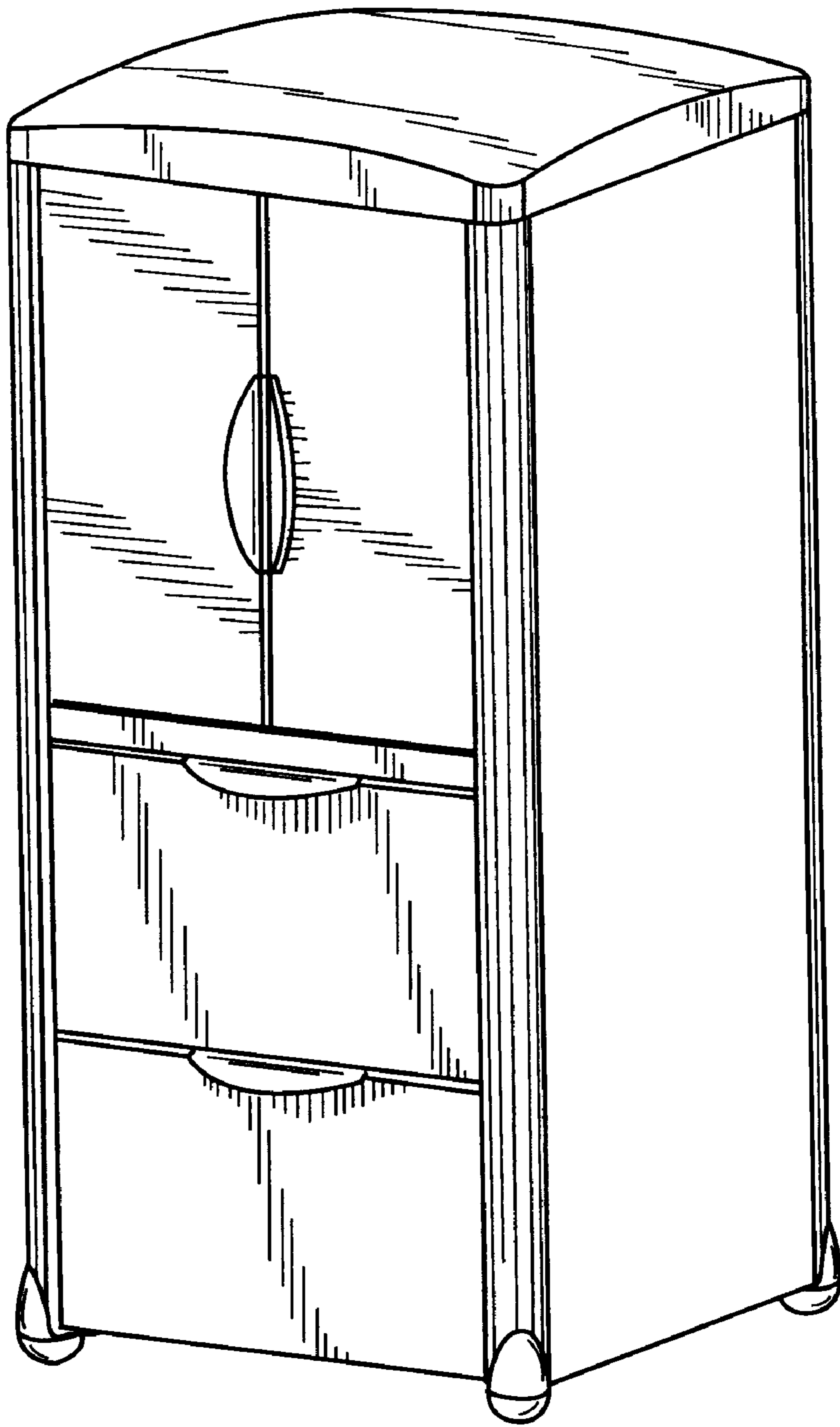

Fig. 6

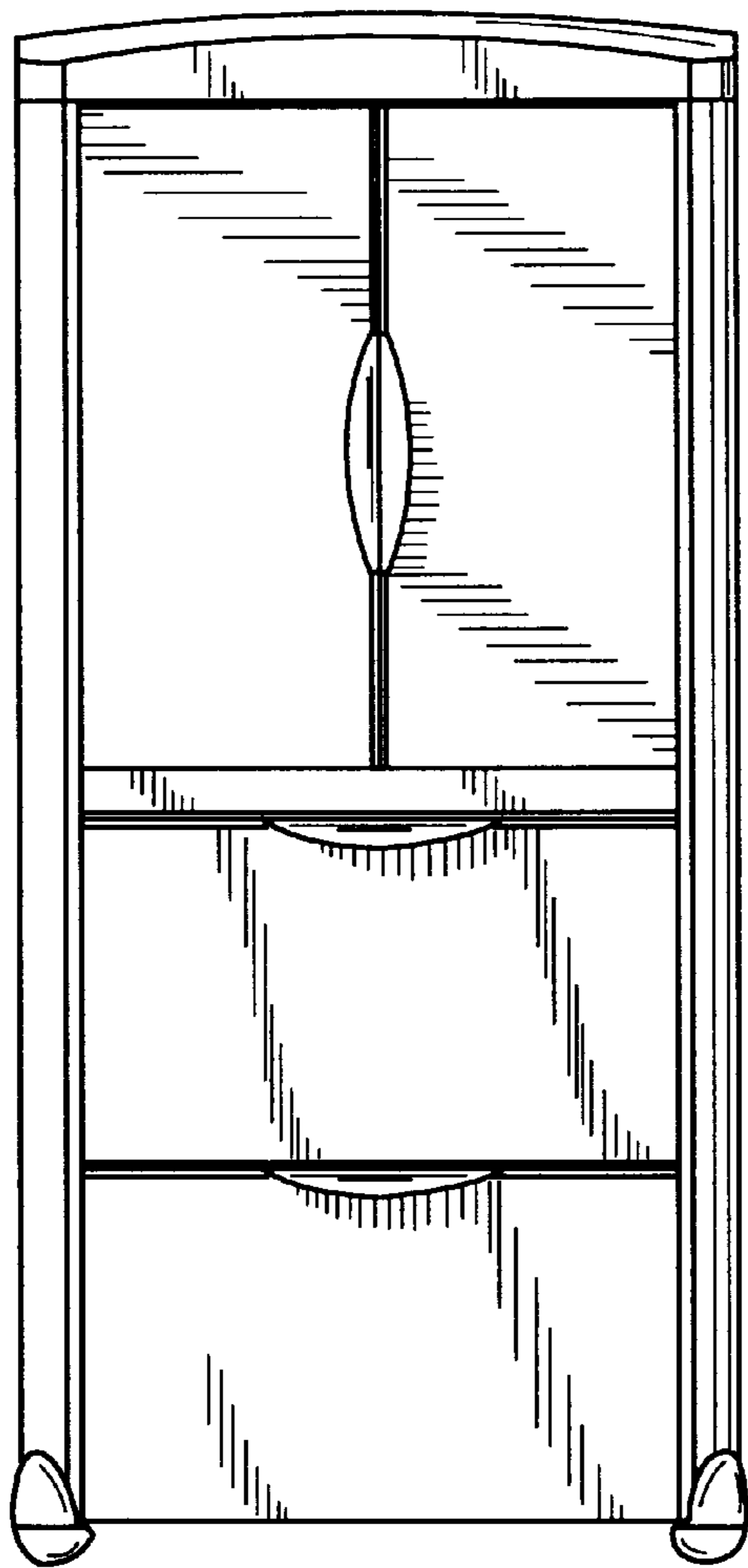

Fig. 7

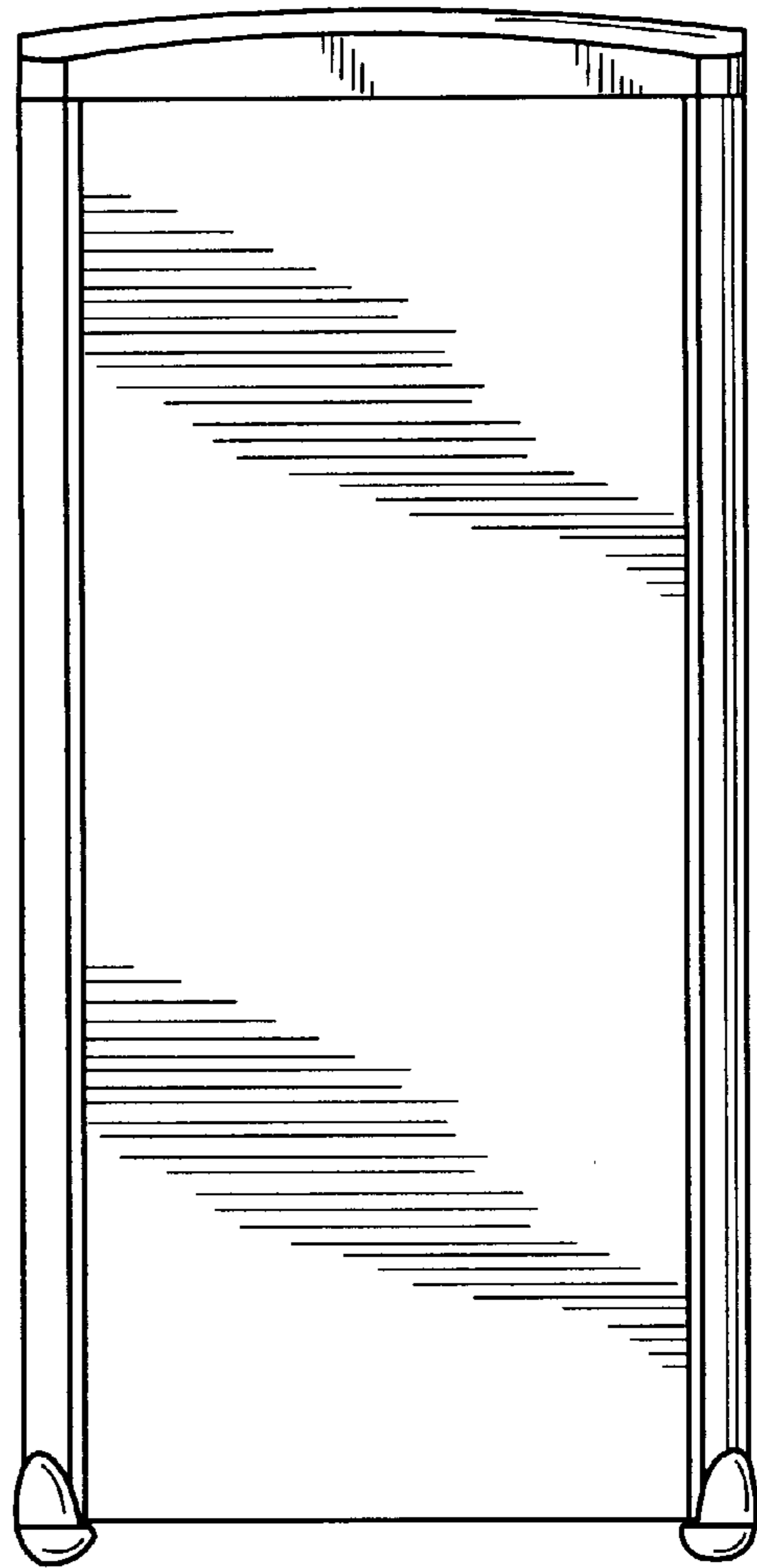

Fig. 8

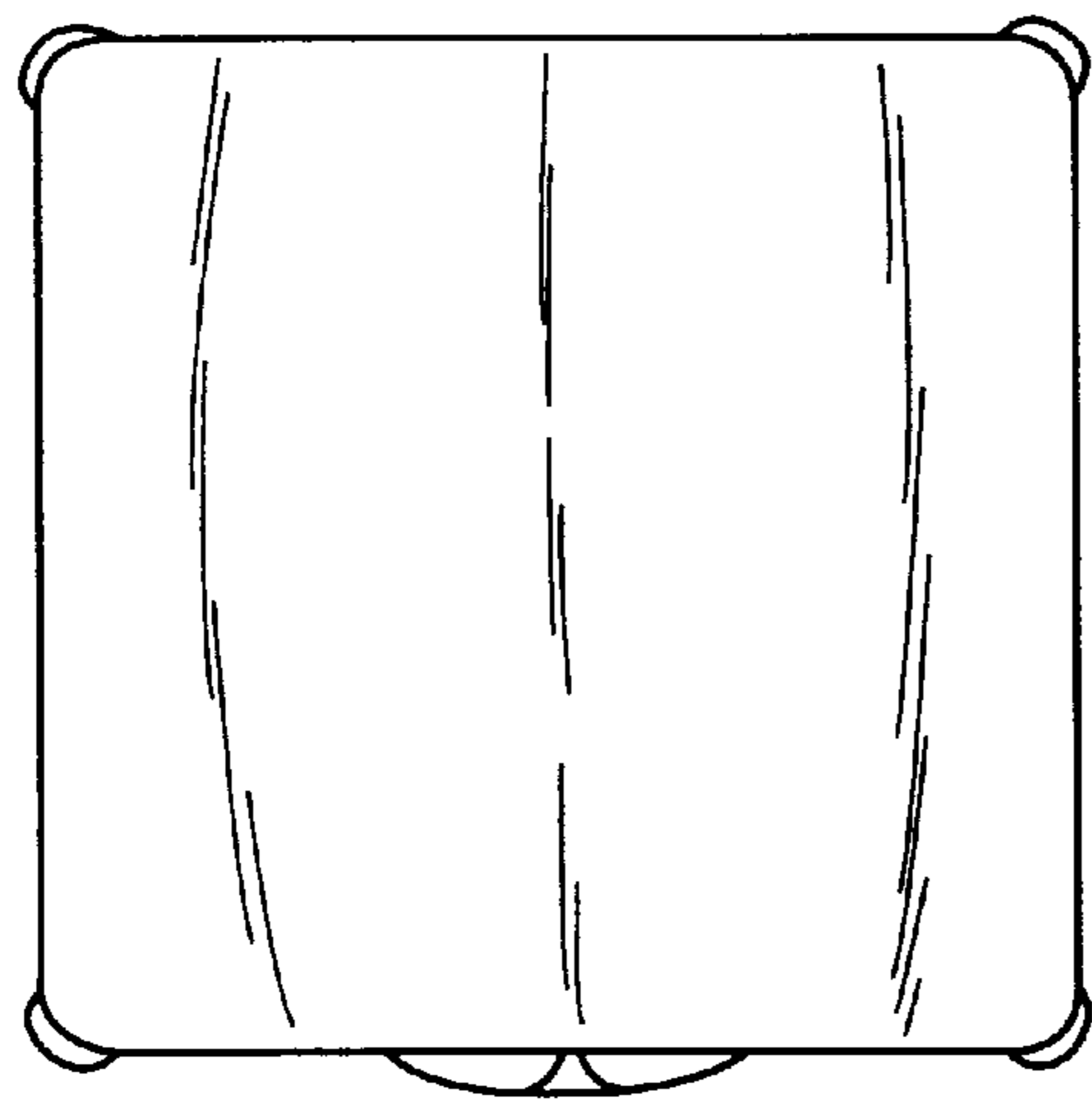

Fig. 9

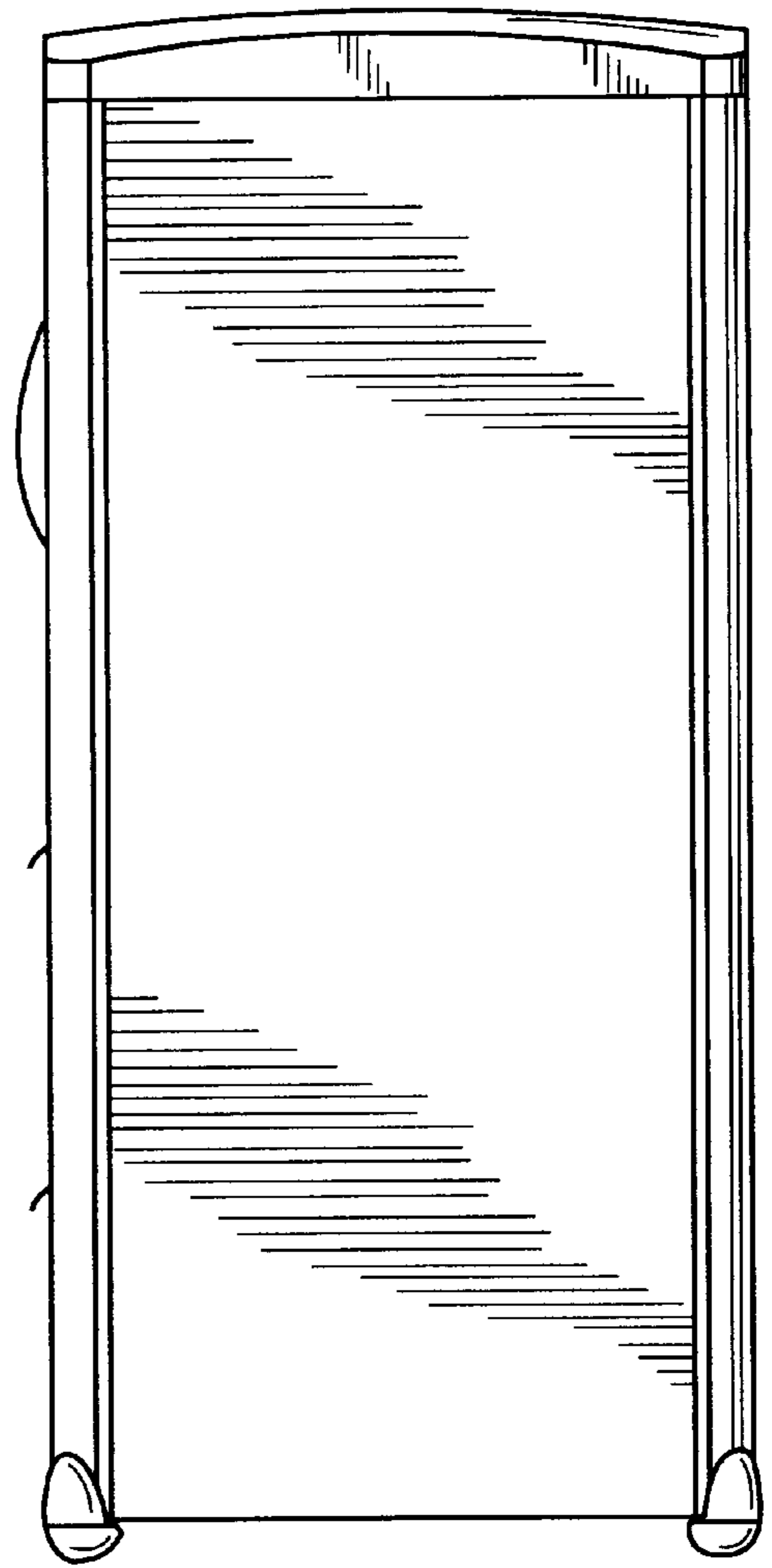

Fig. 10

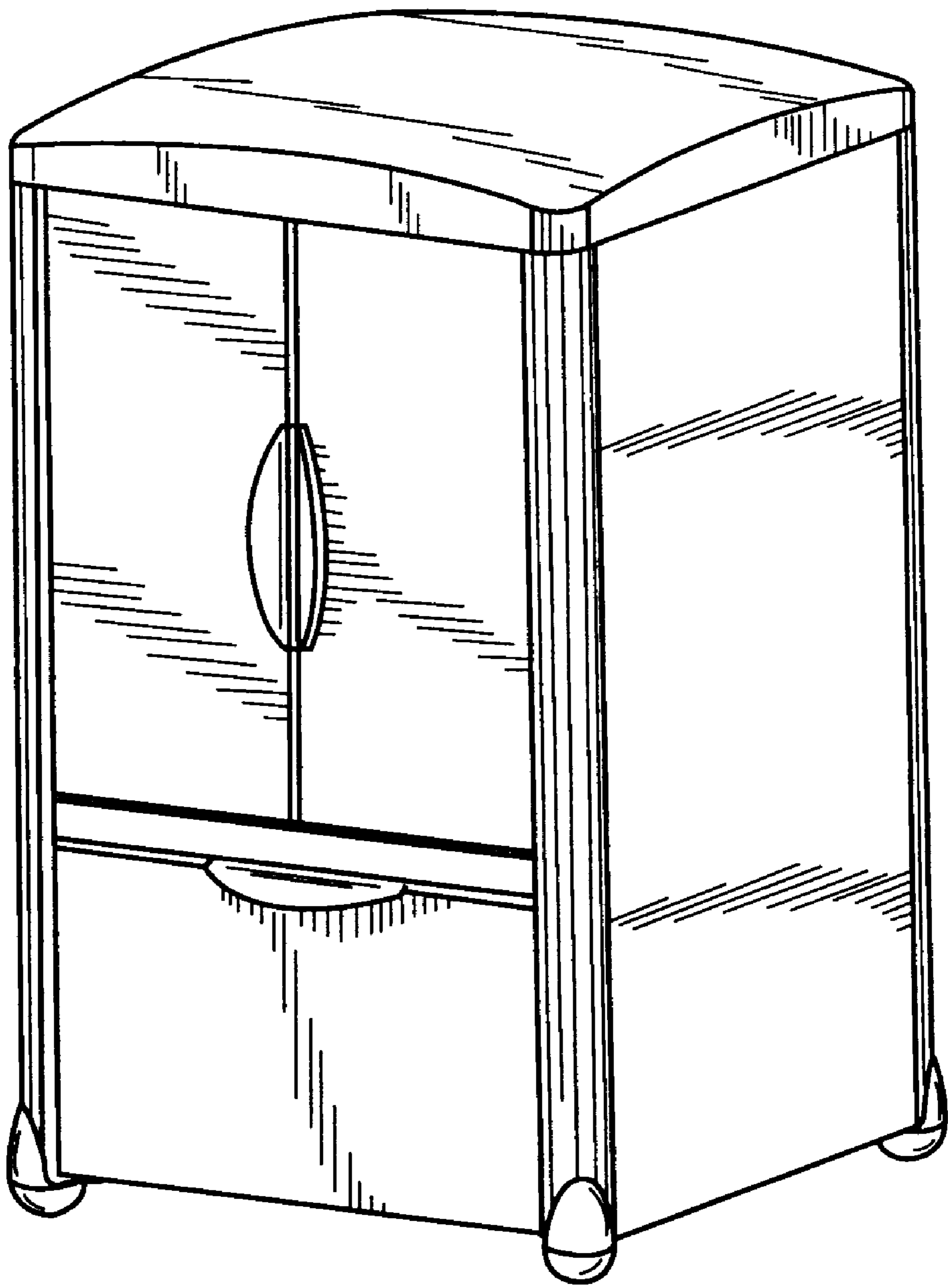

Fig. 11

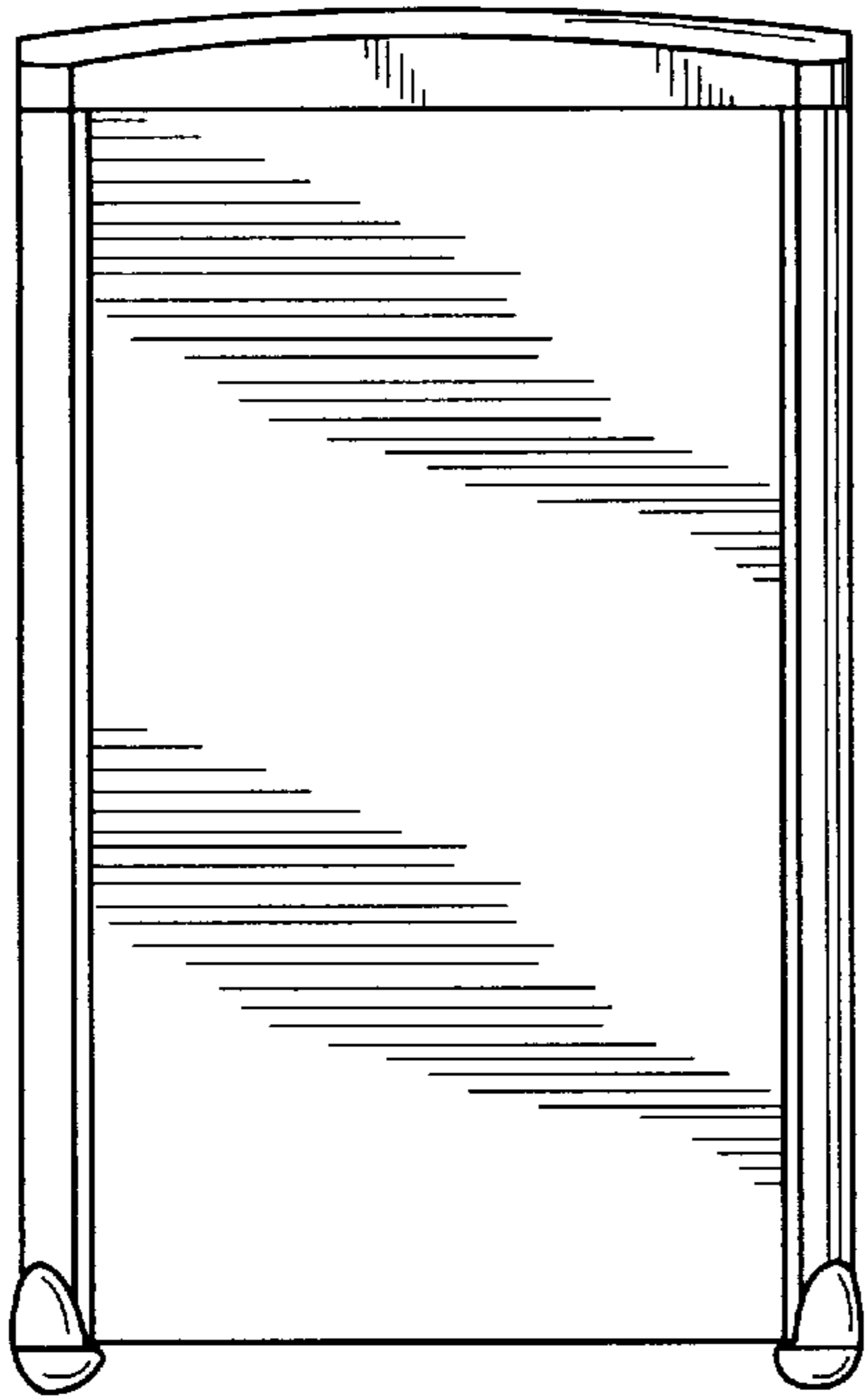

Fig. 13

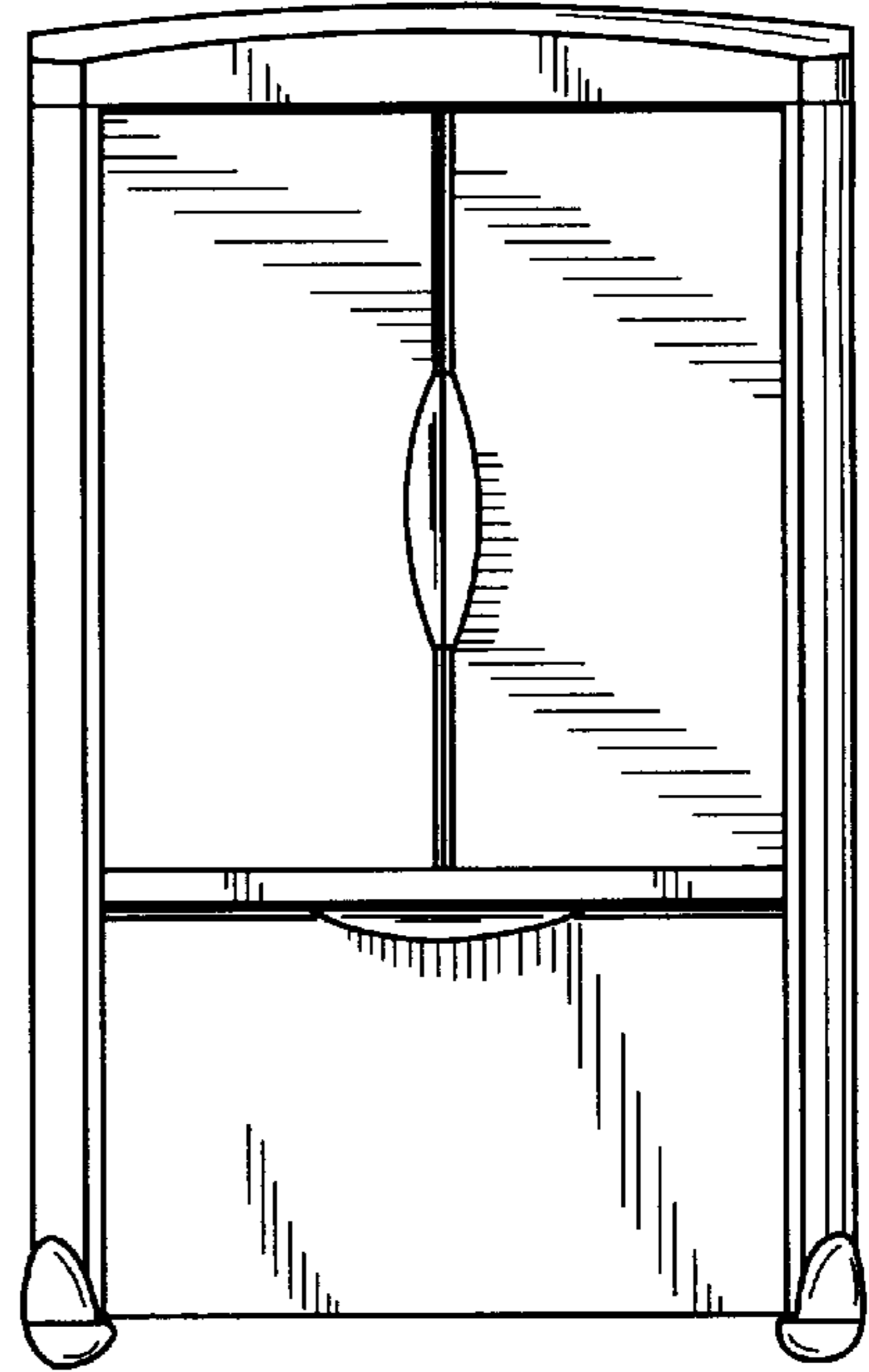

Fig. 12

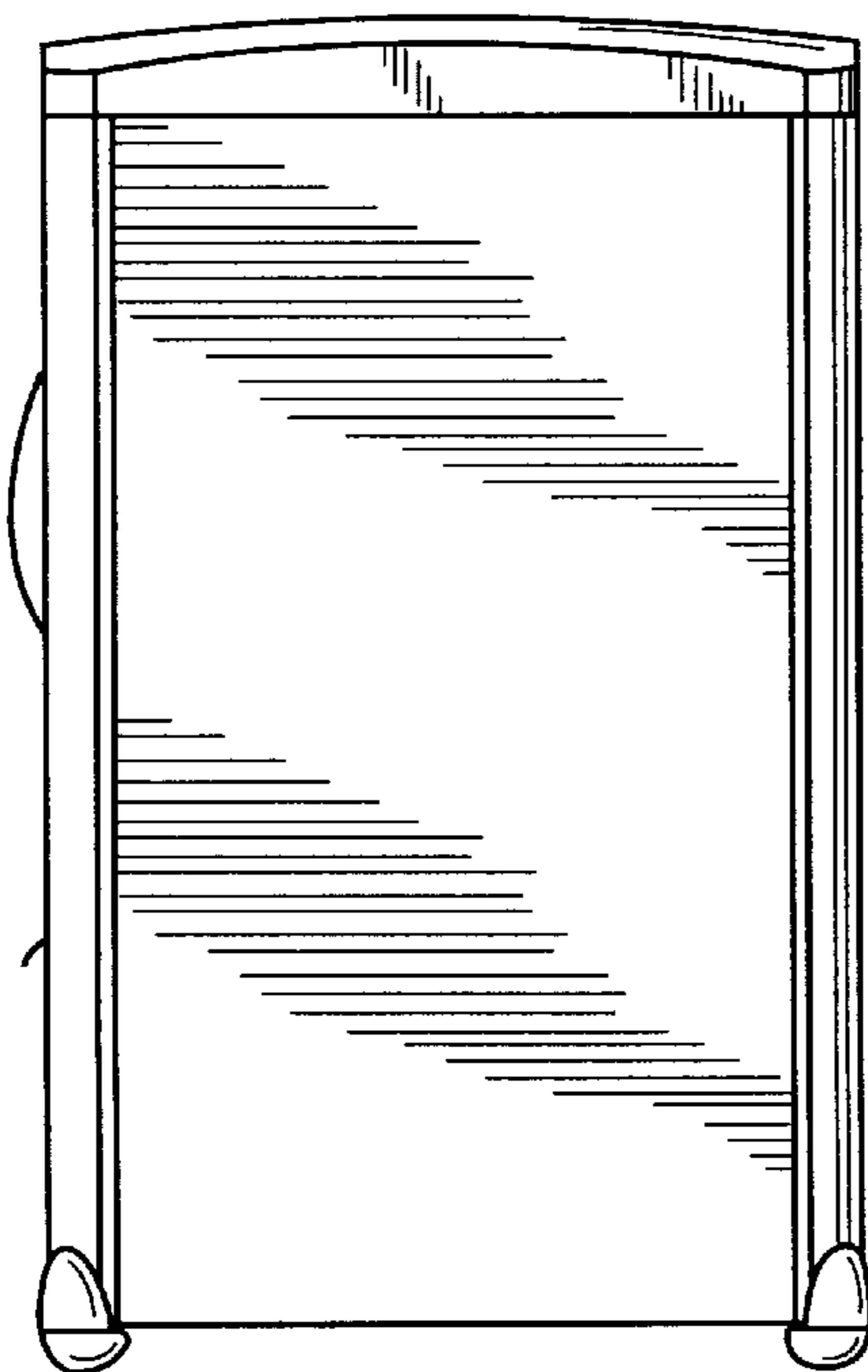

Fig. 14

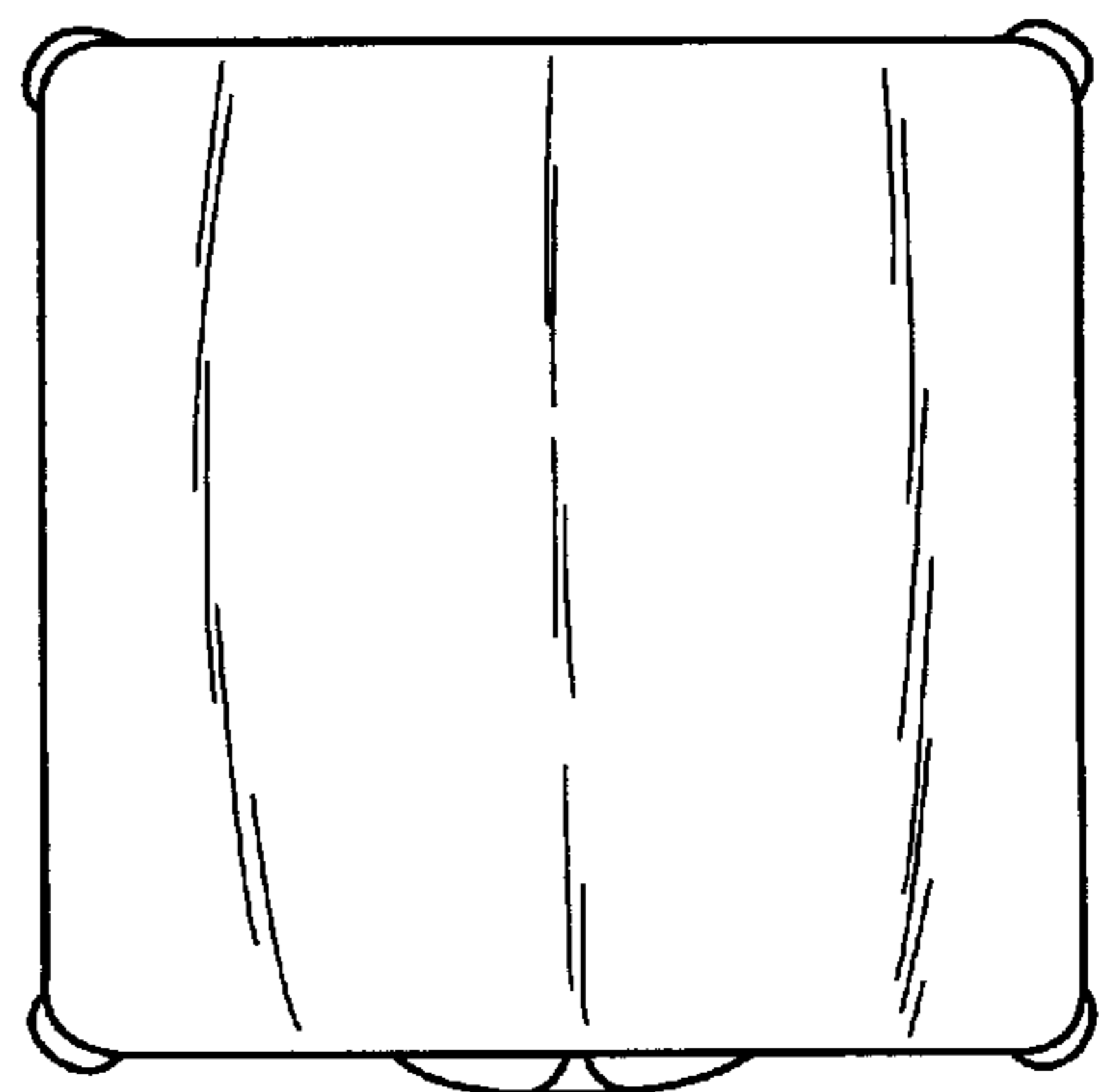

Fig. 15