



US00D431124S

United States Patent [19]

[11] Patent Number: Des. 431,124

Natuzzi et al.

[45] Date of Patent: ** Sep. 26, 2000

[54] SEAT

[75] Inventors: Pasquale Natuzzi; Domenico Abbruzzese, both of Bari, Italy

[73] Assignee: Industrie Natuzzi, SpA, Bari, Italy

[**] Term: 14 Years

[21] Appl. No.: 29/112,380

[22] Filed: Oct. 14, 1999

[51] LOC (7) Cl. 06-01

[52] U.S. Cl. D6/381; D6/334

[58] Field of Search D6/334, 335, 336, D6/364, 371, 373, 381, 500, 501, 502; 5/12.1; 297/232, 445.1

[56] References Cited

U.S. PATENT DOCUMENTS

D. 382,130	8/1997	Natuzzi et al.	D6/381
D. 400,368	11/1998	Natuzzi et al.	D6/381
D. 407,573	4/1999	Natuzzi et al.	D6/381
D. 418,994	1/2000	Natuzzi et al.	D6/381
D. 419,328	1/2000	Natuzzi et al.	D6/381
D. 420,525	2/2000	Watson	D6/381
D. 424,318	5/2000	Natuzzi et al.	D6/381
D. 424,319	5/2000	Natuzzi et al.	D6/381

OTHER PUBLICATIONS

Natuzzi Model 164, Nov. 1986, at International Home Furnishings Market in High Point, North Carolina.

Natuzzi Model 199, Jul. 1987, at International Home Furnishings Market in High Point, North Carolina.

Natuzzi Model 414, Oct. 1987, at International Home Furnishings Market in High Point, North Carolina.

Natuzzi Model 426, Apr. 1988, at International Home Furnishings Market in High Point, North Carolina.

Natuzzi Model 748, Apr. 1990, at International Home Furnishings Market in High Point, North Carolina.

Natuzzi Model 756, Apr. 1990, at International Home Furnishings Market in High Point, North Carolina.

Natuzzi Model 758, Apr. 1990, at International Home Furnishings Market in High Point, North Carolina.

Natuzzi Model 771, Oct. 1990, at International Home Furnishings Market in High Point, North Carolina.

Natuzzi Model 798, Oct. 1990, at International Home Furnishings Market in High Point, North Carolina.

Natuzzi Model 805, Oct. 1990, at International Home Furnishings Market in High Point, North Carolina.

Natuzzi Model 845, Apr. 1991, at International Home Furnishings Market in High Point, North Carolina.

Natuzzi Model 848, Apr. 1991, at International Home Furnishings Market in High Point, North Carolina.

Natuzzi Model 1068, May 1993, at International Home Furnishings Market in High Point, North Carolina.

Natuzzi Model 1102, Oct. 1993, at International Home Furnishings Market in High Point, North Carolina.

Natuzzi Model 1123, Jan. 1994, at International Home Furnishings Market in High Point, North Carolina.

Natuzzi Model 1207, Oct. 1994, at International Home Furnishings Market in High Point, North Carolina.

Natuzzi Model 1349, Sep. 1995, at International Home Furnishings Market in High Point, North Carolina.

Natuzzi Model 1442, Apr. 1996, at International Home Furnishings Market in High Point, North Carolina.

Natuzzi Model 1458, Apr. 1996, at International Home Furnishings Market in High Point, North Carolina.

Natuzzi Model 1459, Apr. 1996, at International Home Furnishings Market in High Point, North Carolina.

Natuzzi Model 1480, Sep. 1996, at International Home Furnishings Market in High Point, North Carolina.

Natuzzi Model 1563, Apr. 1997, at International Home Furnishings Market in High Point, North Carolina.

Natuzzi Model 1565, Apr. 1997, at International Home Furnishings Market in High Point, North Carolina.

Natuzzi Model 1592, Apr. 1997, at International Home Furnishings Market in High Point, North Carolina.

Natuzzi Model 1603, Apr. 1997, at International Home Furnishings Market in High Point, North Carolina.

Natuzzi Model 1665, Apr. 1998, at International Home Furnishings Market in High Point, North Carolina.

Natuzzi Model 1702, Apr. 1998, at International Home Furnishings Market in High Point, North Carolina.

Natuzzi Model 1719, Sep. 1998, at International Home Furnishings Market in High Point, North Carolina.

Natuzzi Model 1720, Sep. 1998, at International Home Furnishings Market in High Point, North Carolina.

Natuzzi Model 1725, Sep. 1998, at International Home Furnishings Market in High Point, North Carolina.

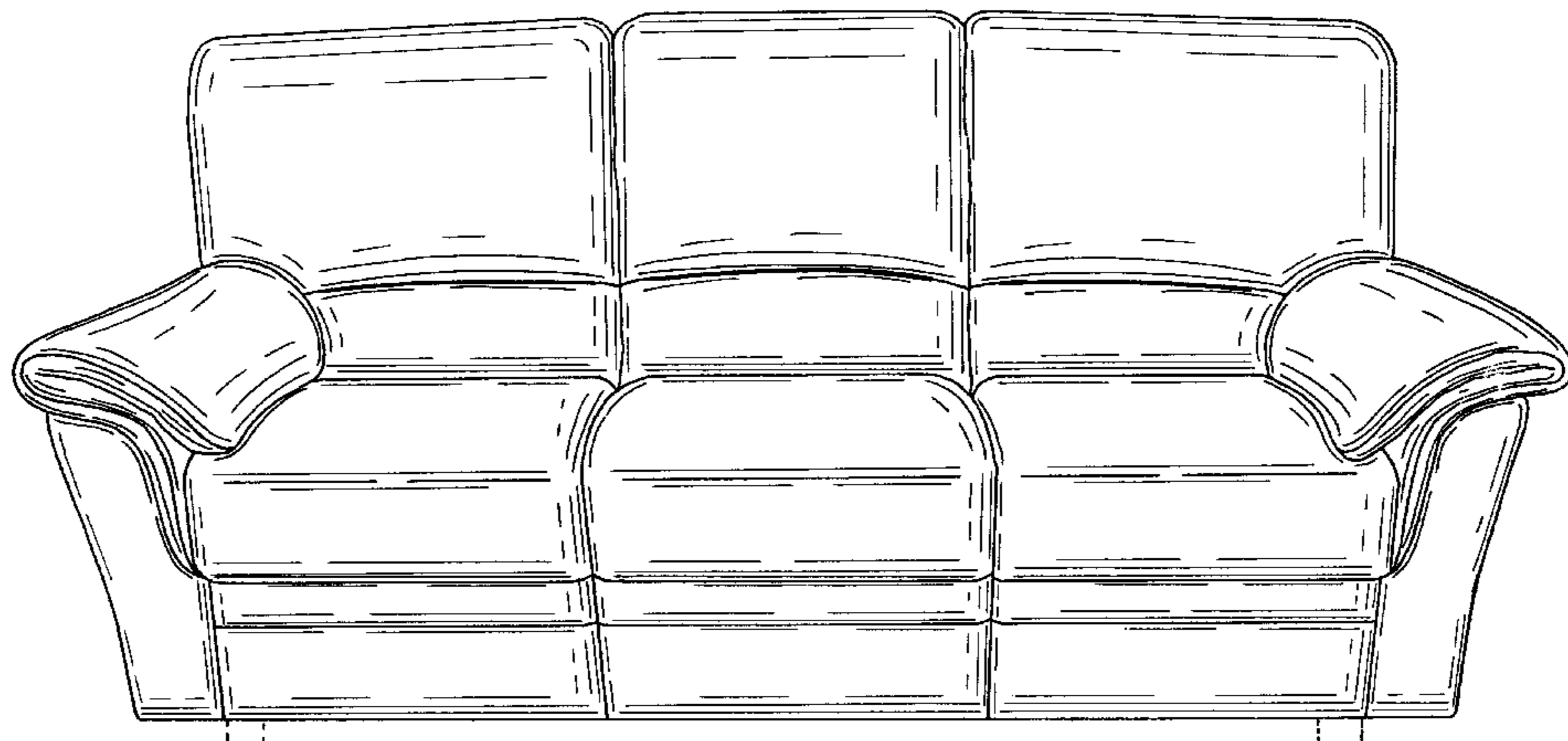

Primary Examiner—Gary D. Watson
Attorney, Agent, or Firm—Alston & Bird LLP

[57]

CLAIM

The ornamental design for a seat, as shown and described.

DESCRIPTION

FIG. 1 is a front perspective view of a seat showing our new design in the form of a sofa;

FIG. 2 is a front elevational view thereof;

FIG. 3 is a top plan view thereof;

FIG. 4 is a right side elevational view, the left side being a mirror image thereof;

FIG. 5 is a rear perspective view thereof;

FIG. 6 is a front elevational view of a seat showing our new design in the form of a loveseat; and,

FIG. 7 is a front elevational view of a seat showing our new design in the form of a chair.

The broken lines shown herein are for illustrative purposes only and form no part of the claimed design.

The rear views of FIGS. 6 and 7 are like FIG. 5, the difference being a matter of length.

The end views of FIGS. 6 and 7 are like FIG. 4.

FIG. 1 is shown on an enlarged scale and FIGS. 4 and 5 are shown on a reduced scale with respect to the other views.

1 Claim, 3 Drawing Sheets

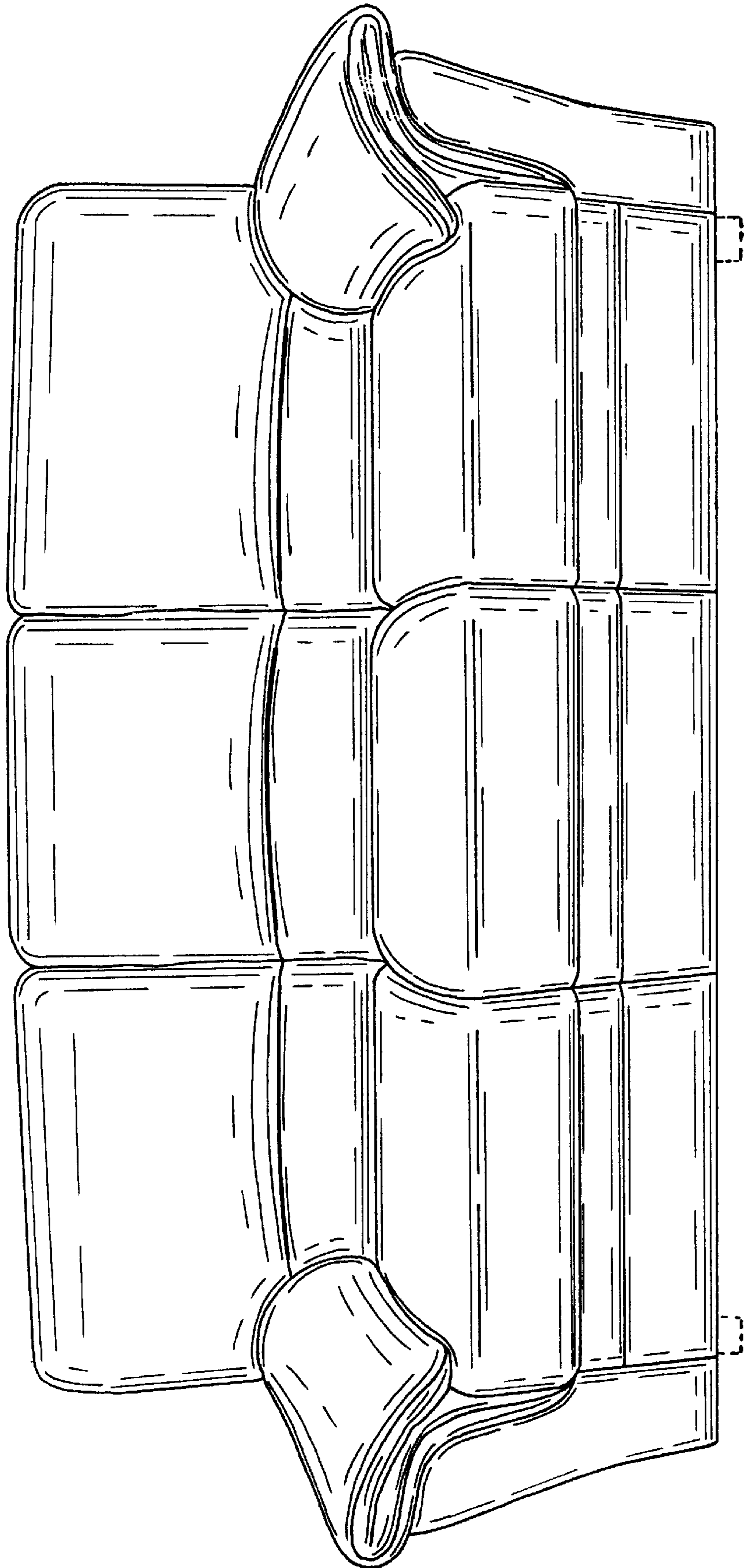

FIG. 1.



FIG. 2.

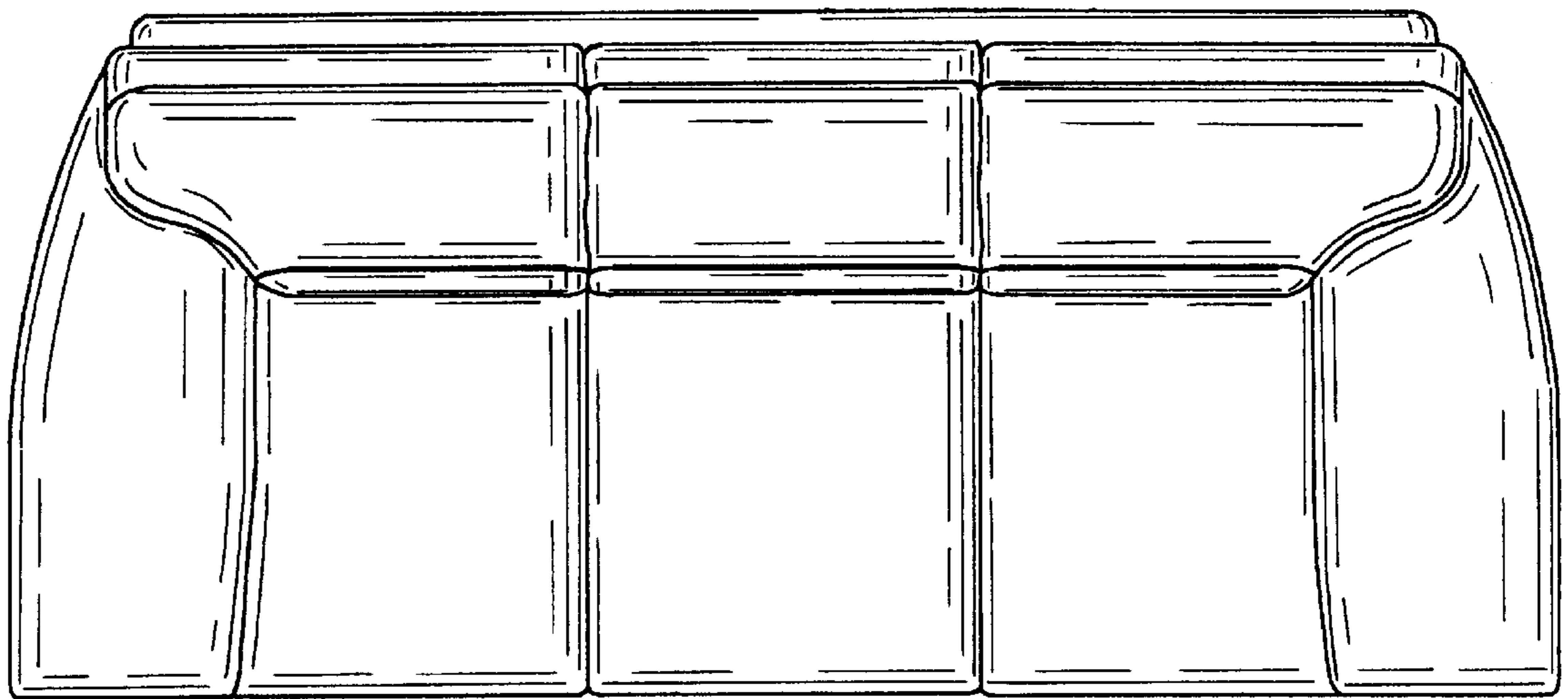

FIG. 3.

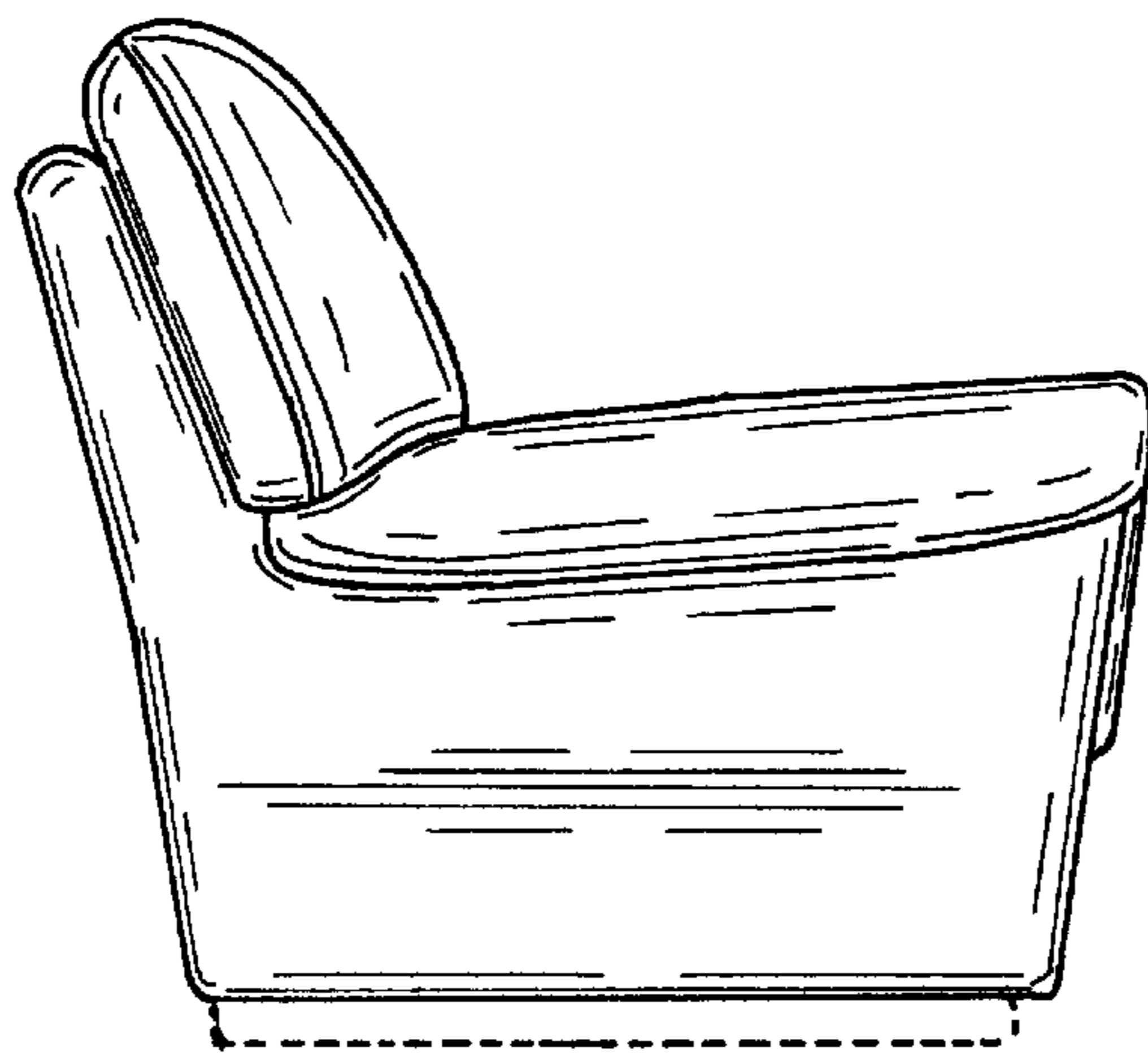

FIG. 4.

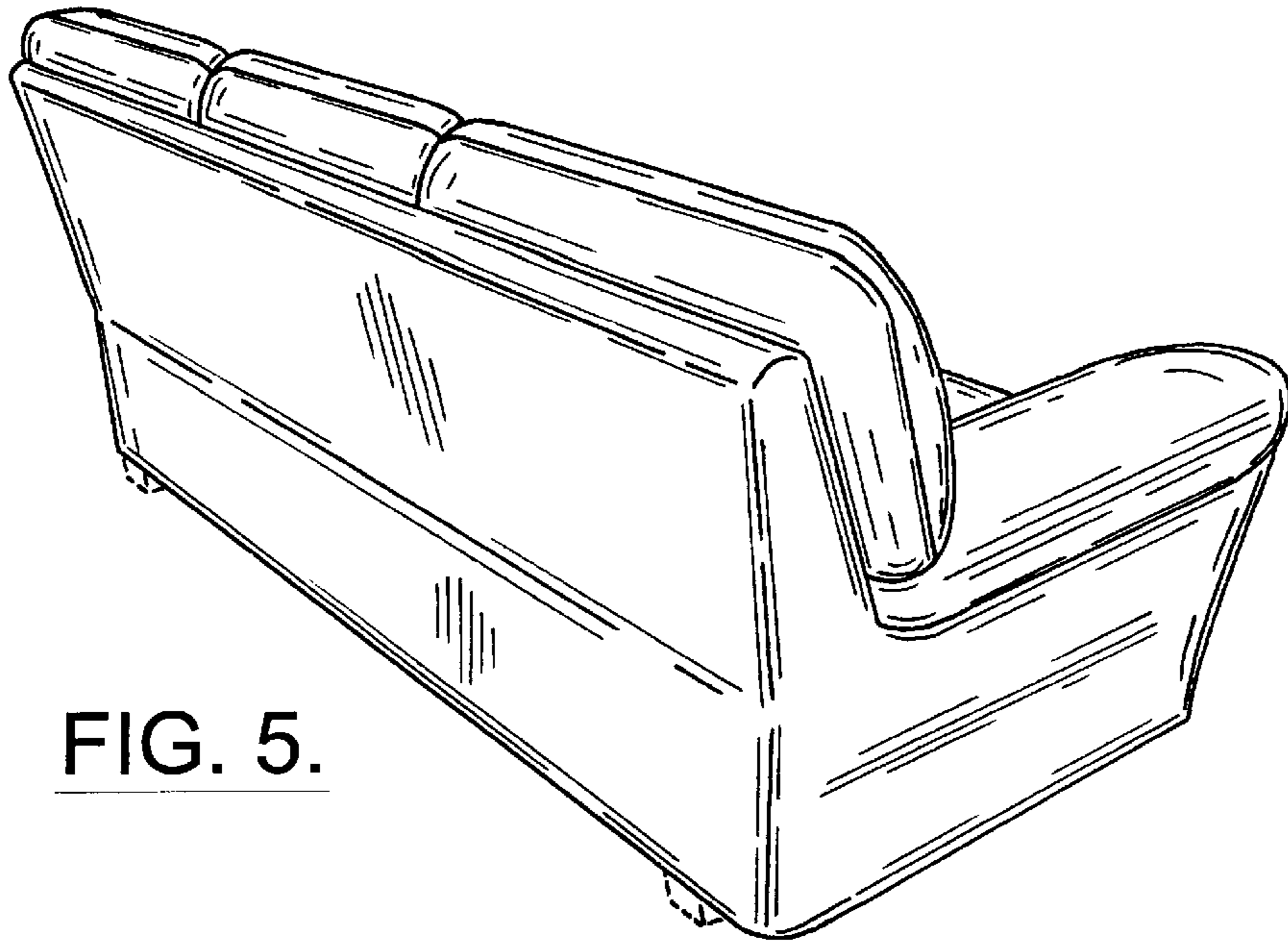

FIG. 5.

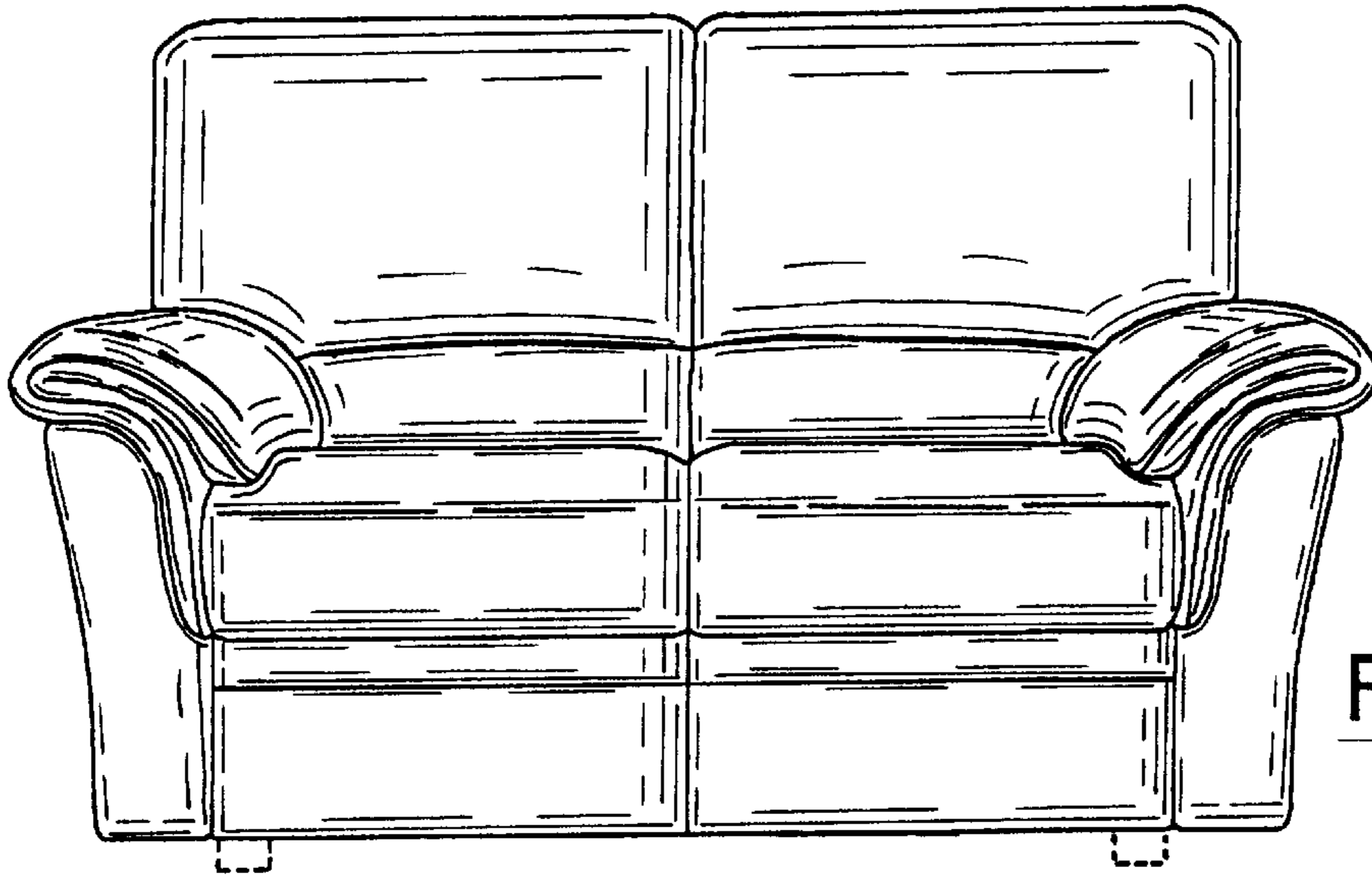

FIG. 6.

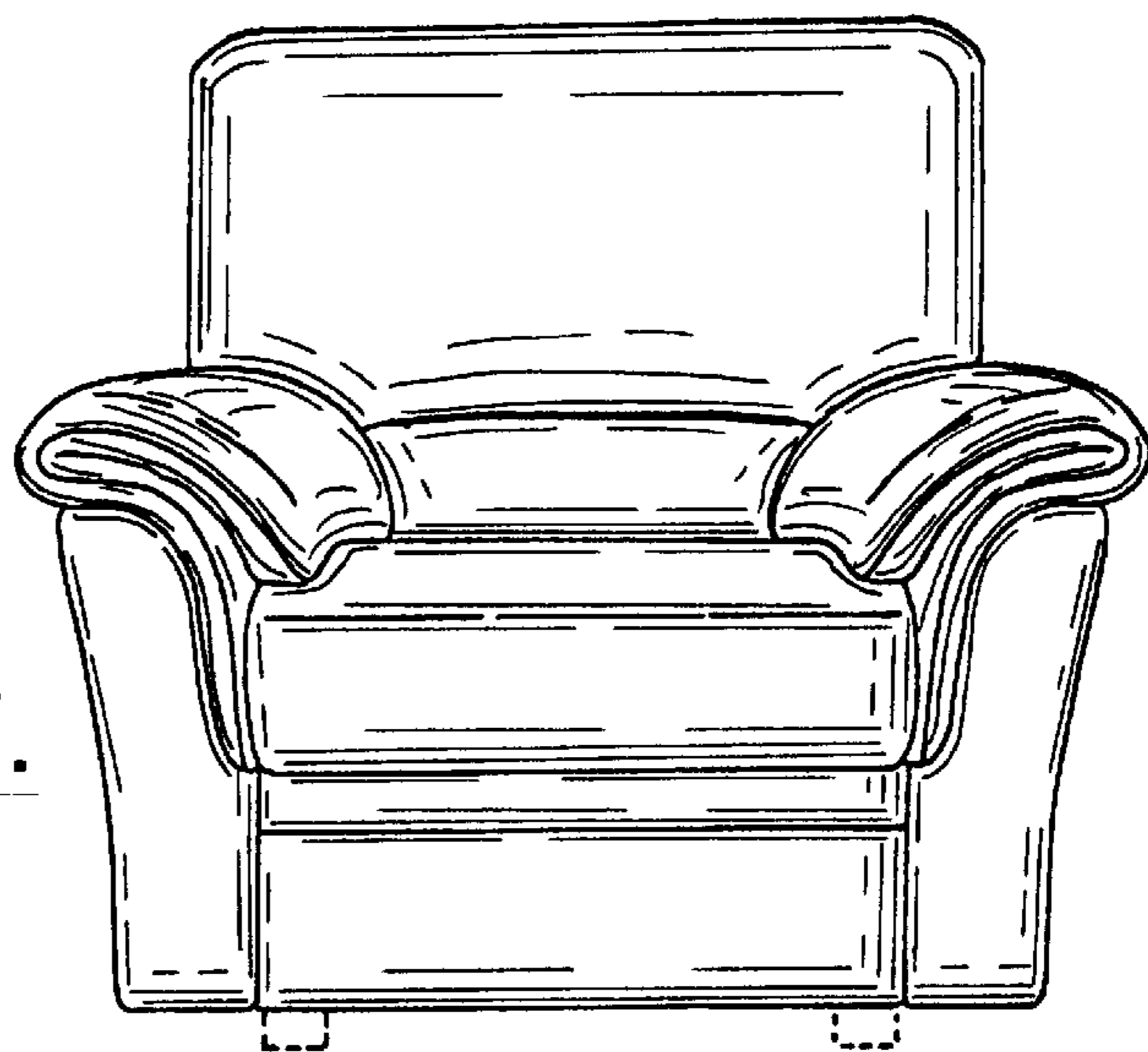

FIG. 7.