



US00D431122S

United States Patent [19]
Koncar

[11] **Patent Number: Des. 431,122**

[45] **Date of Patent: ** Sep. 26, 2000**

[54] **FRONT PARLOR SOFA**

Attorney, Agent, or Firm—Arter & Hadden LLP

[75] Inventor: **John Florian Koncar**, Cleveland, Ohio

[57] **CLAIM**

[73] Assignee: **Florian Enterprises, Inc.**

The ornamental design for a front parlour sofa, as shown and described.

[**] Term: **14 Years**

[21] Appl. No.: **29/103,197**

DESCRIPTION

[22] Filed: **Apr. 9, 1999**

[51] **LOC (7) Cl.** **06-01**

[52] **U.S. Cl.** **D6/381**

[58] **Field of Search** D6/334, 335, 364,
D6/371, 373, 381, 500, 501, 502; 297/232

FIG. 1 is a perspective view of the front parlour sofa of the invention;

FIG. 2 is a front view of the front parlour sofa of the invention;

[56] **References Cited**

U.S. PATENT DOCUMENTS

D. 177,455	4/1956	Young	D6/381
D. 360,997	8/1995	Hutton	D6/381
D. 382,129	8/1997	Lewis	D6/381
D. 388,630	1/1998	Lowman et al.	D6/381
D. 391,779	3/1998	Gohman	D6/381
D. 404,212	1/1999	Hutton	D6/381

FIG. 3 is a rear view of the front parlour sofa of the invention;

FIG. 4 is a side view of the front parlour sofa of the invention, the opposite side being a mirror image thereof;

FIG. 5 is a top view of the front parlour sofa of the invention; and,

FIG. 6 is a bottom view of the front parlour sofa of the invention.

OTHER PUBLICATIONS

NHFA's Competitive Edge, p. 61, Sofa shown at bottom right, Apr. 1983.

Primary Examiner—Gary D. Watson

1 Claim, 3 Drawing Sheets

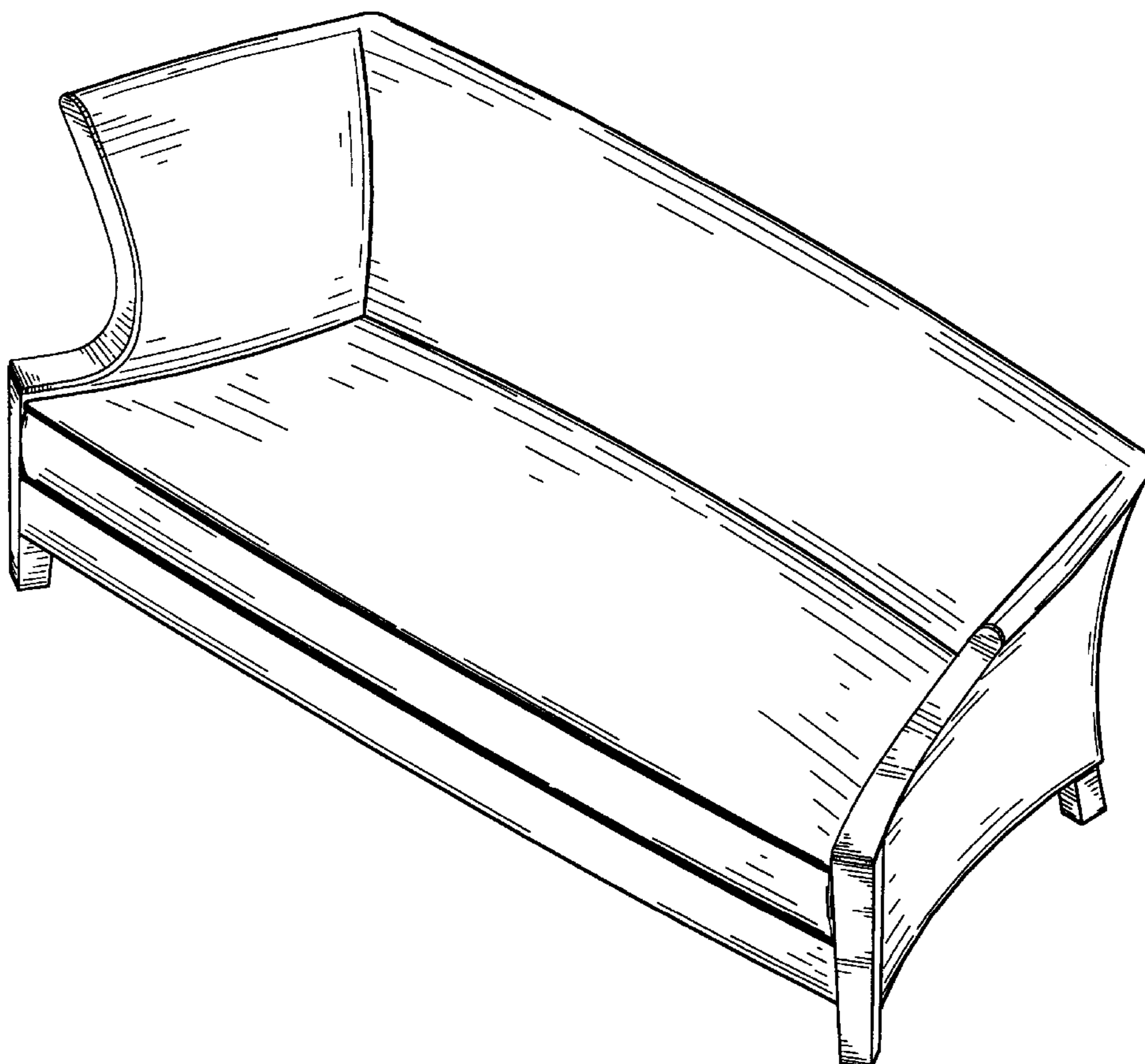

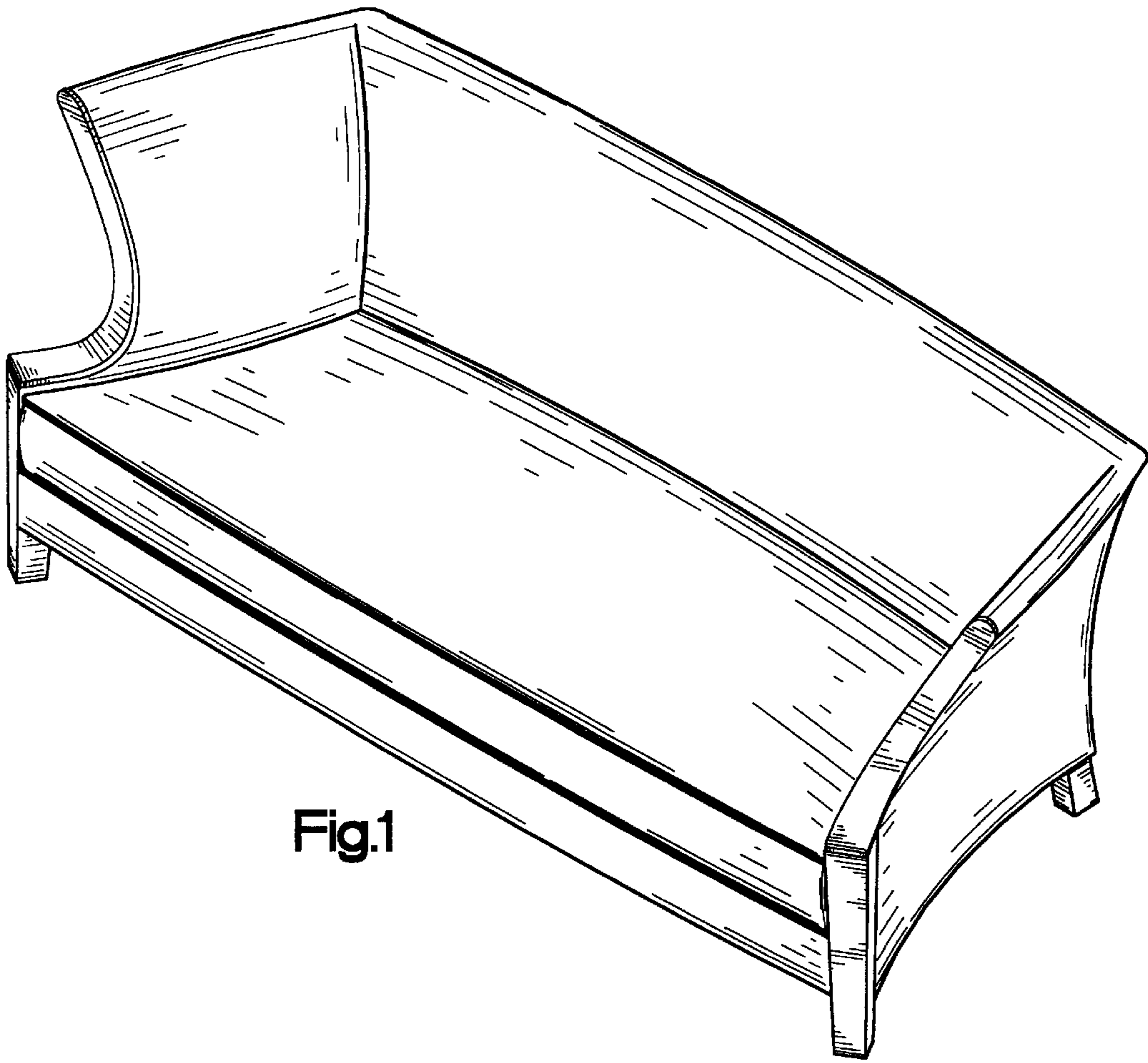

Fig.1

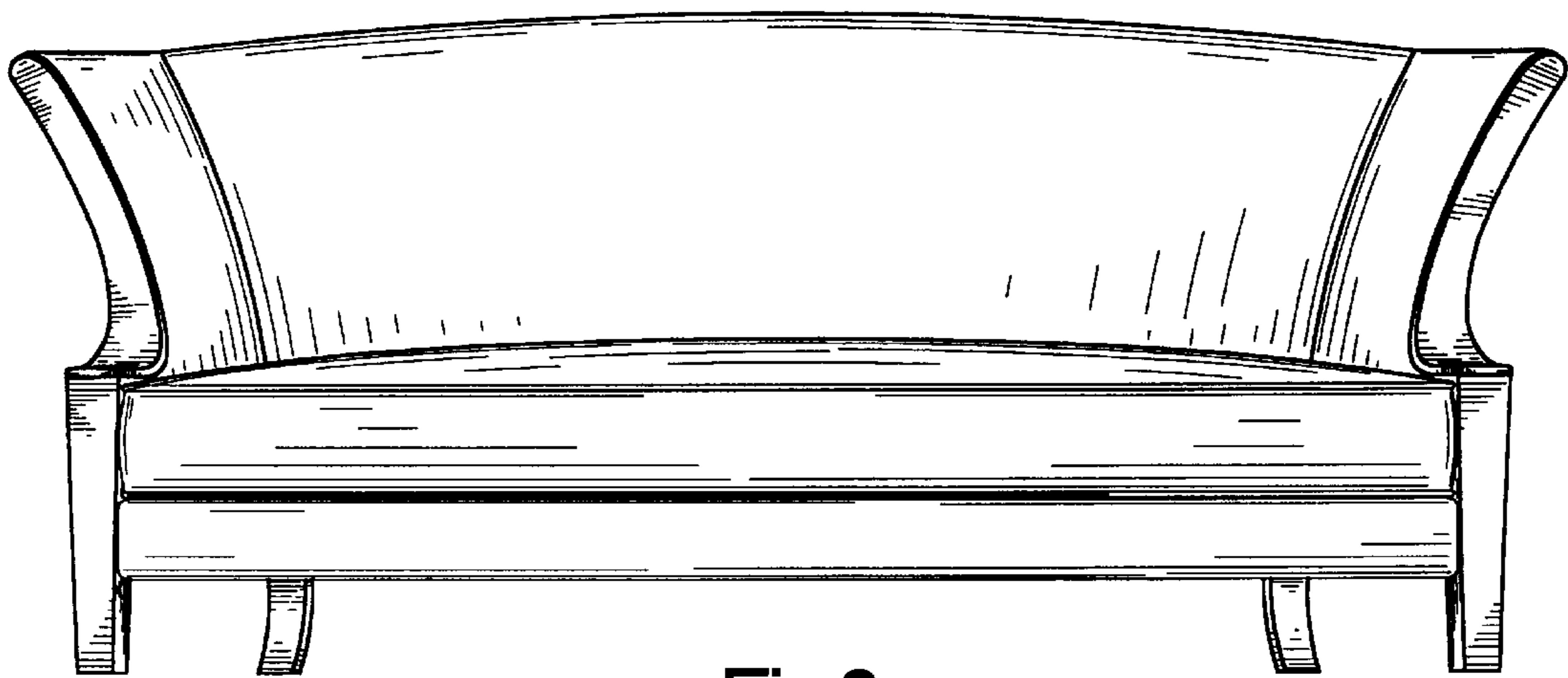

Fig.2

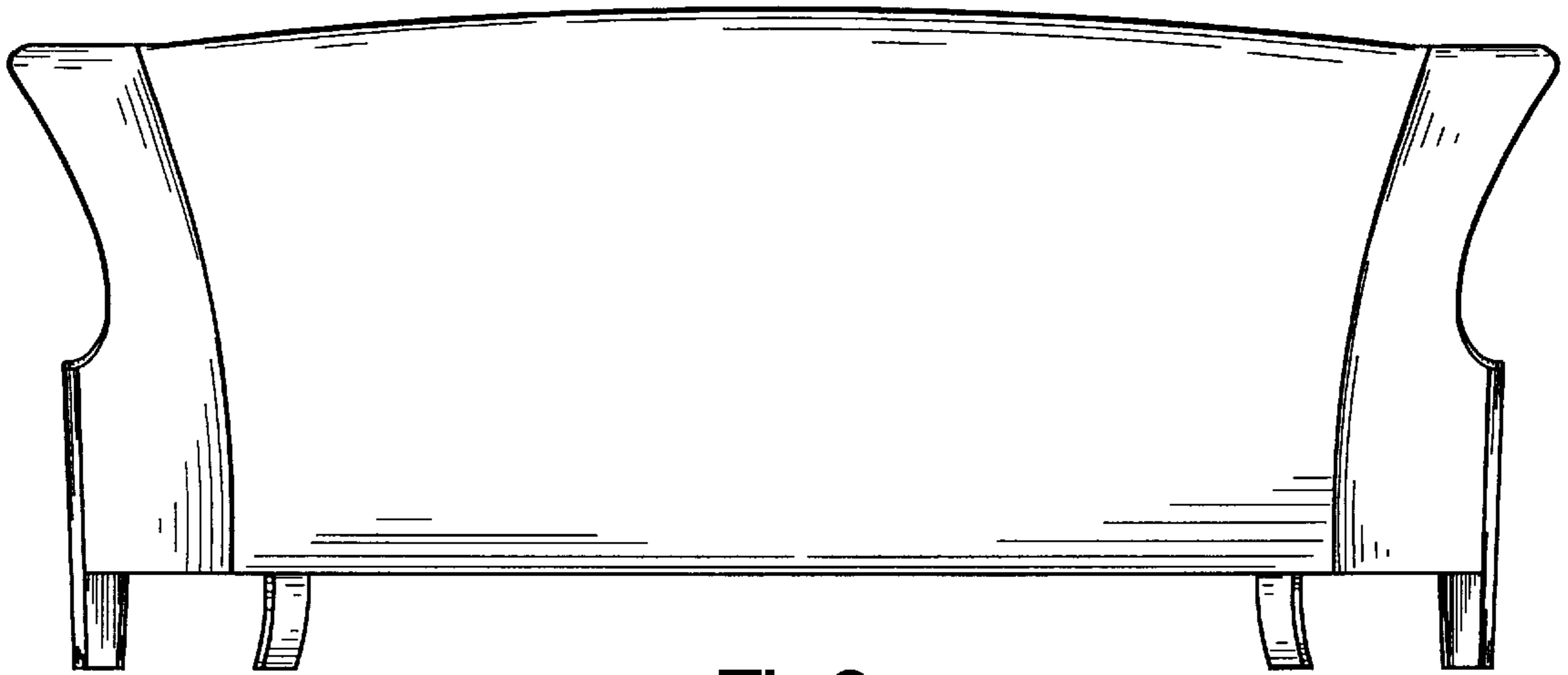
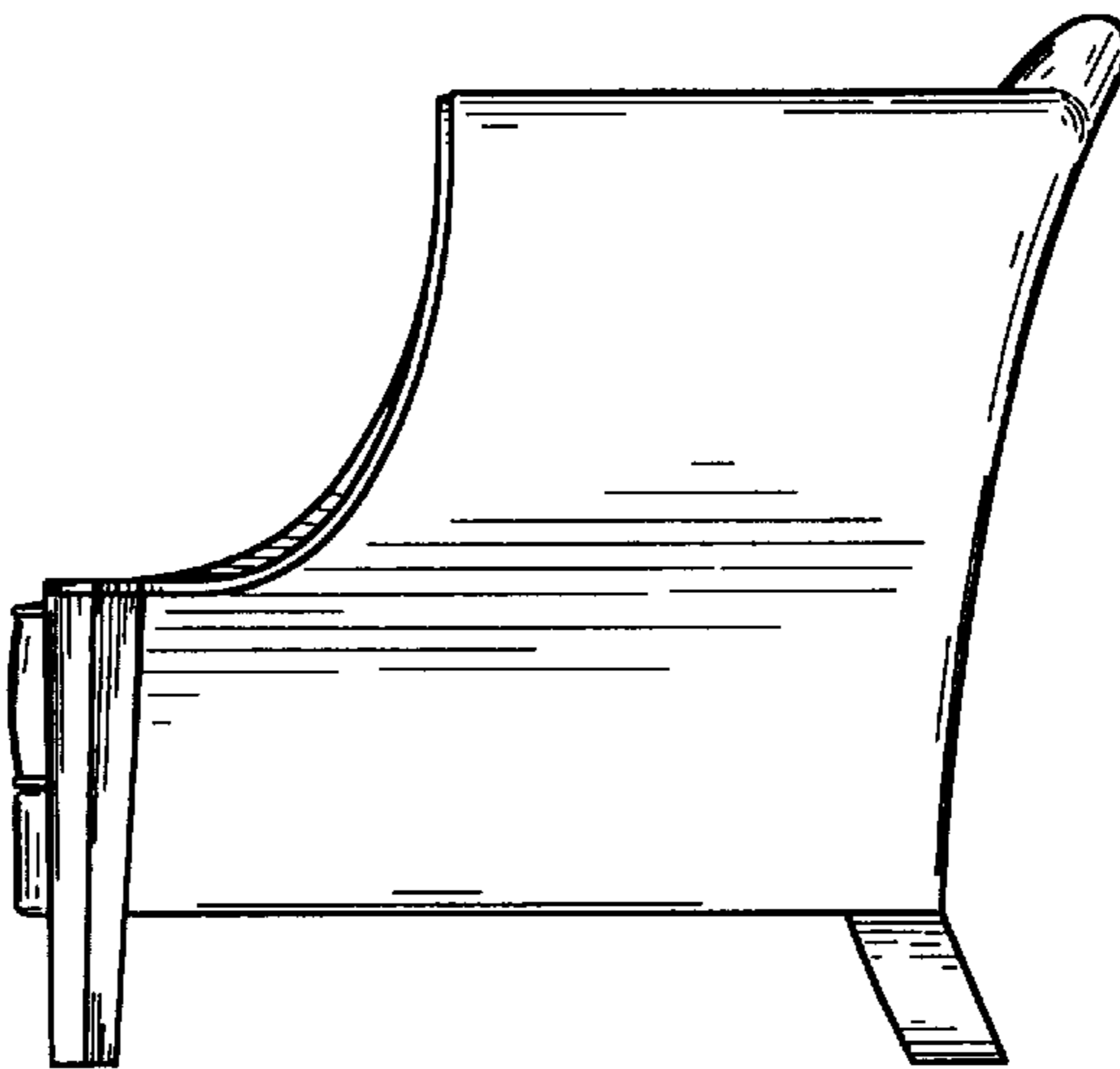

Fig.3

Fig.4



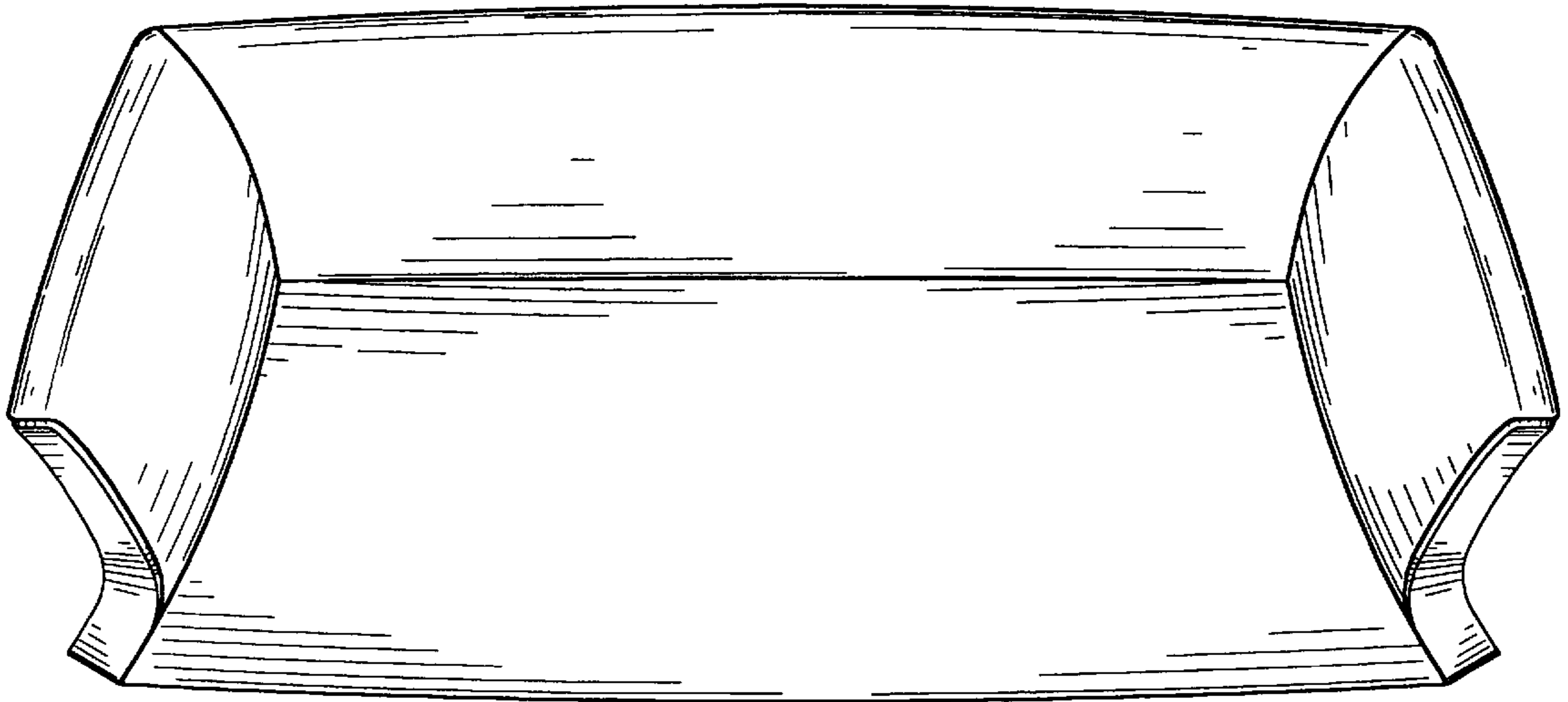

Fig.5

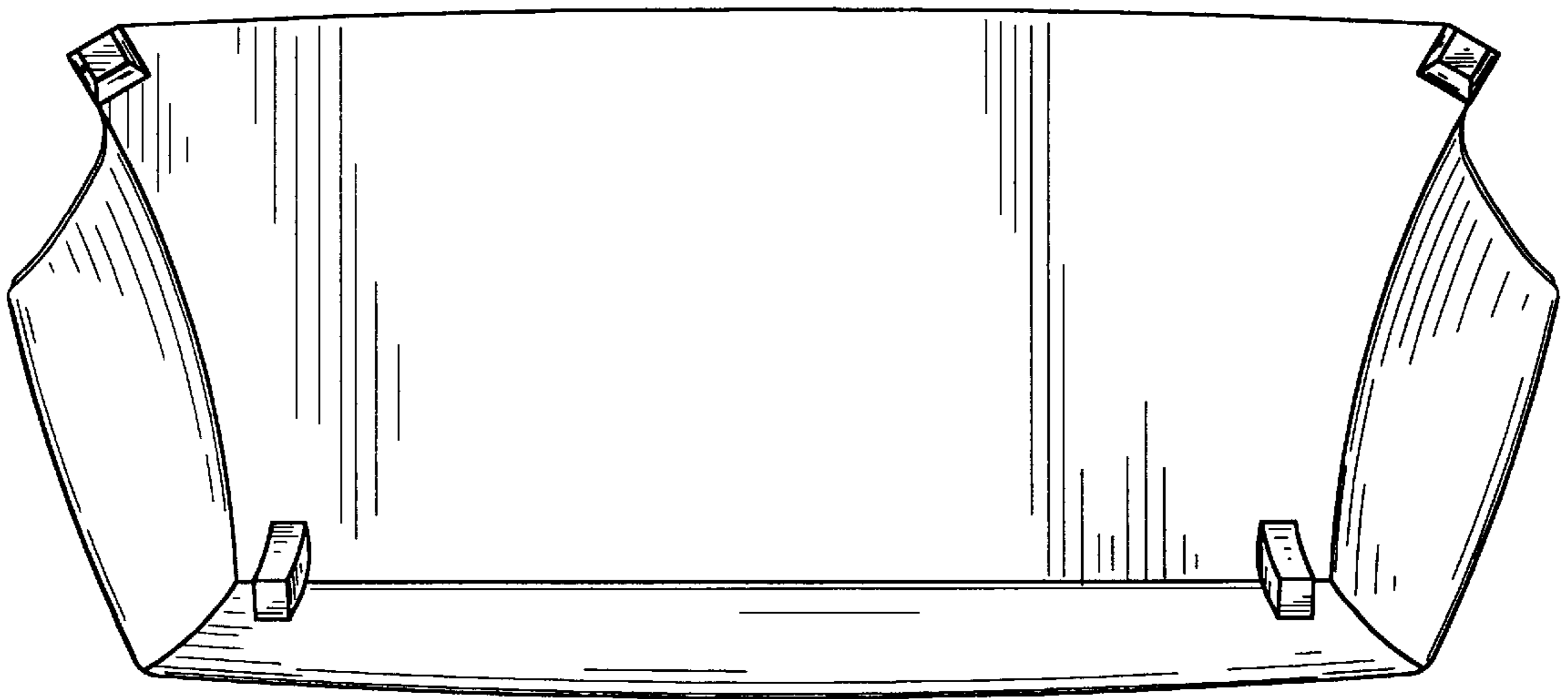

Fig.6