



US00D431121S

United States Patent [19]

Matthew

[11] **Patent Number: Des. 431,121**

[45] **Date of Patent: ** Sep. 26, 2000**

[54] **THERAPEUTIC CHAIR**

[76] Inventor: **Jacqueline Matthew**, 671 W. A St.
#101, Hayward, Calif. 94541

[**] Term: **14 Years**

[21] Appl. No.: **29/115,812**

[22] Filed: **Dec. 21, 1999**

[51] **LOC (7) Cl.** **06-01**

[52] **U.S. Cl.** **D6/379; D6/374**

[58] **Field of Search** D6/334, 371, 373,
D6/374, 375, 379, 380, 500, 501, 502;
297/445.6, 446.1

[56] **References Cited**

U.S. PATENT DOCUMENTS

D. 183,009	6/1958	MacKintosh	D6/375
D. 213,438	3/1969	Koch	D6/374
D. 219,032	10/1970	Christenson, Jr.	D6/374
D. 238,990	3/1976	Galvez	D6/374

D. 256,970	9/1980	Cassina	D6/334
D. 265,954	8/1982	Aulenti	D6/379
D. 270,406	9/1983	Schultz	D6/373
4,768,834	9/1988	Walsh	D6/334 X

Primary Examiner—Gary D. Watson
Attorney, Agent, or Firm—Goldstein & Canino

[57] CLAIM

The ornamental design for a therapeutic chair, as shown and described.

DESCRIPTION

FIG. 1 is a perspective view of a therapeutic chair.
FIG. 2 is a front elevational view thereof.
FIG. 3 is a rear elevational view thereof.
FIG. 4 is a left side elevational view thereof, the right side elevational view being a mirror image of the left side view.
FIG. 5 is a top plan view of the therapeutic chair; and,
FIG. 6 is a bottom plan view thereof.

1 Claim, 3 Drawing Sheets

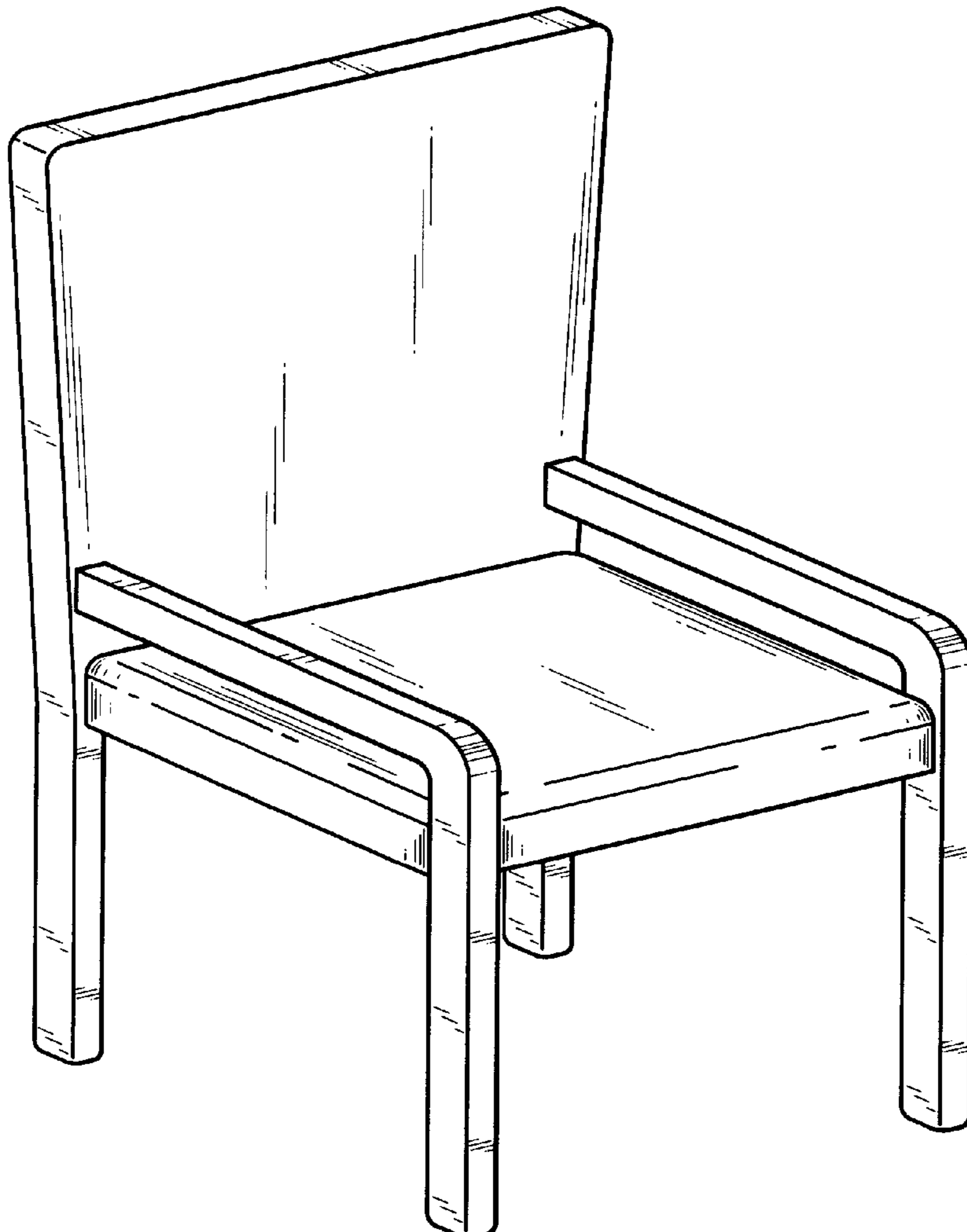

FIG. 1

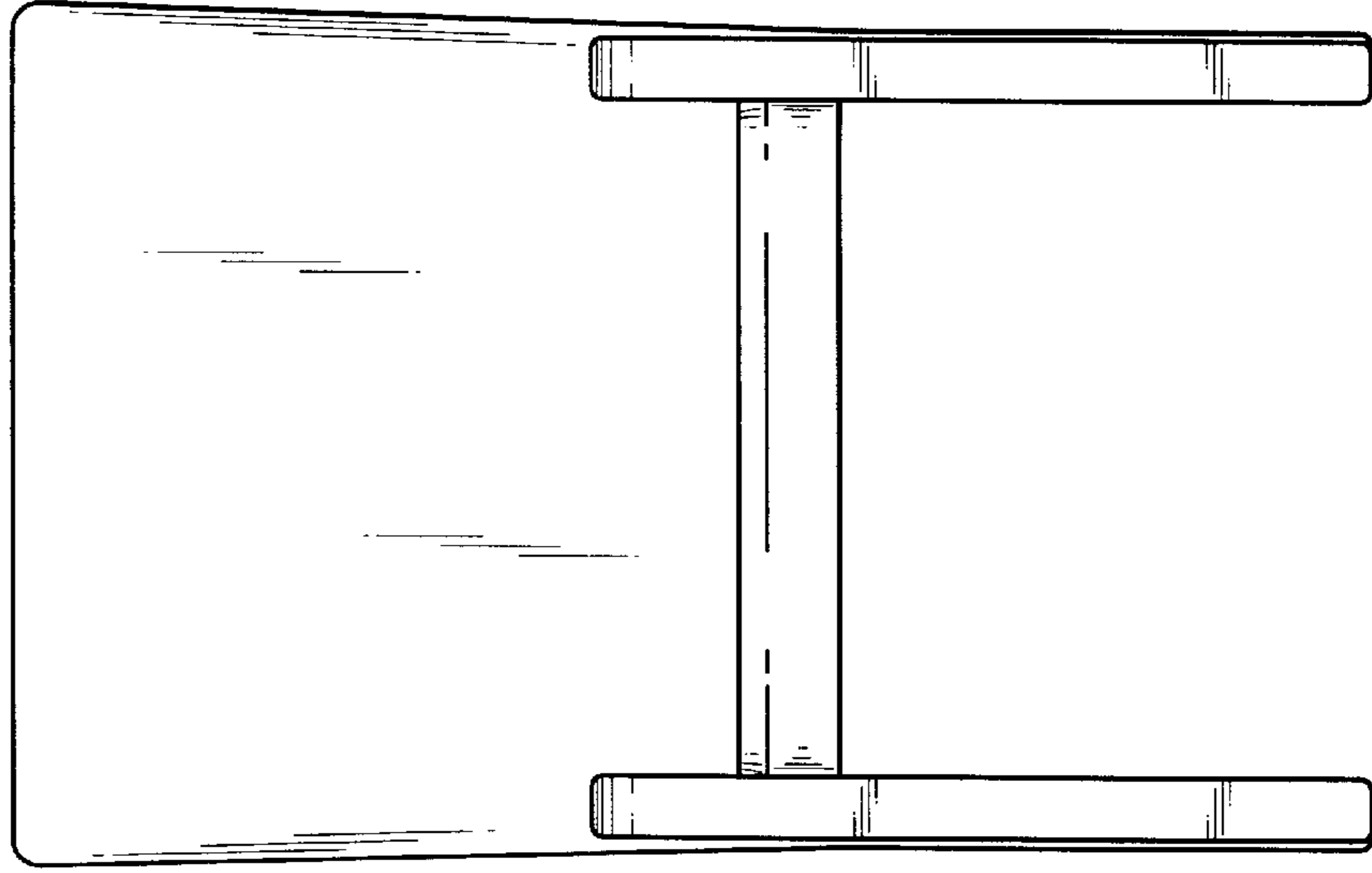
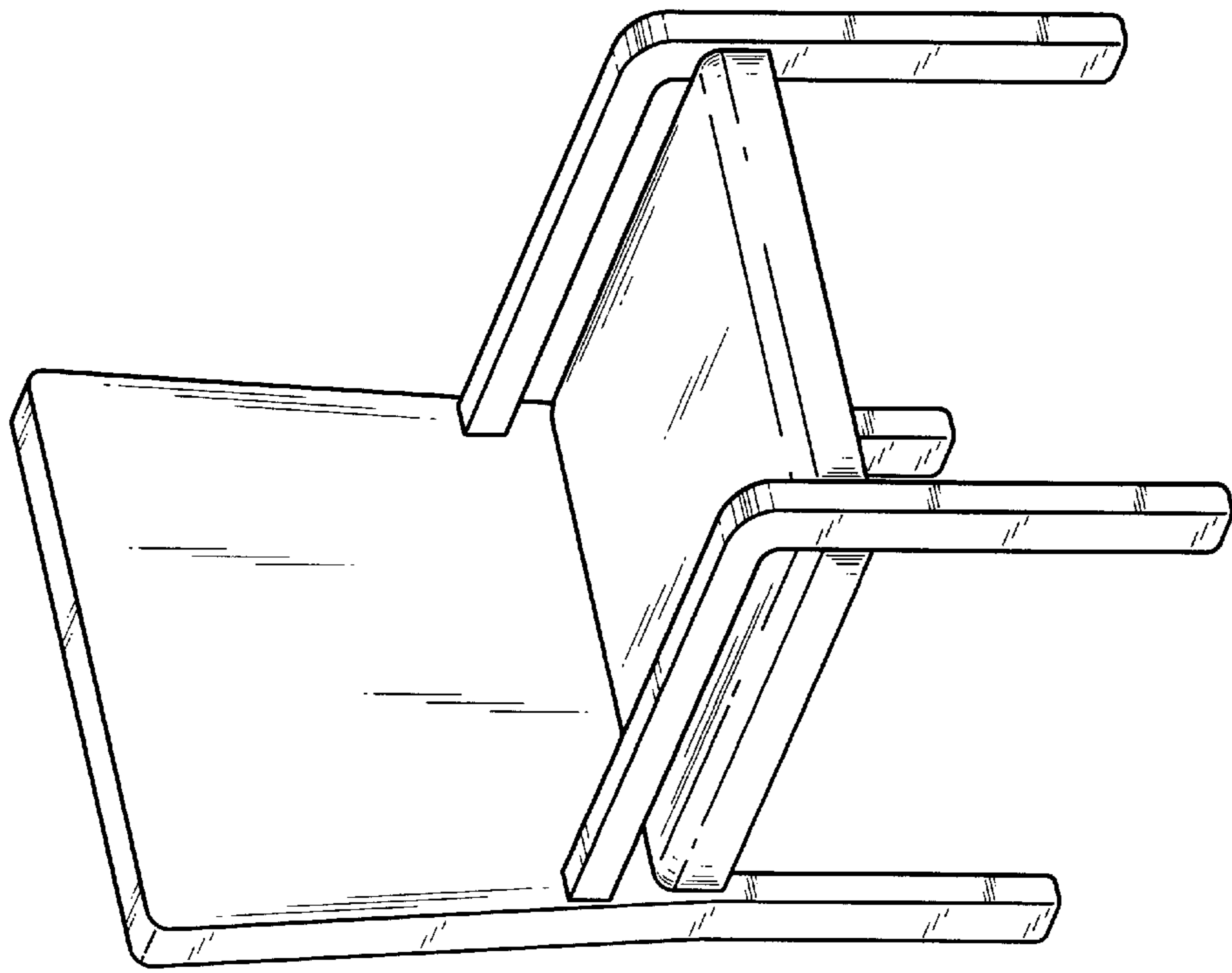

FIG. 2

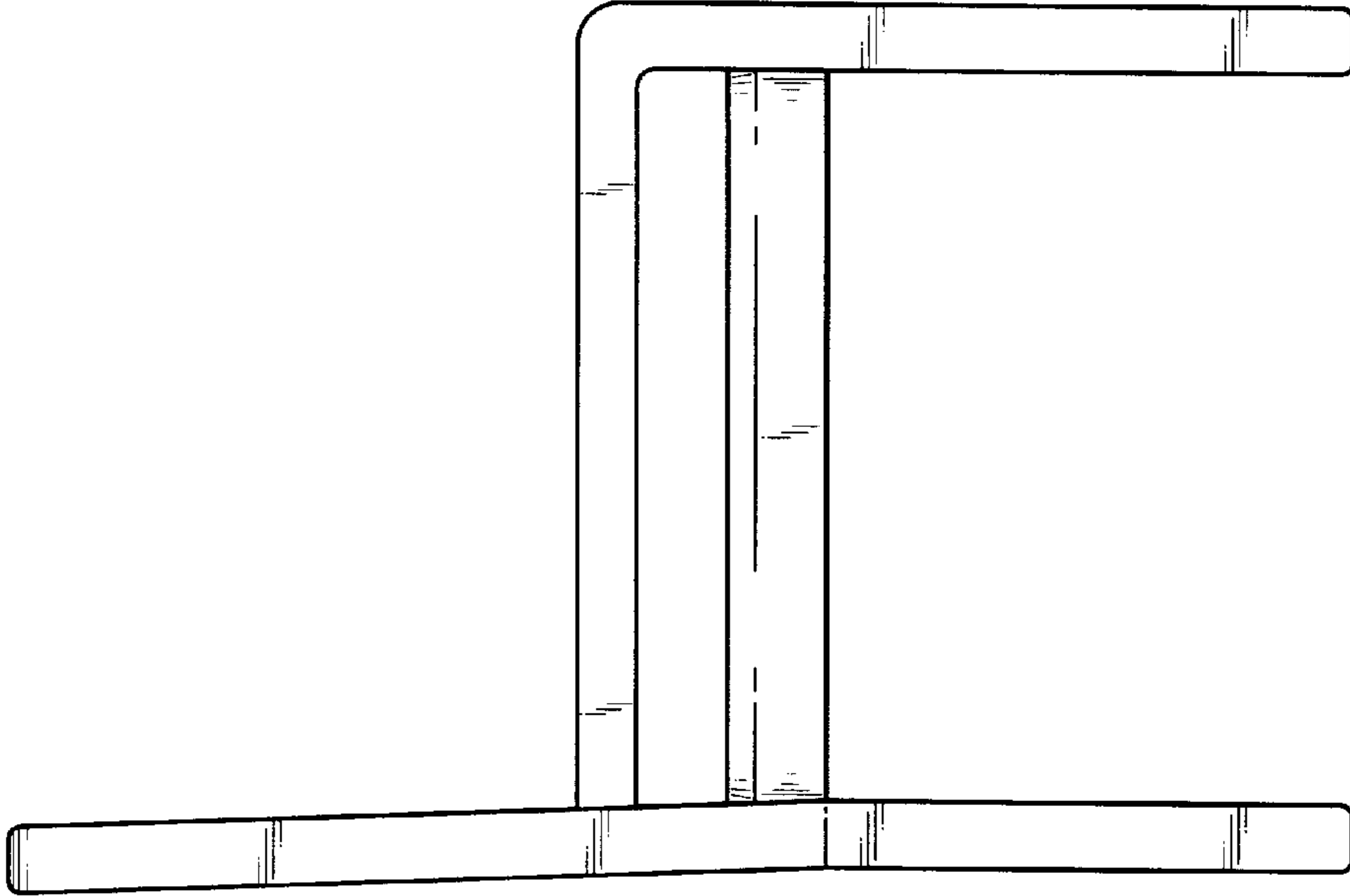

FIG. 3

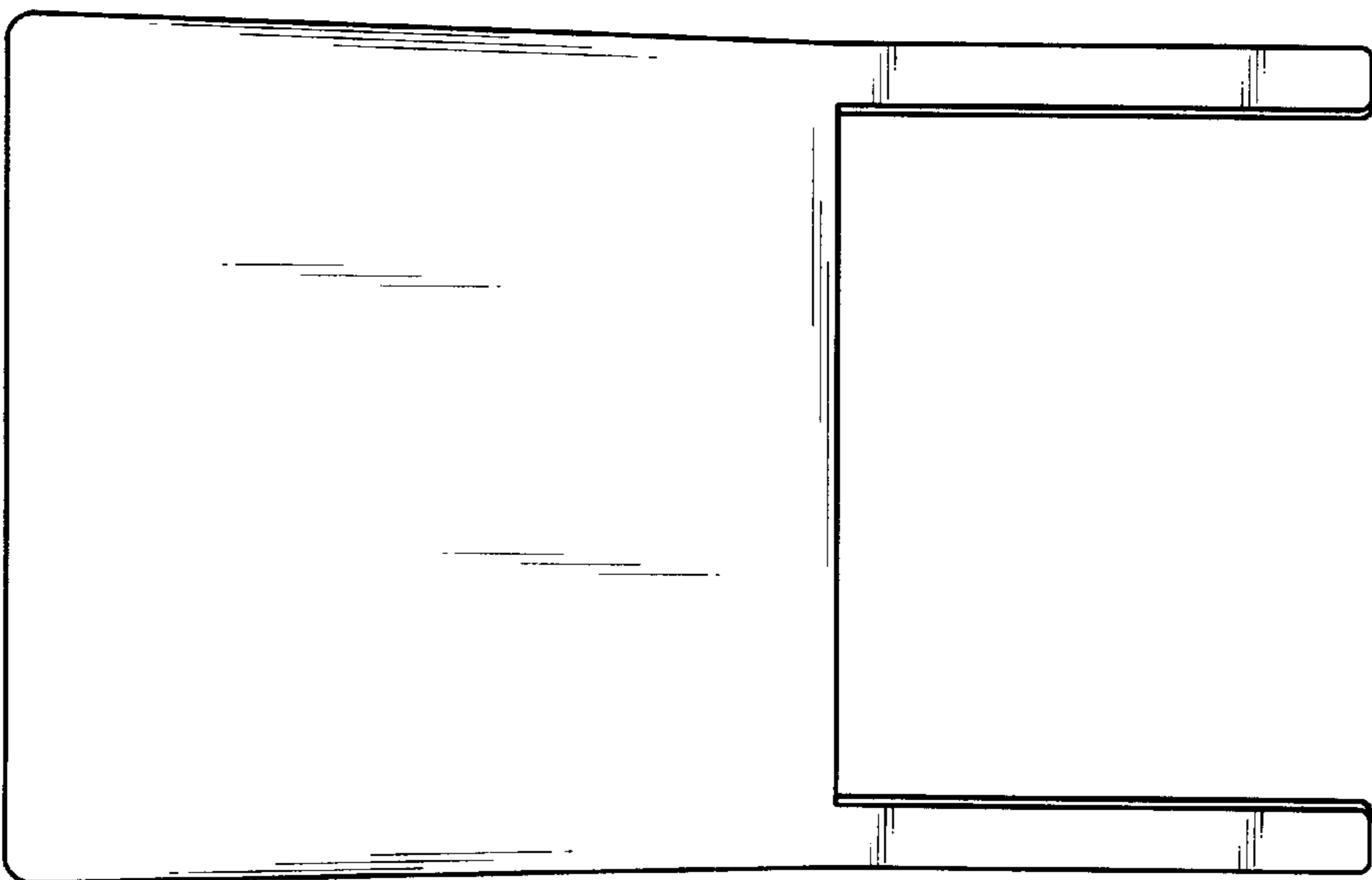

FIG. 4

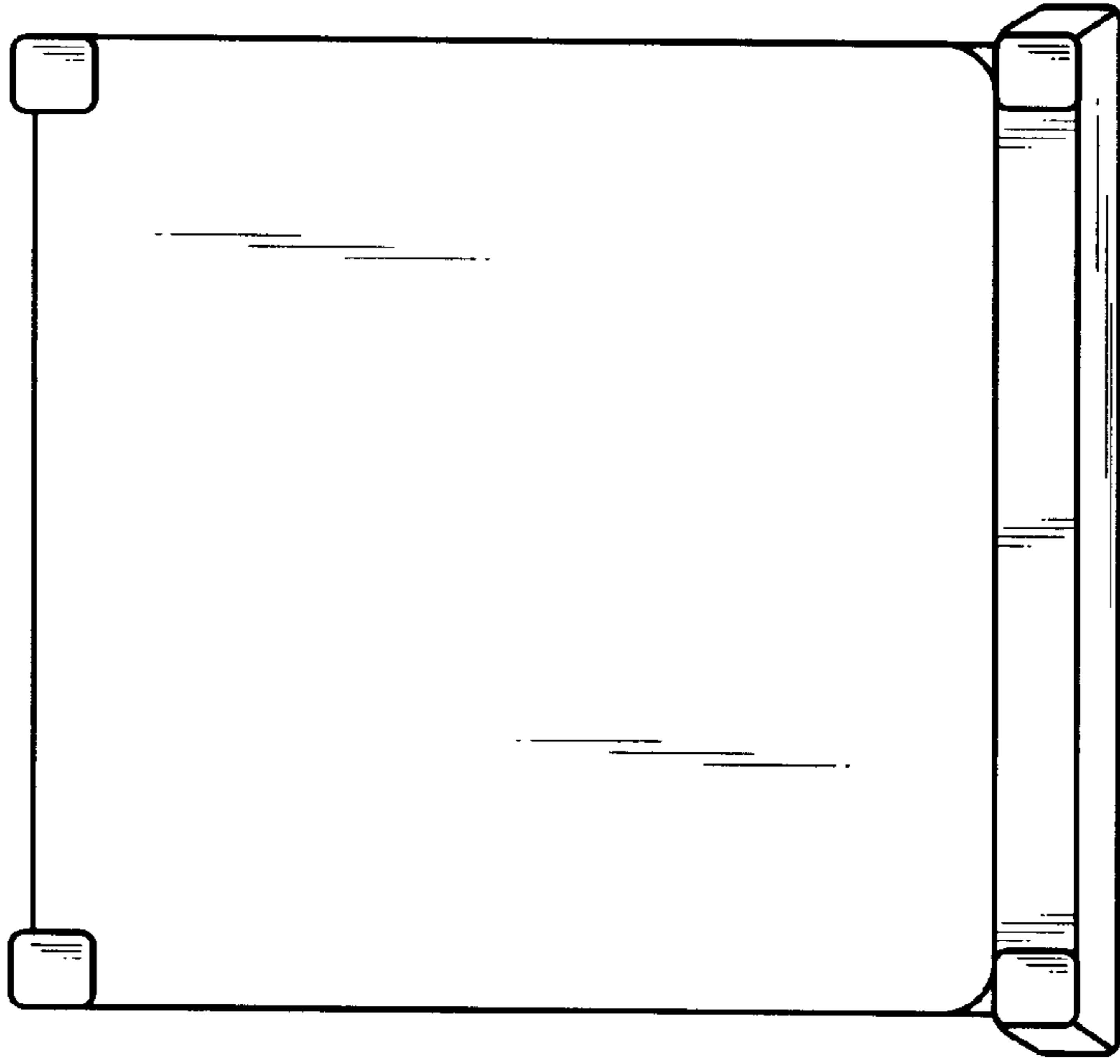

FIG. 6

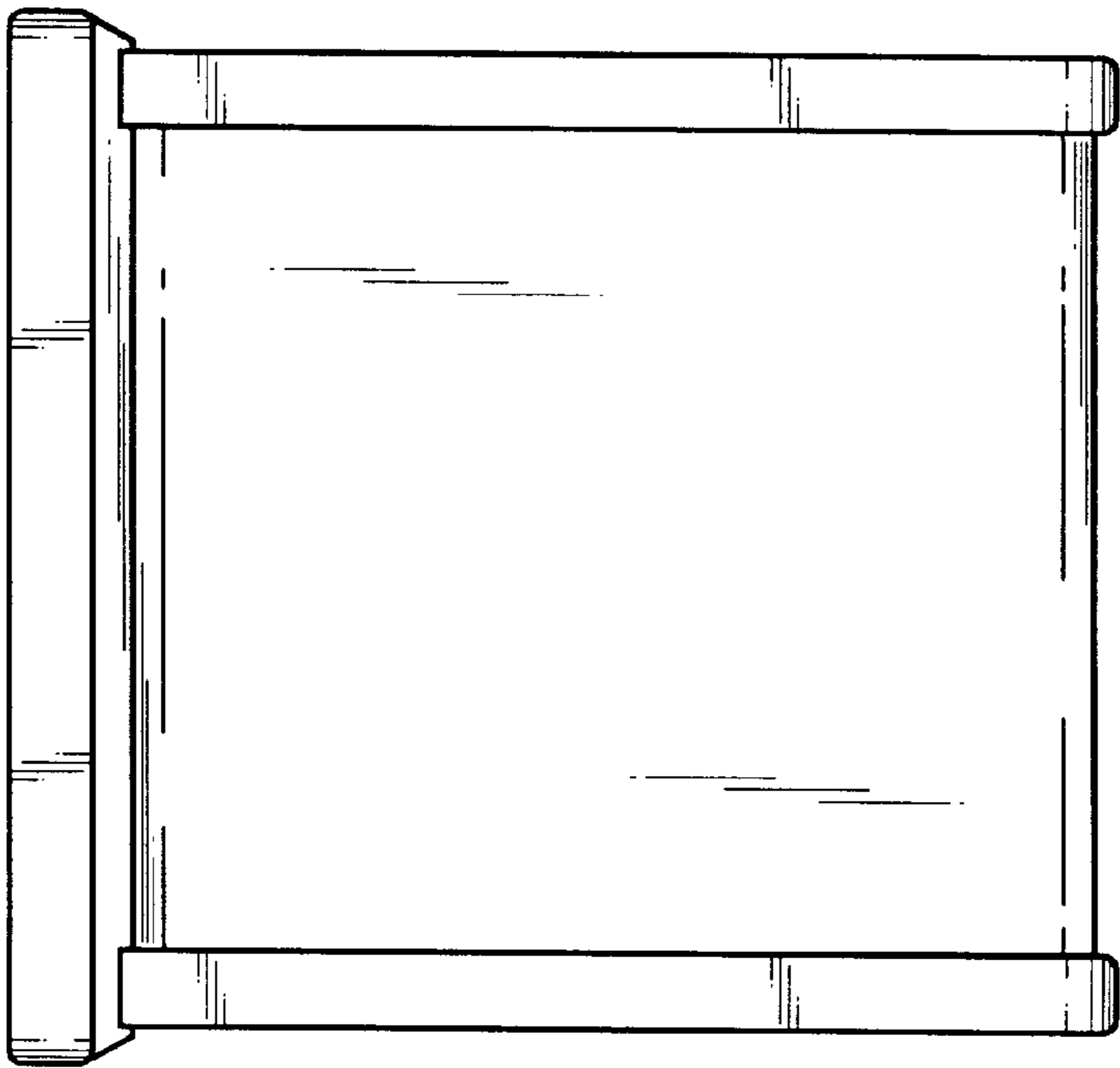

FIG. 5