



US00D430981S

United States Patent [19]

Walls, Jr.

[11] Patent Number: **Des. 430,981**

[45] Date of Patent: **** *Sep. 19, 2000**

[54] **MUSICAL DISPLAY CASE AND PEDESTAL**

[76] Inventor: **John L. Walls, Jr.**, 4702 Kemble Ct., Tampa, Fla. 33624

[*] Notice: This patent is subject to a terminal disclaimer.

[**] Term: **14 Years**

[21] Appl. No.: **29/106,886**

[22] Filed: **Jun. 24, 1999**

[51] **LOC (7) Cl.** **06-04**

[52] **U.S. Cl.** **D6/470**

[58] **Field of Search** D6/396, 408, 449, D6/455, 457, 469, 470, 475; D9/413, 432; D7/615; D17/24, 99; 206/566; 211/13, 60.1, 64, 67, 68, 131, 163; 312/114, 117, 126-130, 135, 138.1, 125

[56] **References Cited**

U.S. PATENT DOCUMENTS

D. 173,247	10/1954	White	D6/457	X
D. 314,055	1/1991	Ross et al.	D17/24	X
D. 316,638	5/1991	Oldorf	D6/408	
D. 340,154	10/1993	Endelman	D6/469	X
D. 408,174	4/1999	Aspenwall	D6/470	

D. 417,093	11/1999	Fan	D6/470	
3,931,894	1/1976	Murphy	211/163	X
5,168,985	12/1992	Shih	206/566	X

OTHER PUBLICATIONS

Studio Specialties Ltd. Catalog, Rectangular Acrylic Mirror Pedestal, Mar. 1987.

Display Innovations in Acrylic, Clear Cube Display, p. 4, 1987.

Primary Examiner—Cathron B. Matta
Attorney, Agent, or Firm—Pettis & Van Royen, P.A.

[57] **CLAIM**

The ornamental design for a musical display case and pedestal, as shown and described.

DESCRIPTION

FIG. 1 is a perspective view of the musical display case and pedestal showing my new design;
FIG. 2 is a front elevational view thereof;
FIG. 3 is a rear elevational view thereof;
FIG. 4 is a side elevational view thereof, both sides being identical;
FIG. 5 is a top plan view thereof; and,
FIG. 6 is bottom plan view thereof.

1 Claim, 2 Drawing Sheets

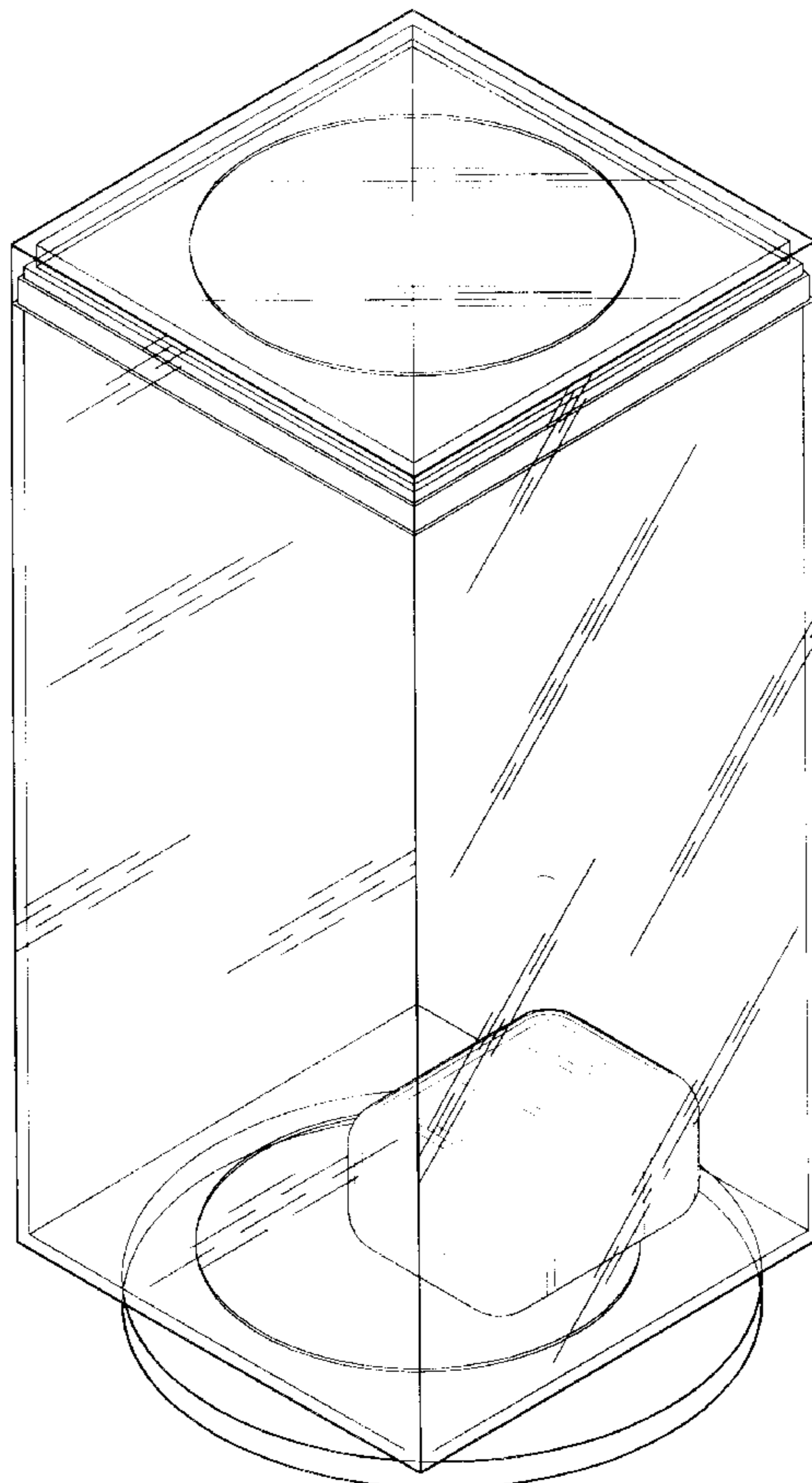

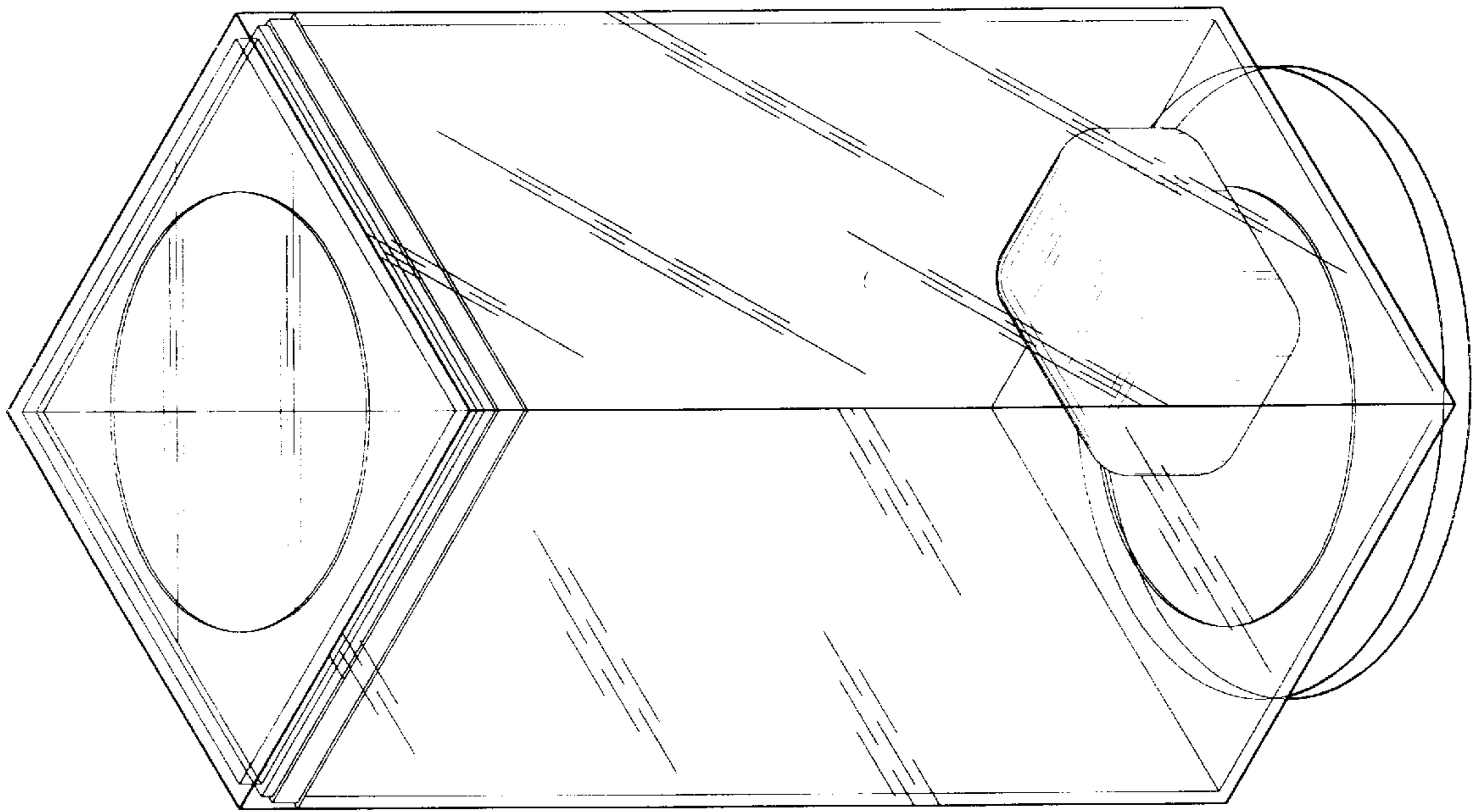

FIG. 1

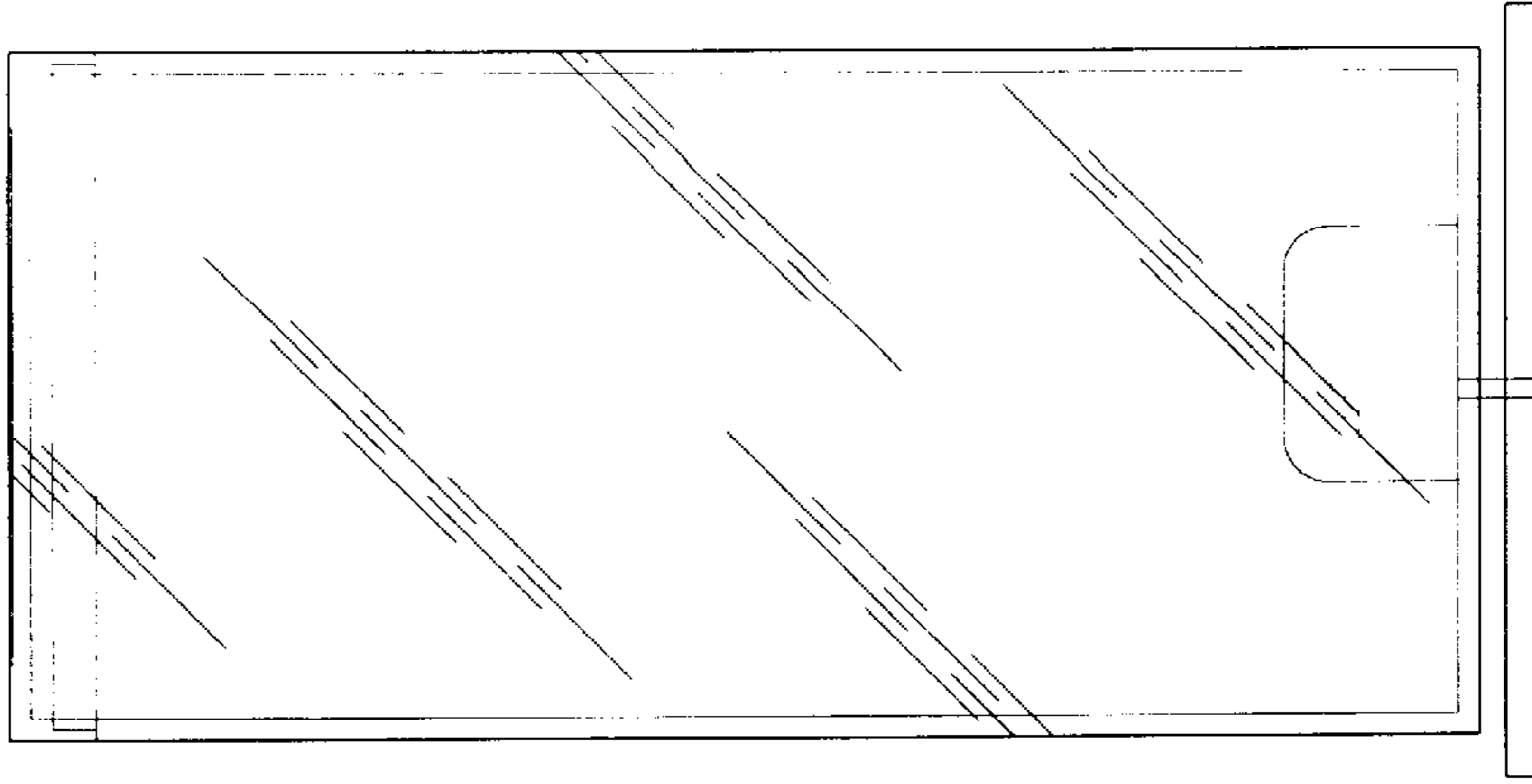

FIG. 2

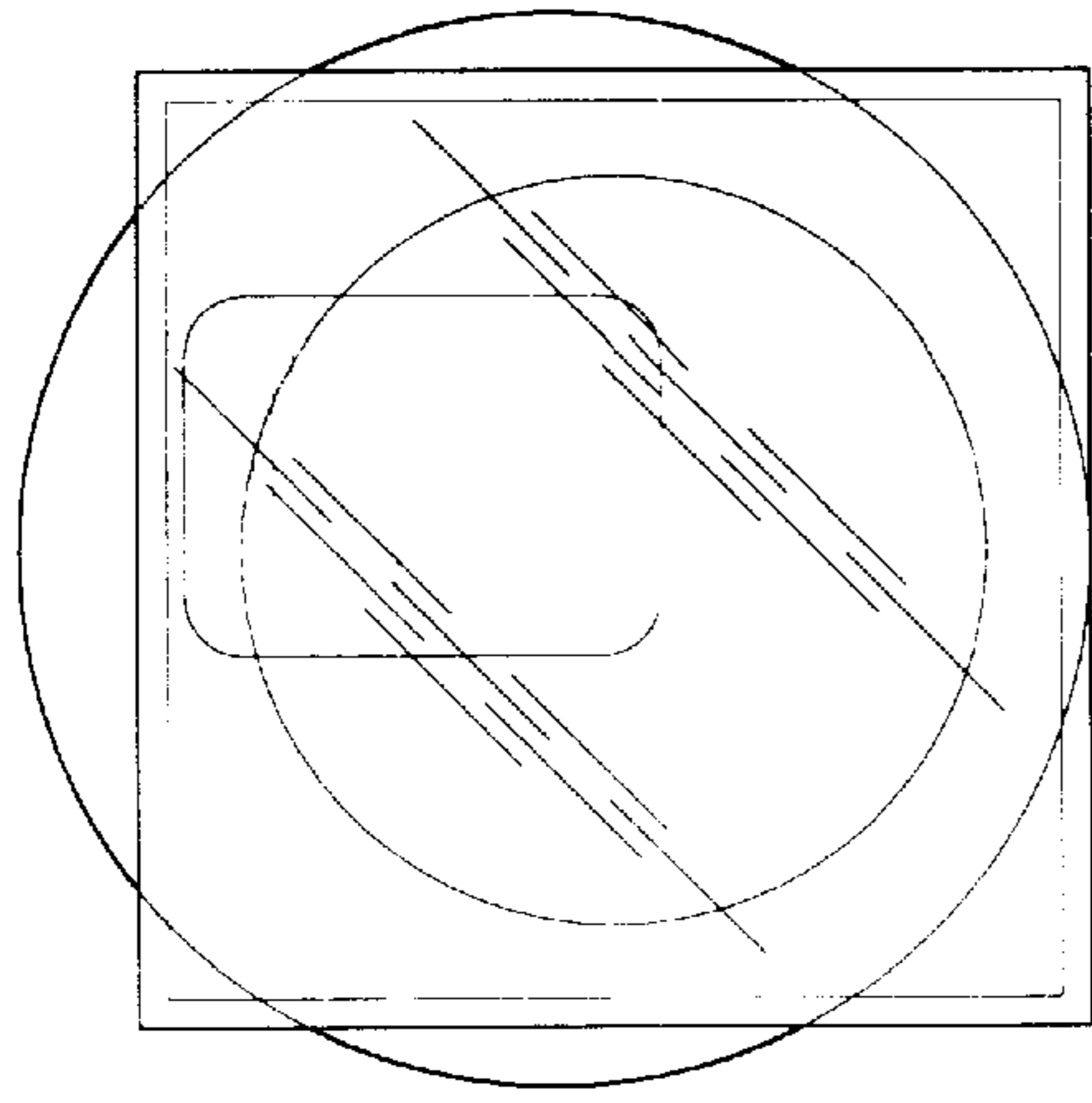

FIG. 5

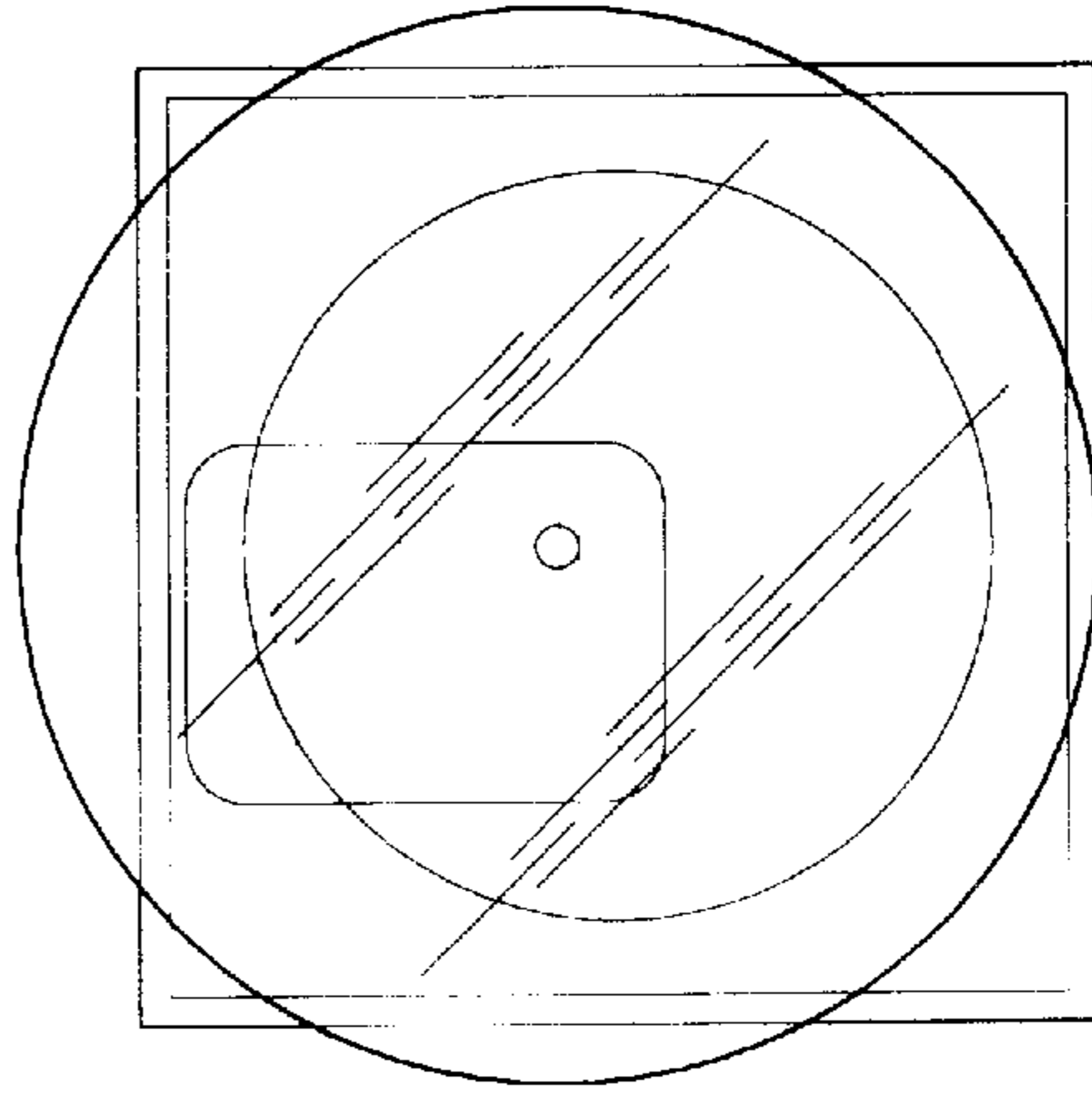

FIG. 6

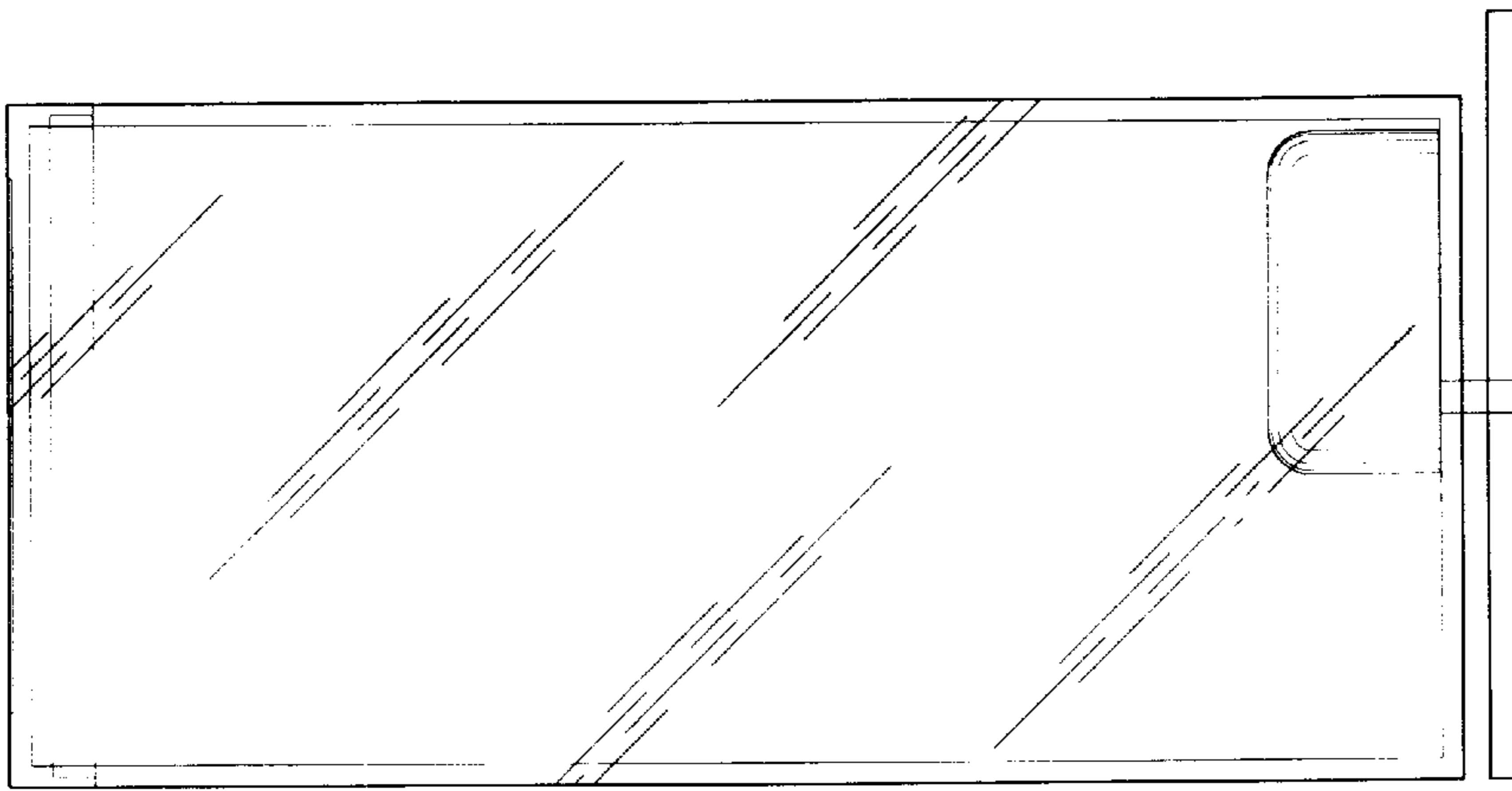

FIG. 4

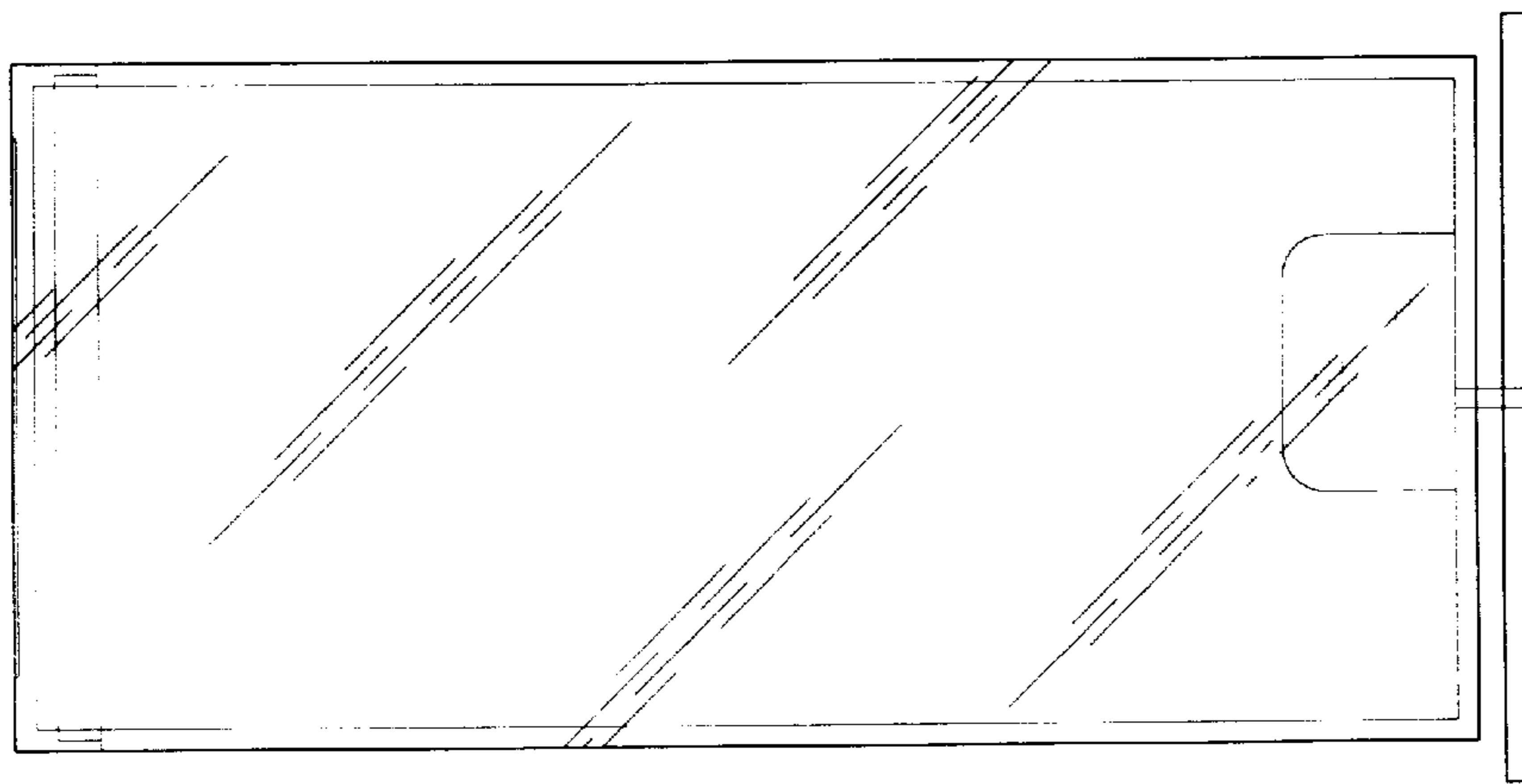

FIG. 3