



US00D430978S

# United States Patent [19]

[11] **Patent Number: Des. 430,978**

**Natuzzi et al.**

[45] **Date of Patent: \*\* Sep. 19, 2000**

[54] **SEAT**

[75] Inventors: **Pasquale Natuzzi, Bari; Cosimo Suma, Matera, both of Italy**

[73] Assignee: **Industrie Natuzzi, SpA, Bari, Italy**

[\*\*] Term: **14 Years**

[21] Appl. No.: **29/110,566**

[22] Filed: **Sep. 9, 1999**

[51] **LOC (7) Cl. .... 06-01**

[52] **U.S. Cl. .... D6/381; D6/334**

[58] **Field of Search .... D6/334, 335, 364, D6/371, 373, 381, 500, 501, 502; 297/232; 5/12.1**

## [56] **References Cited**

### U.S. PATENT DOCUMENTS

|            |        |                     |        |
|------------|--------|---------------------|--------|
| D. 362,128 | 9/1995 | Natuzzi et al. .... | D6/381 |
| D. 362,355 | 9/1995 | Natuzzi et al. .... | D6/381 |
| D. 369,480 | 5/1996 | Natuzzi et al. .... | D6/381 |
| D. 373,484 | 9/1996 | Natuzzi et al. .... | D6/381 |
| D. 384,219 | 9/1997 | Natuzzi et al. .... | D6/381 |
| D. 390,373 | 2/1998 | Natuzzi et al. .... | D6/381 |

### OTHER PUBLICATIONS

Natuzzi Model Siena, Apr. 1986, at International Home Furnishings Market in High Point, North Carolina.  
 Natuzzi Model 154, Nov. 1986, at International Home Furnishings Market in High Point, North Carolina.  
 Natuzzi Model 161, at least as early as 1986, at International Home Furnishings Market in High Point, North Carolina.  
 Natuzzi Model 411, Oct. 1987, at International Home Furnishings Market in High Point, North Carolina.  
 Natuzzi Model 419, Oct. 1987, at International Home Furnishings Market in High Point, North Carolina.  
 Natuzzi Model 425, Apr. 1988, at International Home Furnishings Market in High Point, North Carolina.  
 Natuzzi Model 434, Apr. 1988, at International Home Furnishings Market in High Point, North Carolina.  
 Natuzzi Model 476, Nov. 1988, at International Home Furnishings Market in High Point, North Carolina.

Natuzzi Model 854, Apr. 1991, at International Home Furnishings Market in High Point, North Carolina.  
 Natuzzi Model 863, Oct. 1991, at International Home Furnishings Market in High Point, North Carolina.  
 Natuzzi Model 934, Apr. 1992, at International Home Furnishings Market in High Point, North Carolina.  
 Natuzzi Model 964, Sep. 1992, at International Home Furnishings Market in High Point, North Carolina.  
 Natuzzi Model 970, Oct. 1992, at International Home Furnishings Market in High Point, North Carolina.  
 Natuzzi Model 1089, Sep. 1993, at International Home Furnishings Market in High Point, North Carolina.  
 Natuzzi Model 1150, Apr. 1994, at International Home Furnishings Market in High Point, North Carolina.  
 Natuzzi Model 1173, Apr. 1994, at International Home Furnishings Market in High Point, North Carolina.

(List continued on next page.)

*Primary Examiner*—Gary D. Watson  
*Attorney, Agent, or Firm*—Alston & Bird LLP

## [57] **CLAIM**

The ornamental design for a seat, as shown and described.

### **DESCRIPTION**

FIG. 1 is a front perspective view of a seat showing our new design in the form of a sofa;  
 FIG. 2 is a front elevational view thereof;  
 FIG. 3 is a top plan view thereof;  
 FIG. 4 is a right side elevational view, the left side being a mirror image thereof;  
 FIG. 5 is a rear perspective view thereof;  
 FIG. 6 is a front elevational view of a seat showing our new design in the form of a loveseat; and,  
 FIG. 7 is a front elevational view of a seat showing our new design in the form of a chair.  
 The broken lines shown herein are for illustrative purposes only and form no part of the claimed design.  
 The rear views of FIGS. 6 and 7 are like FIG. 5, the difference being a matter of length.  
 The end views of FIGS. 6 and 7 are like FIG. 4.  
 FIGS. 1 and 5 are shown on an enlarged scale with respect to the other views.

**1 Claim, 3 Drawing Sheets**

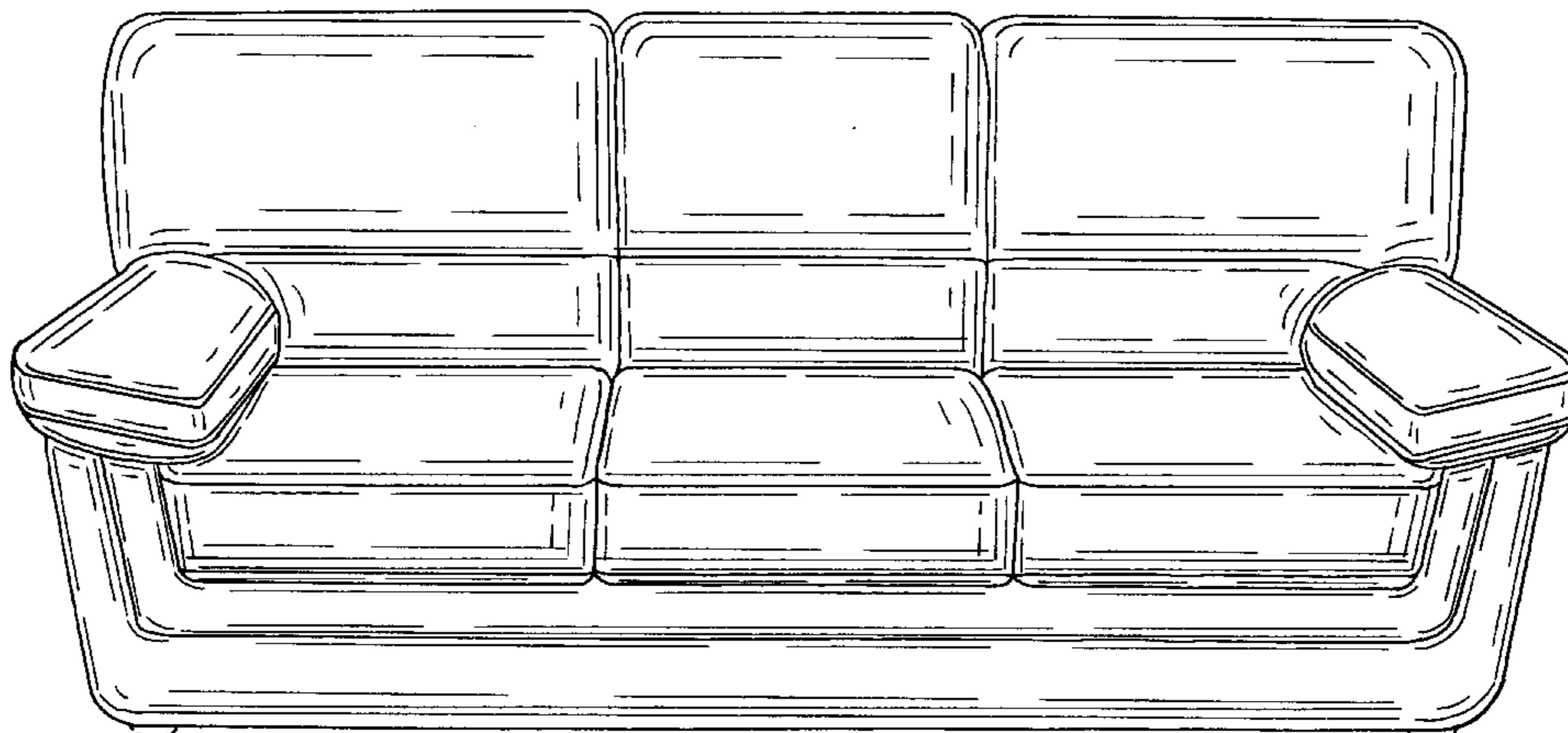

OTHER PUBLICATIONS

Natuzzi Model 1182, Apr. 1994, at International Home Furnishings Market in High Point, North Carolina.

Natuzzi Model 1245, Oct. 1994, at International Home Furnishings Market in High Point, North Carolina.

Natuzzi Model 1343, Sep. 1995, at International Home Furnishings Market in High Point, North Carolina.

Natuzzi Model 1386, Oct. 1995, at International Home Furnishings Market in High Point, North Carolina.

Natuzzi Model 1450, Mar. 1996, at International Home Furnishings Market in High Point, North Carolina.

Natuzzi Model 1483, Oct. 1996, at International Home Furnishings Market in High Point, North Carolina.

Natuzzi Model 1692, Apr. 1998, at International Home Furnishings Market in High Point, North Carolina.

Natuzzi Model 1698, Apr. 1998, at International Home Furnishings Market in High Point, North Carolina.

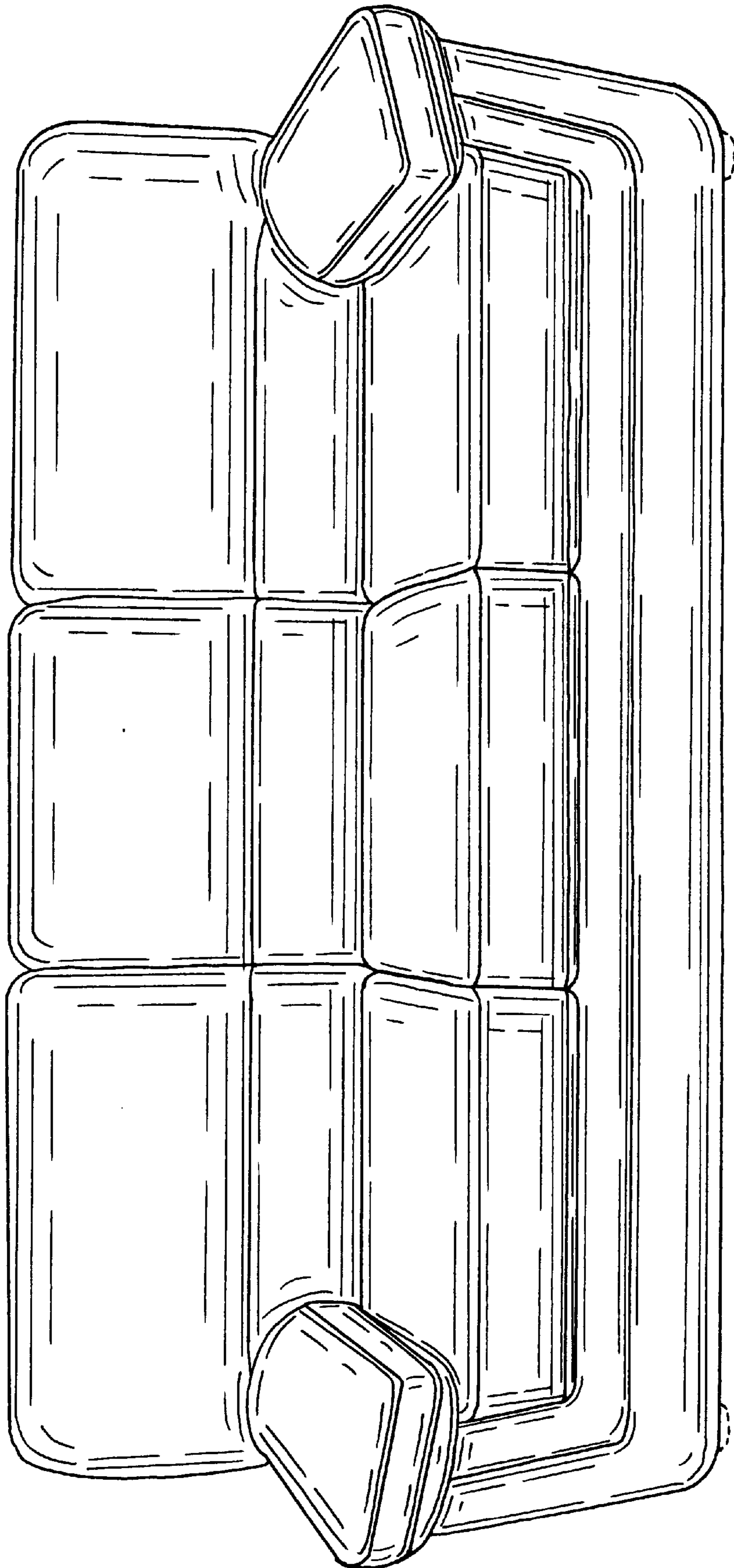

FIG. 1.



FIG. 2.

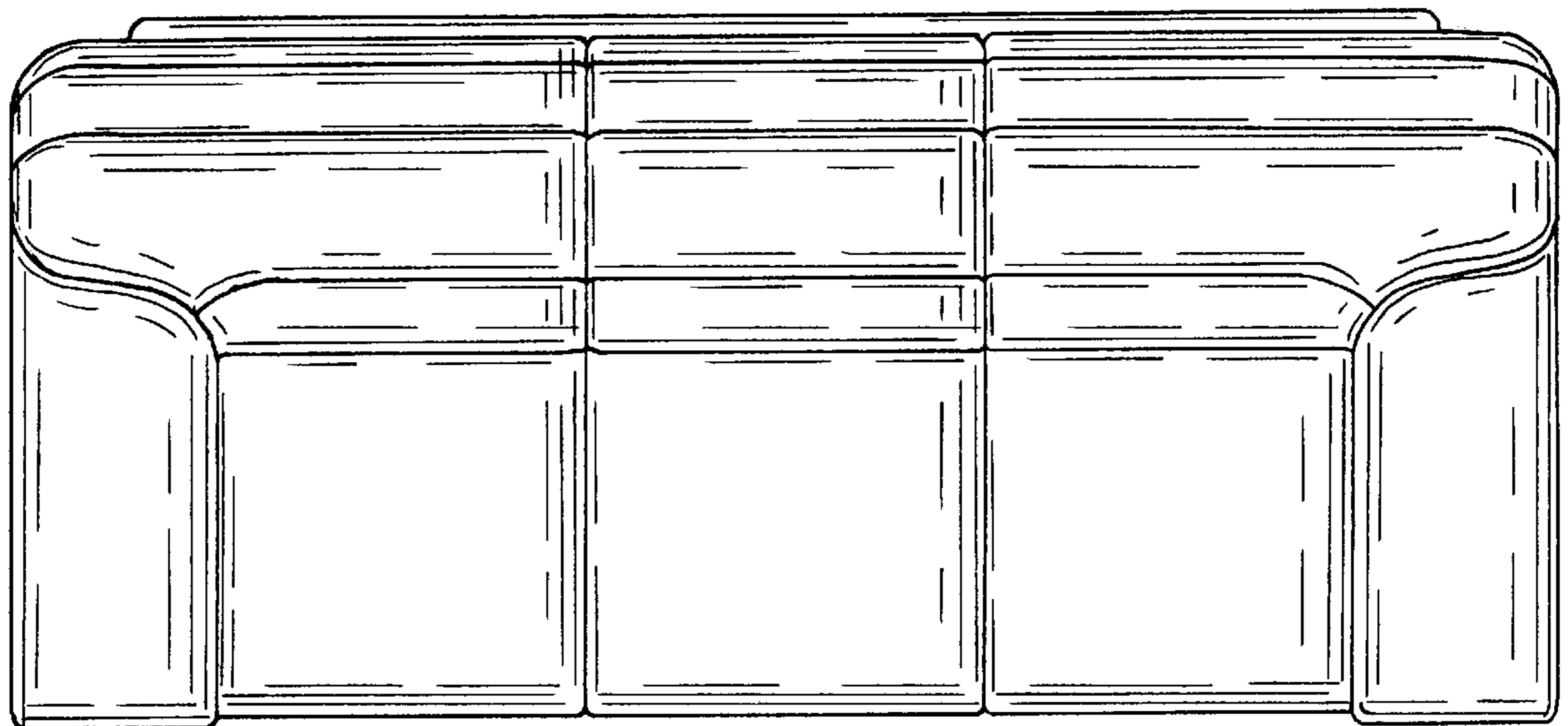

FIG. 3.

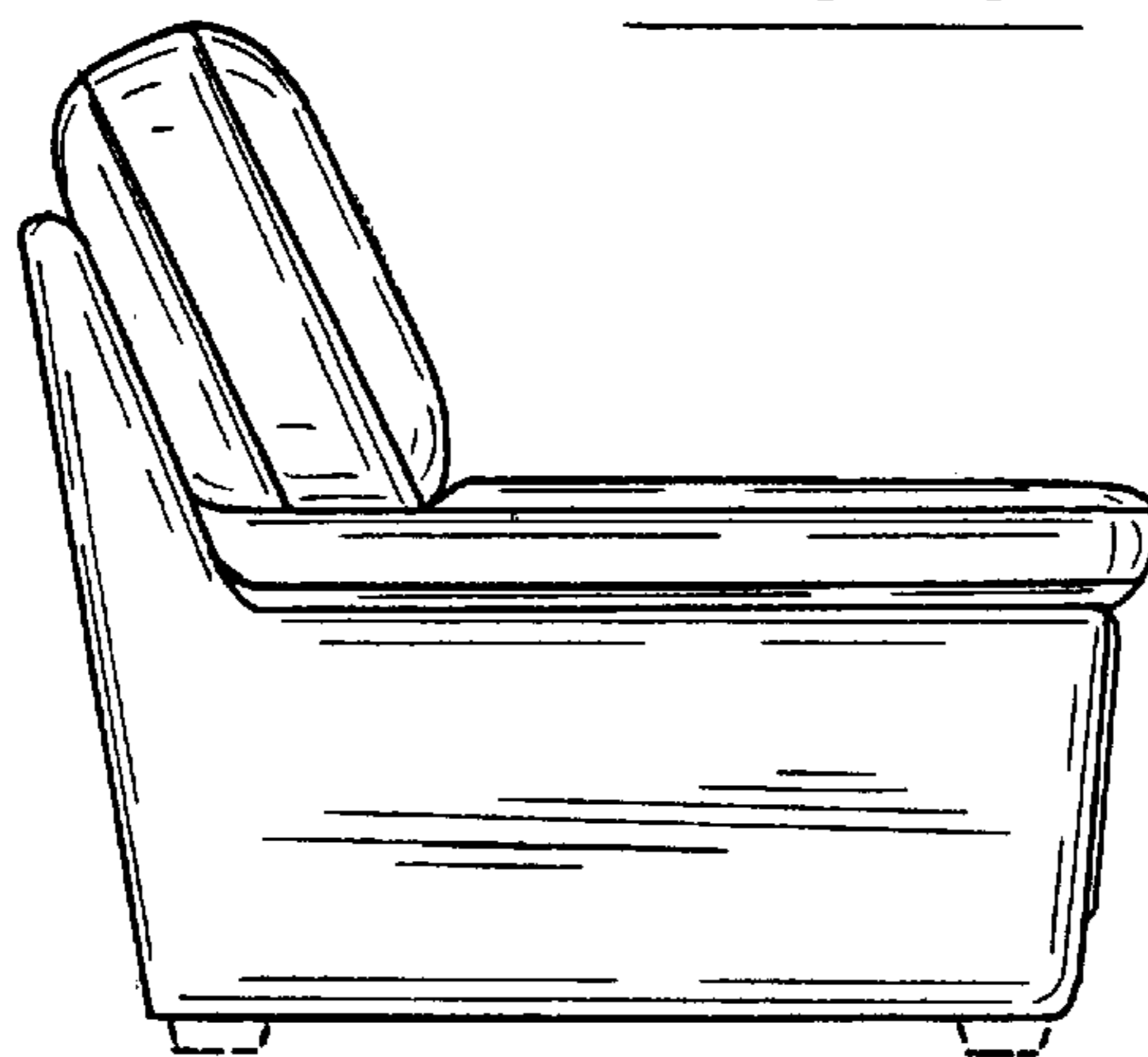

FIG. 4.



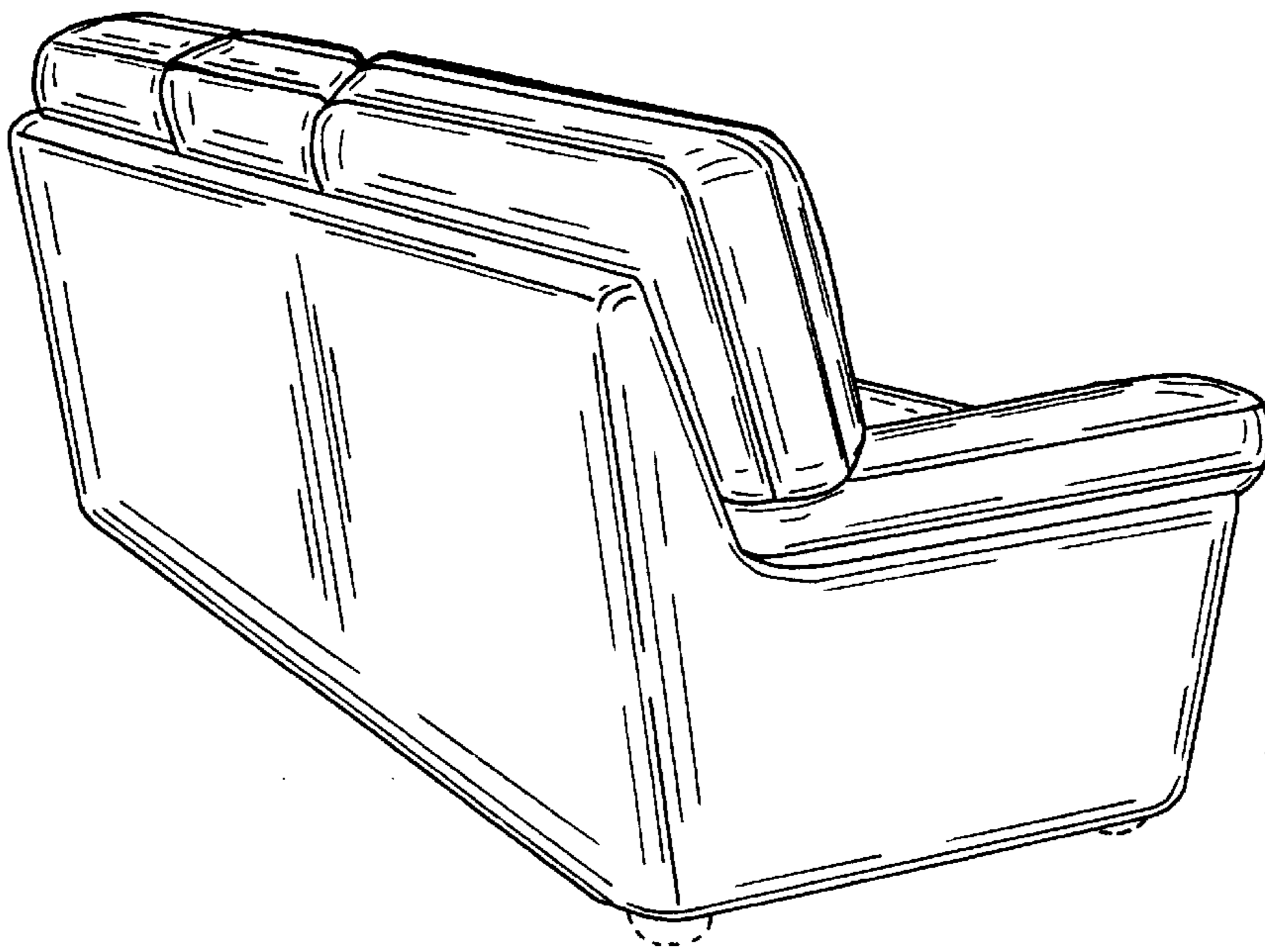

FIG. 5.

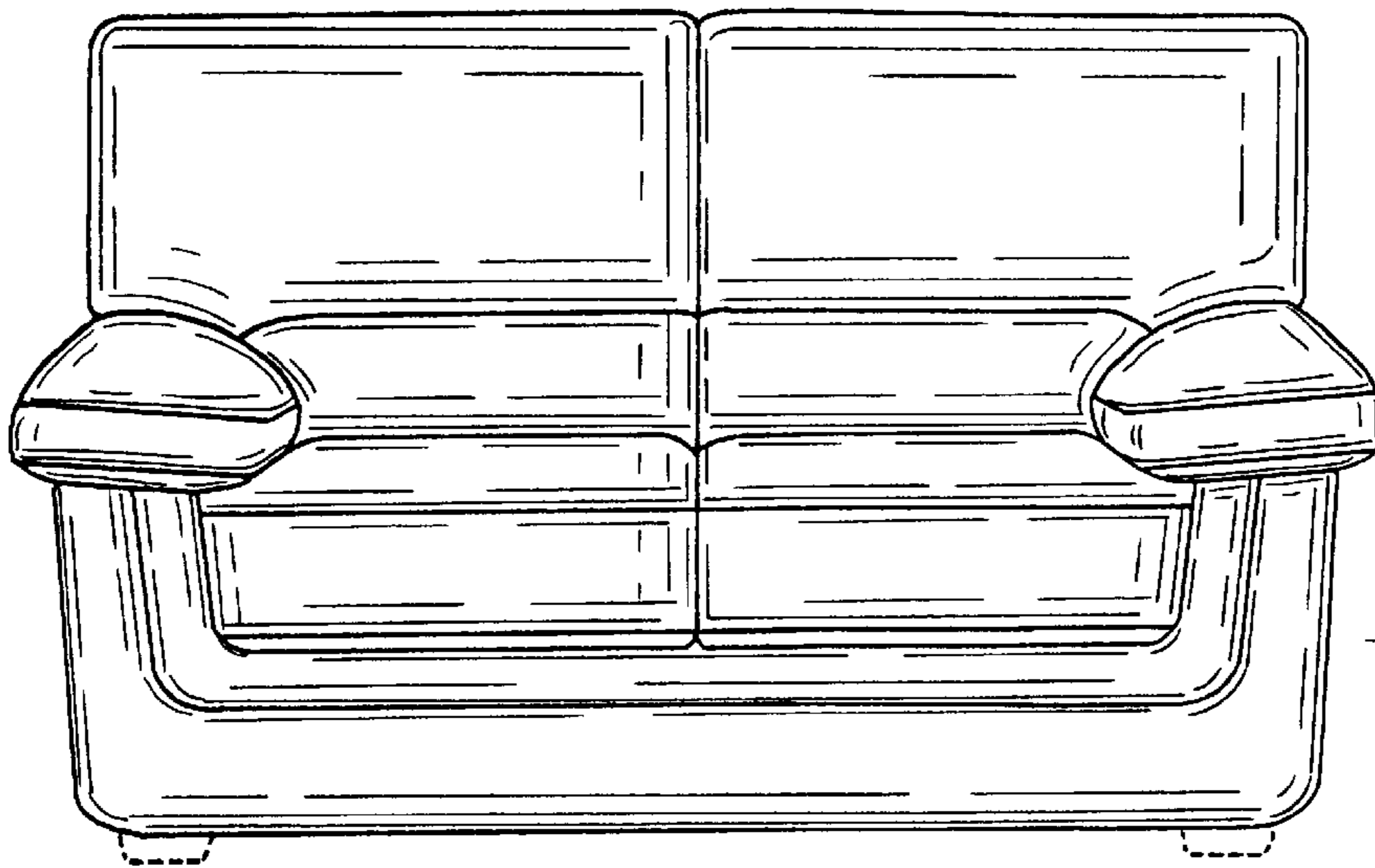

FIG. 6.

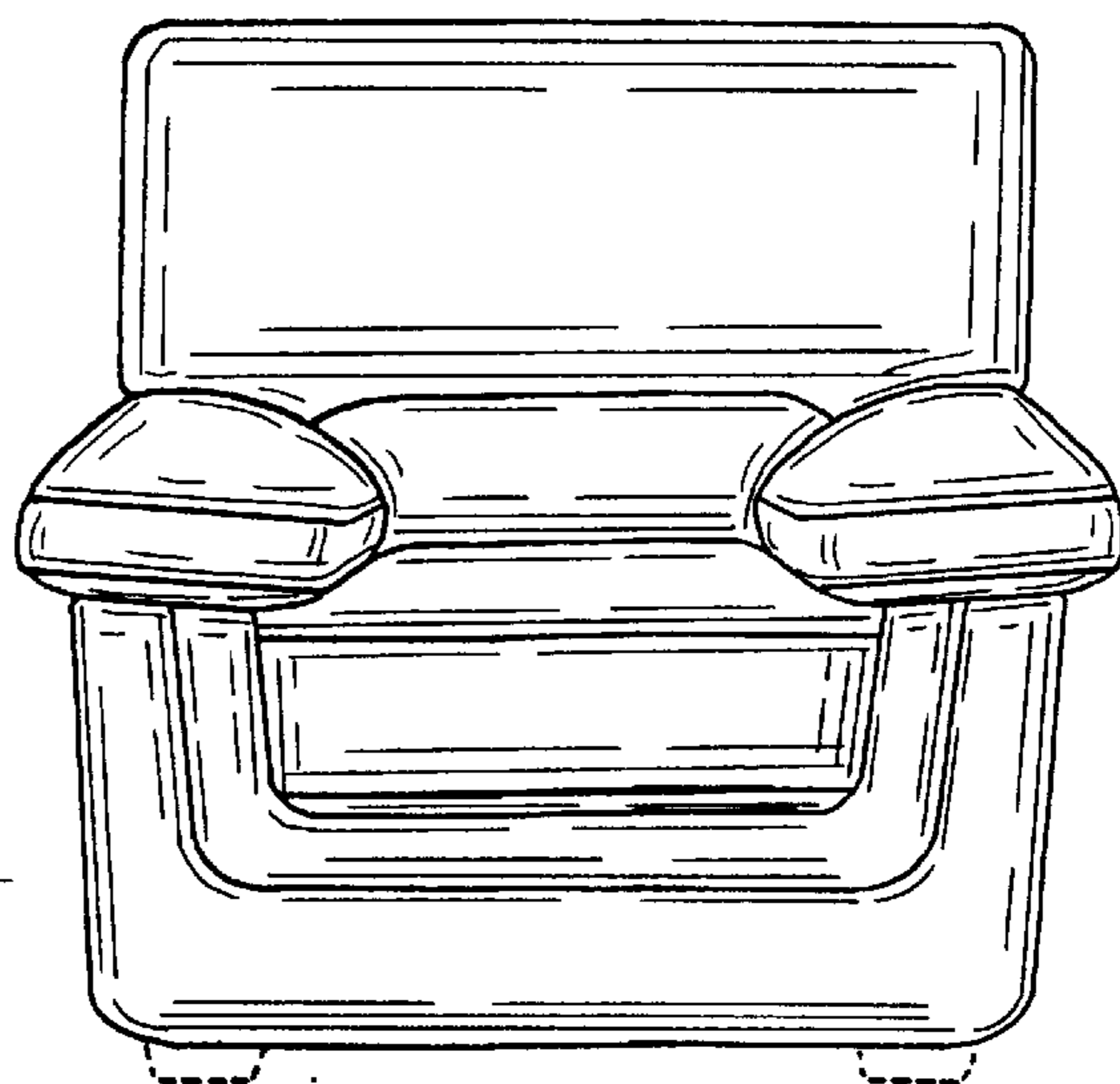

FIG. 7.