



US00D430968S

United States Patent [19] Carroll

[11] Patent Number: Des. 430,968

[45] Date of Patent: ** Sep. 19, 2000

[54] **GOLF SHOE SPIKE**

[75] Inventor: **Francis C. Carroll**, Philadelphia, Pa.

[73] Assignee: **Green Keepers, Inc.**, Warminster, Pa.

[**] Term: **14 Years**

[21] Appl. No.: **29/103,173**

[22] Filed: **Jan. 21, 1997**

[51] **LOC (7) Cl.** **02-04**

[52] **U.S. Cl.** **D2/962**

[58] **Field of Search** D2/962, 906; 36/126-130,
36/67 A, 67 B, 67 C, 67 D, 59 R, 134,
59 C

[56] **References Cited**

U.S. PATENT DOCUMENTS

D. 371,895	7/1996	McMullin	D2/962
D. 373,675	9/1996	McMullin	.	
D. 378,013	2/1997	McMullin	.	
D. 380,076	6/1997	McMullin	.	
D. 389,299	1/1998	McMullin	D2/962
D. 395,542	6/1998	Collins	D2/962
D. 404,192	1/1999	McMullin	D2/962
D. 418,968	1/2000	Parker	D2/962
5,533,282	7/1996	Kataoka et al.	36/129
5,794,367	8/1998	Carroll	36/134

OTHER PUBLICATIONS

NIKE Holiday Catalog, p. W149, Genuine Replacement Parts, Spikes along bottom of page, Dec. 1999.

Primary Examiner—Louis S. Zarfes
Assistant Examiner—G. Andoll
Attorney, Agent, or Firm—Jim Zegeer

[57] **CLAIM**

The ornamental design for a golf shoe spike, as shown and described.

DESCRIPTION

FIG. 1 is an isometric perspective view of a golf shoe spike showing my new design installed on a golf shoe; FIG. 2 is a front view of my golf shoe spike, FIG. 3 is a side elevation view of my golf shoe spike, FIG. 4 is a back view of my golf shoe spike, FIG. 5 is a 3/4 angle isometric view of my golf shoe spike, FIG. 6 is a front view of a second embodiment, the side and back view being the same as FIGS. 3 and 4; and, FIG. 7 is a front view of a third embodiment, the side and back views being the same as FIGS. 3 and 4.

The broken line showing of the shoe in FIG. 1 is for illustrative purposes only and forms no part of the claimed design.

1 Claim, 4 Drawing Sheets

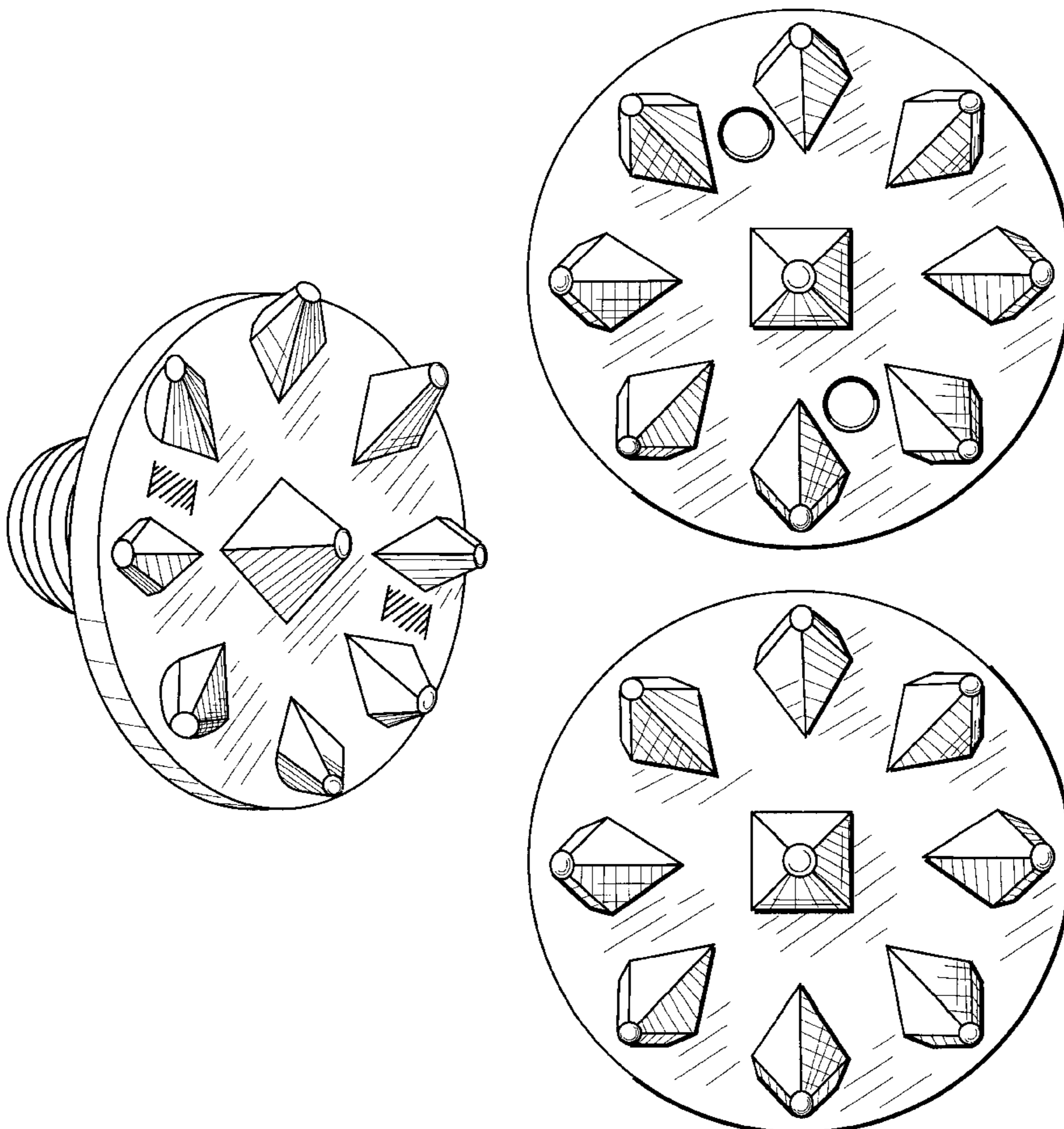

FIG. 1

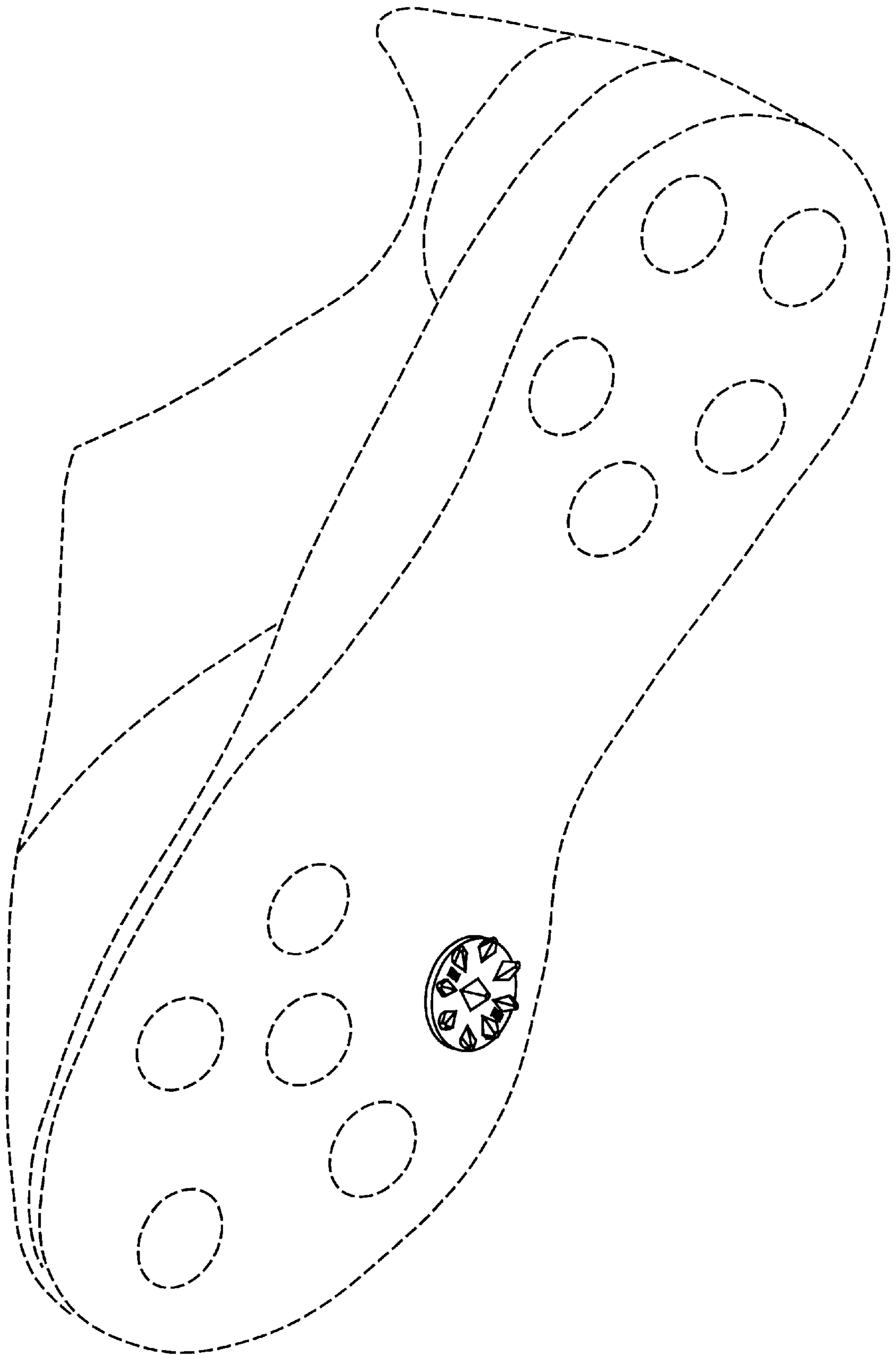

FIG. 2

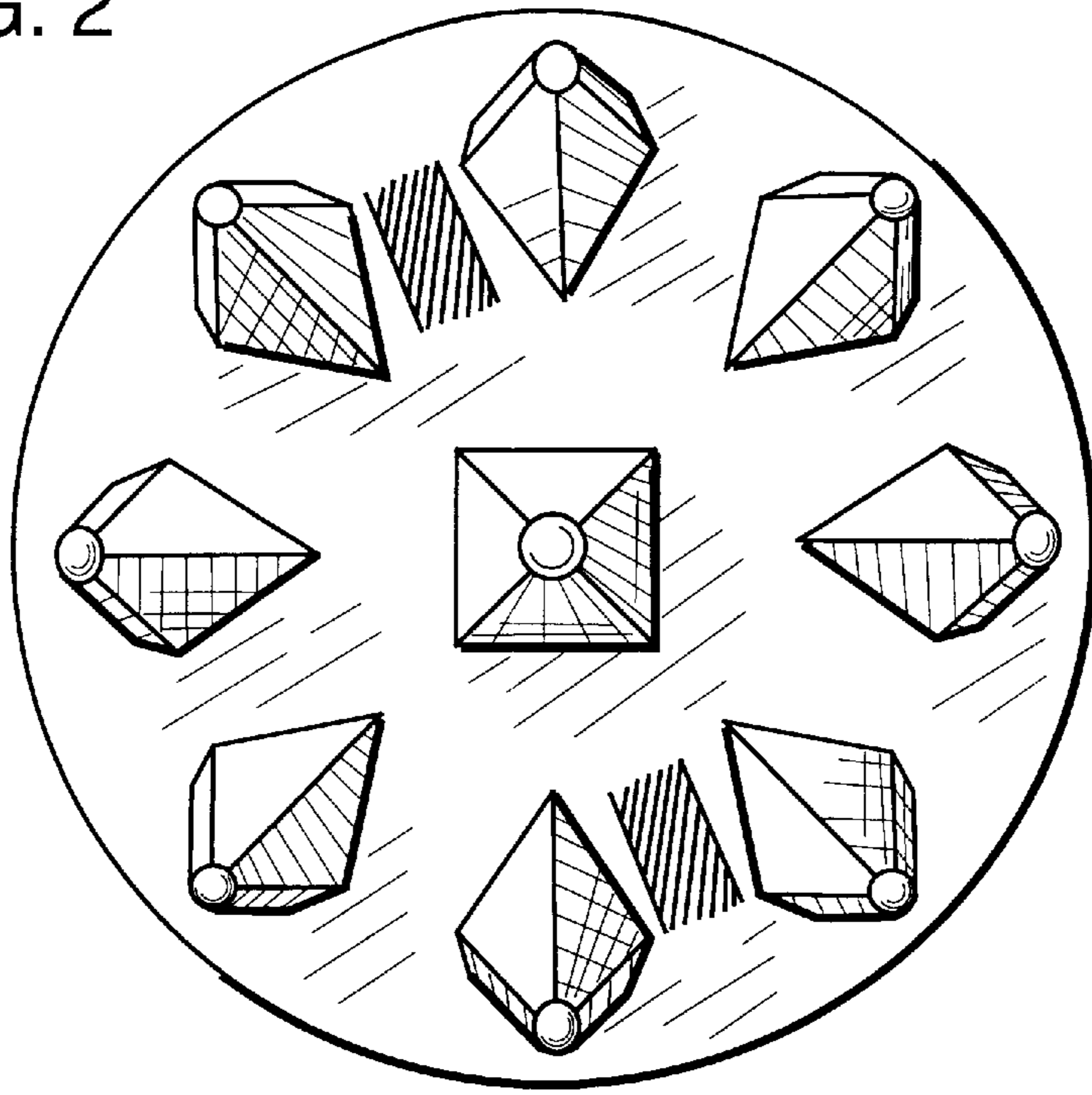

FIG. 3

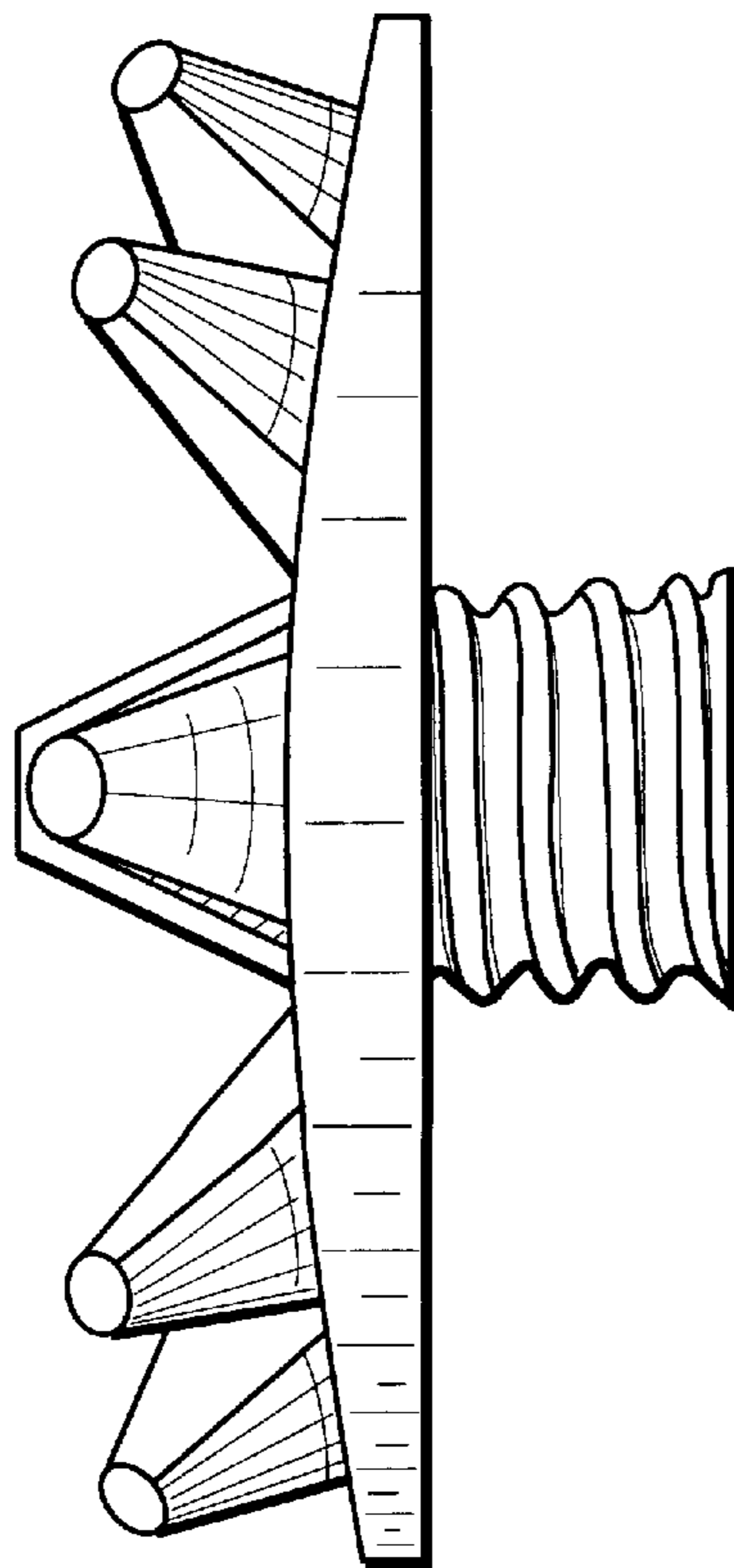

FIG. 4

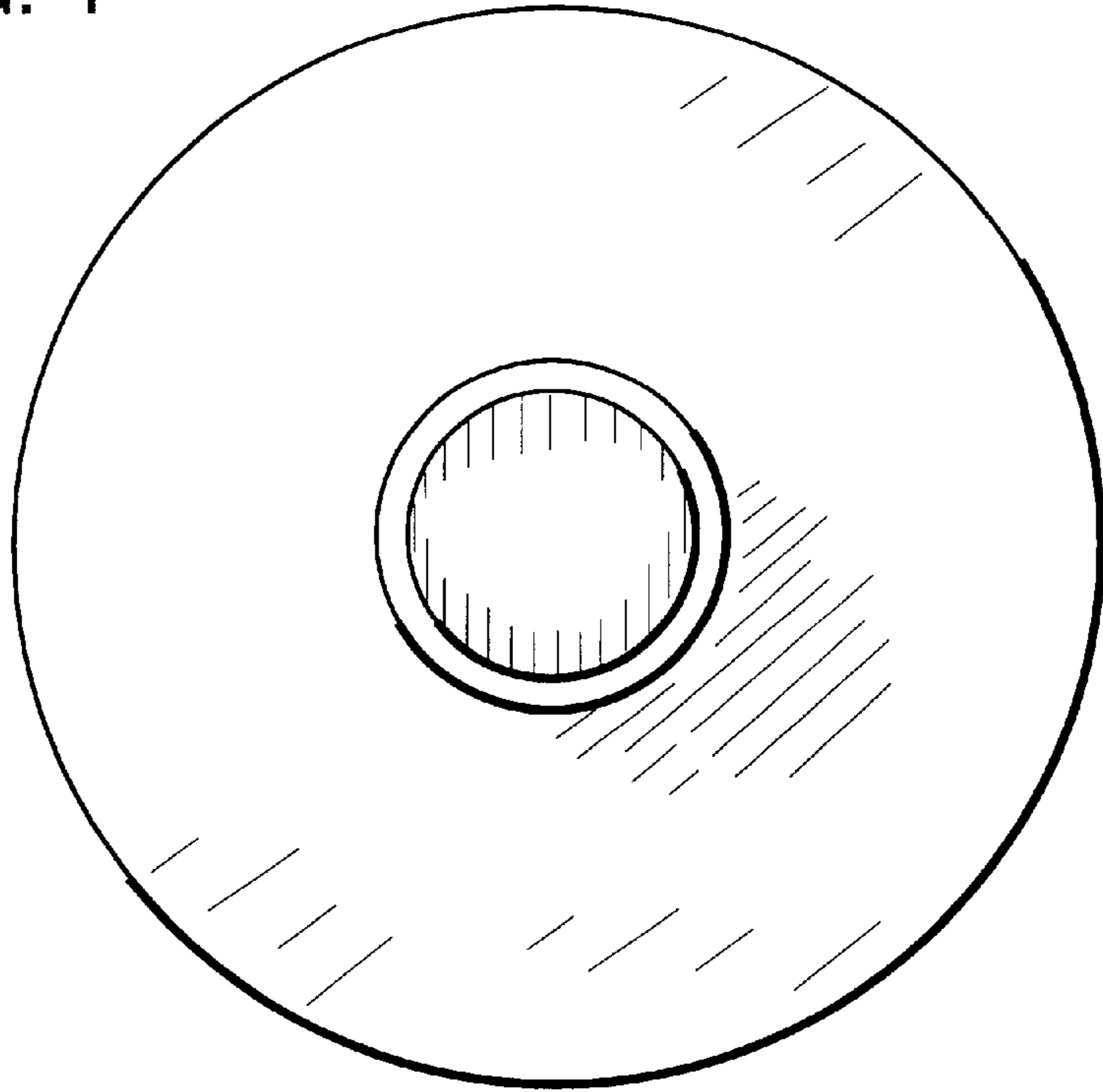

FIG. 5

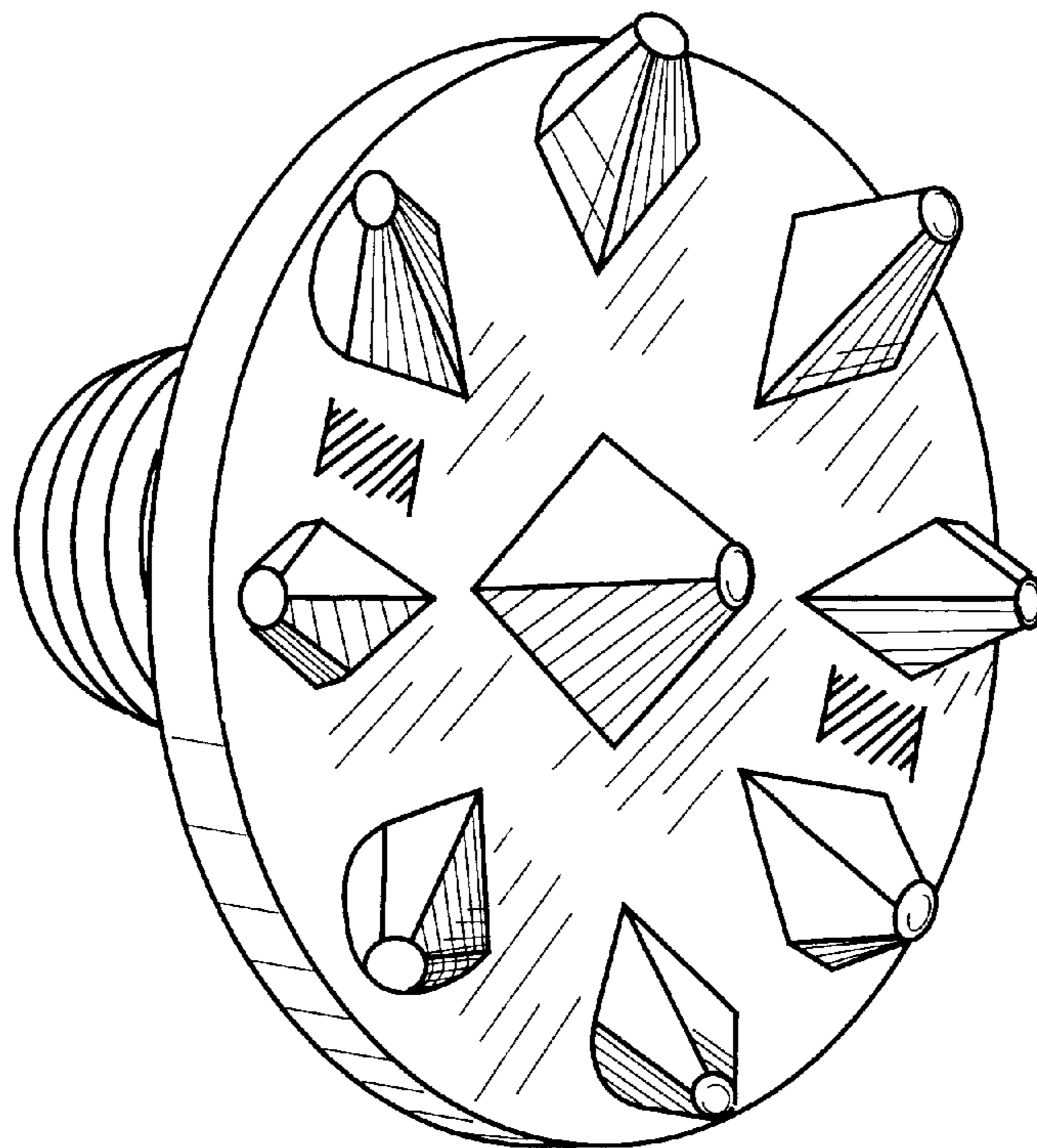

FIG. 6

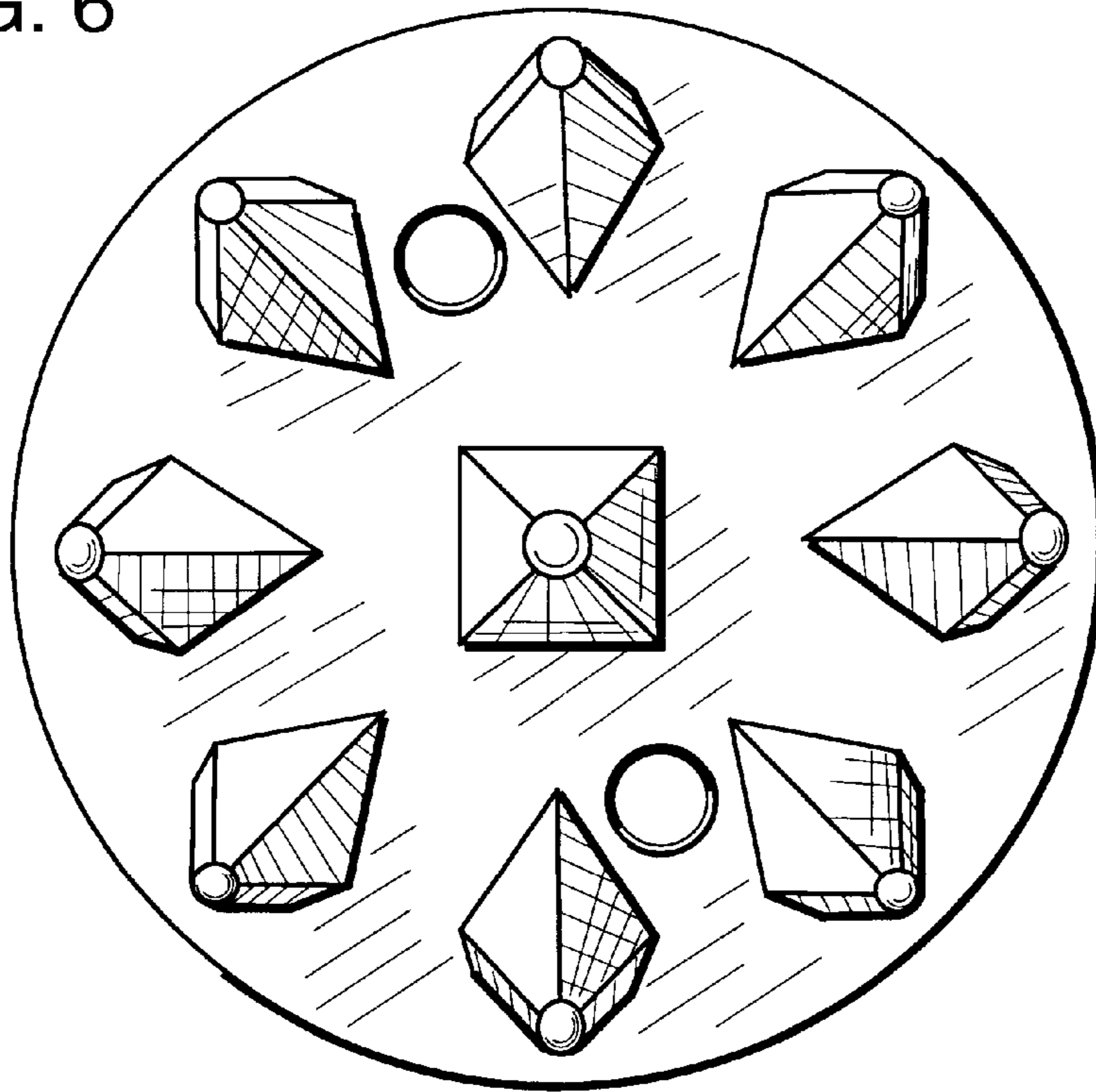

FIG. 7

