



US00D430895S

# United States Patent [19]

Inoue

[11] Patent Number: Des. 430,895

[45] Date of Patent: \*\* Sep. 12, 2000

[54] COMPUTER PRINTER CAPABLE OF SERVING AS PHOTOCOPIER

[75] Inventor: Manabu Inoue, Yokohama, Japan

[73] Assignee: Canon Kabushiki Kaisha, Tokyo, Japan

[\*\*] Term: 14 Years

[21] Appl. No.: 29/102,889

[22] Filed: Apr. 1, 1999

### [30] Foreign Application Priority Data

Oct. 5, 1998 [JP] Japan ..... 10-28548

[51] LOC (7) Cl. .... 14-02

[52] U.S. Cl. .... D18/54; D18/39

[58] Field of Search ..... D18/36-39, 50, D18/54-55; 400/613, 613.1-613.4, 691-694, 690.1-690.4

### [56] References Cited

#### U.S. PATENT DOCUMENTS

- D. 295,853 5/1988 Ooie ..... D18/55
- D. 339,151 9/1993 Ratzlaff ..... D18/36
- D. 343,637 1/1994 Umino et al. .... D18/55
- D. 352,056 11/1994 Kawashima et al. .... D18/50

- D. 354,304 1/1995 Ishibashi et al. .... D18/36
- D. 370,495 6/1996 Inoue et al. .... D18/50
- D. 370,496 6/1996 Inoue et al. .... D18/50
- D. 384,969 10/1997 Inoue et al. .... D18/54
- D. 390,593 2/1998 Inoue ..... D18/54
- D. 391,929 3/1998 Inoue .
- D. 394,645 5/1998 Inoue .
- D. 398,334 9/1998 Komatsu ..... D18/36
- D. 413,351 8/1999 Escobedo et al. .... D18/50
- D. 421,045 2/2000 Quijano ..... D18/55

Primary Examiner—Cathy Anne MacCormac  
Attorney, Agent, or Firm—Fitzpatrick, Cella, Harper & Scinto

### [57] CLAIM

The ornamental design for a computer printer capable of serving as photocopier, as shown and described.

### DESCRIPTION

FIG. 1 is a front view of a computer printer capable of serving as photocopier showing my new design; FIG. 2 is a rear view thereof; FIG. 3 is a top plan view thereof; FIG. 4 is a bottom plan view thereof; FIG. 5 is a left side view thereof; FIG. 6 is a right side view thereof; and, FIG. 7 is a perspective view thereof.

1 Claim, 5 Drawing Sheets

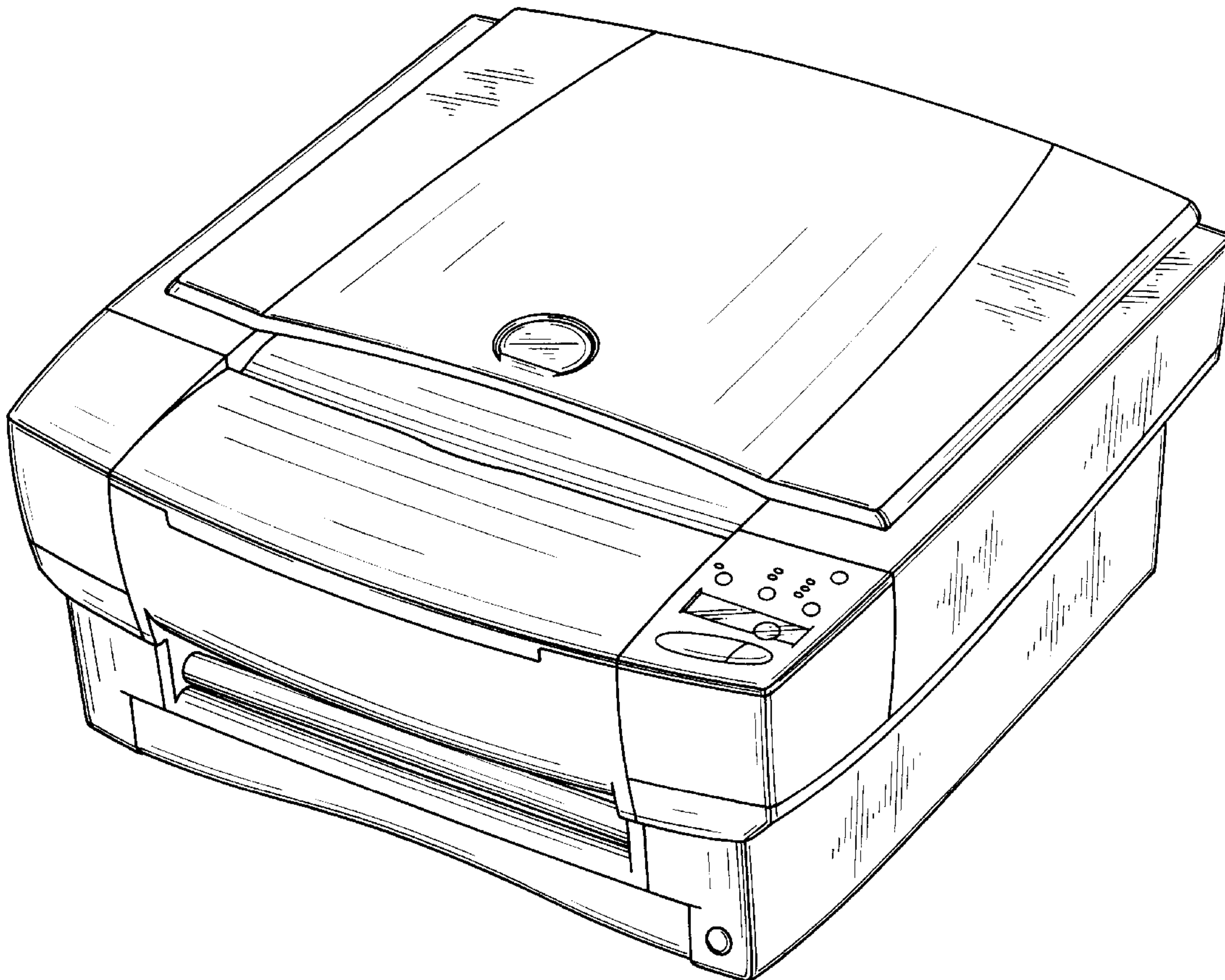

FIG. 1

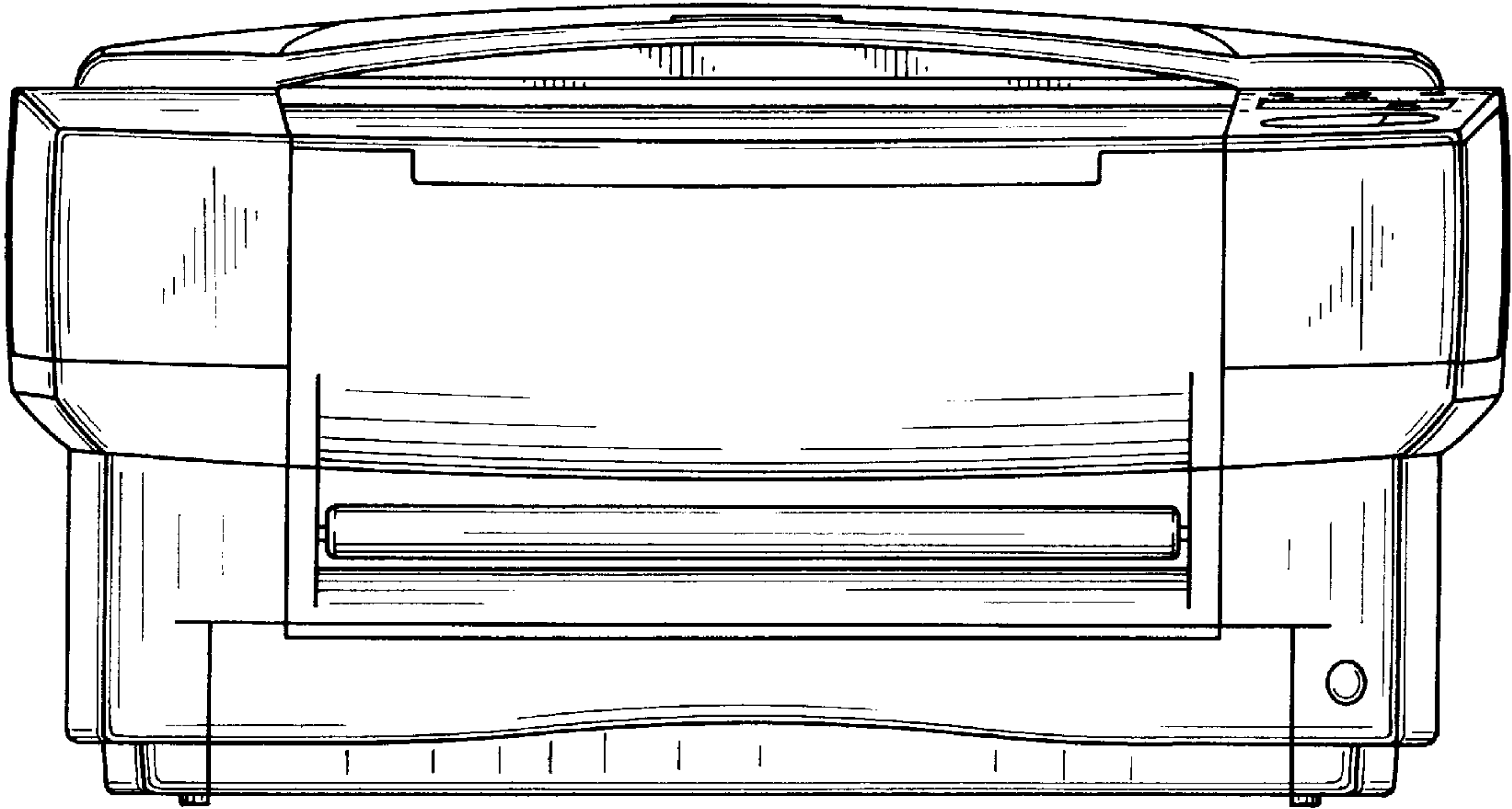

FIG. 2

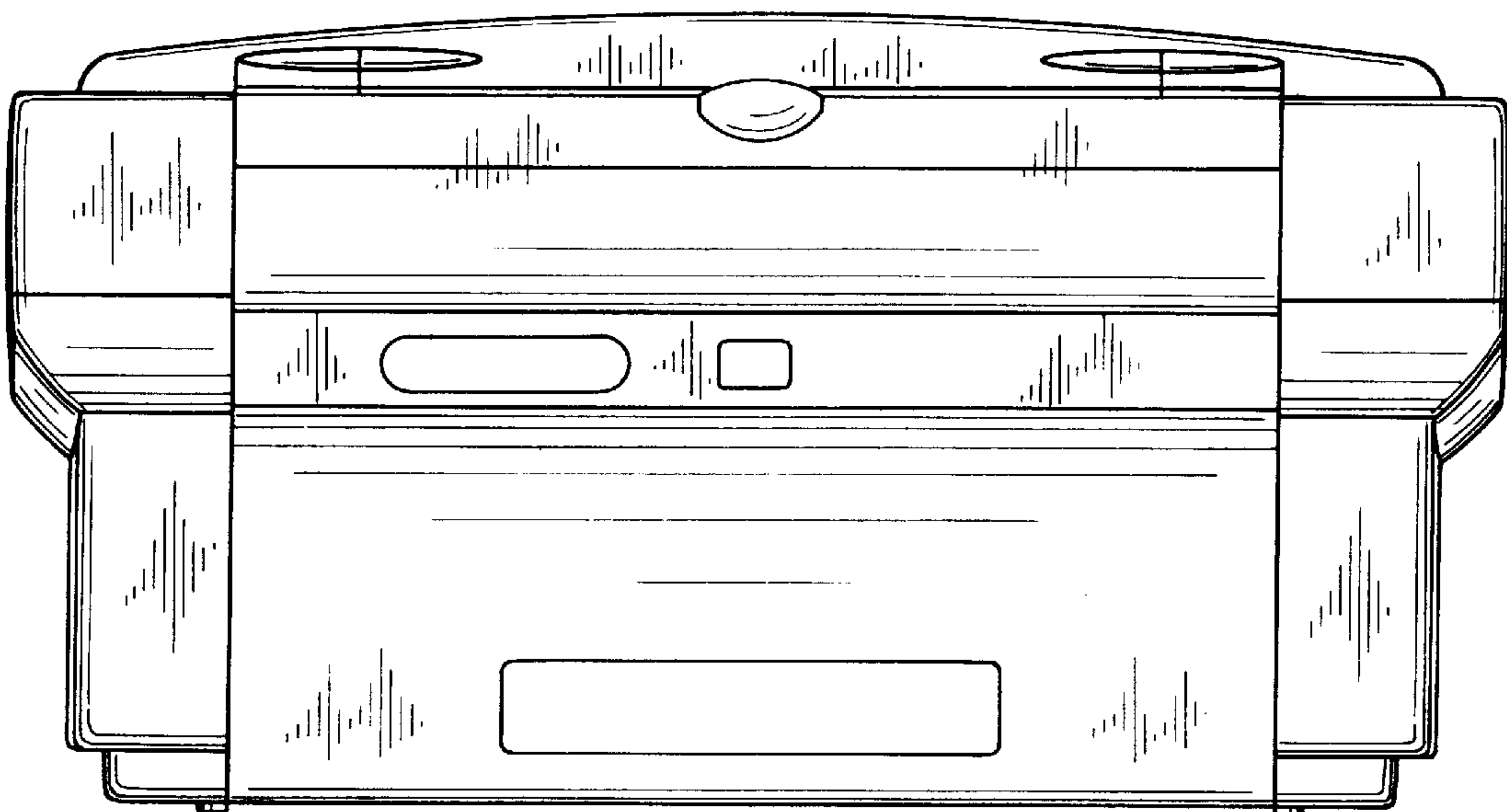
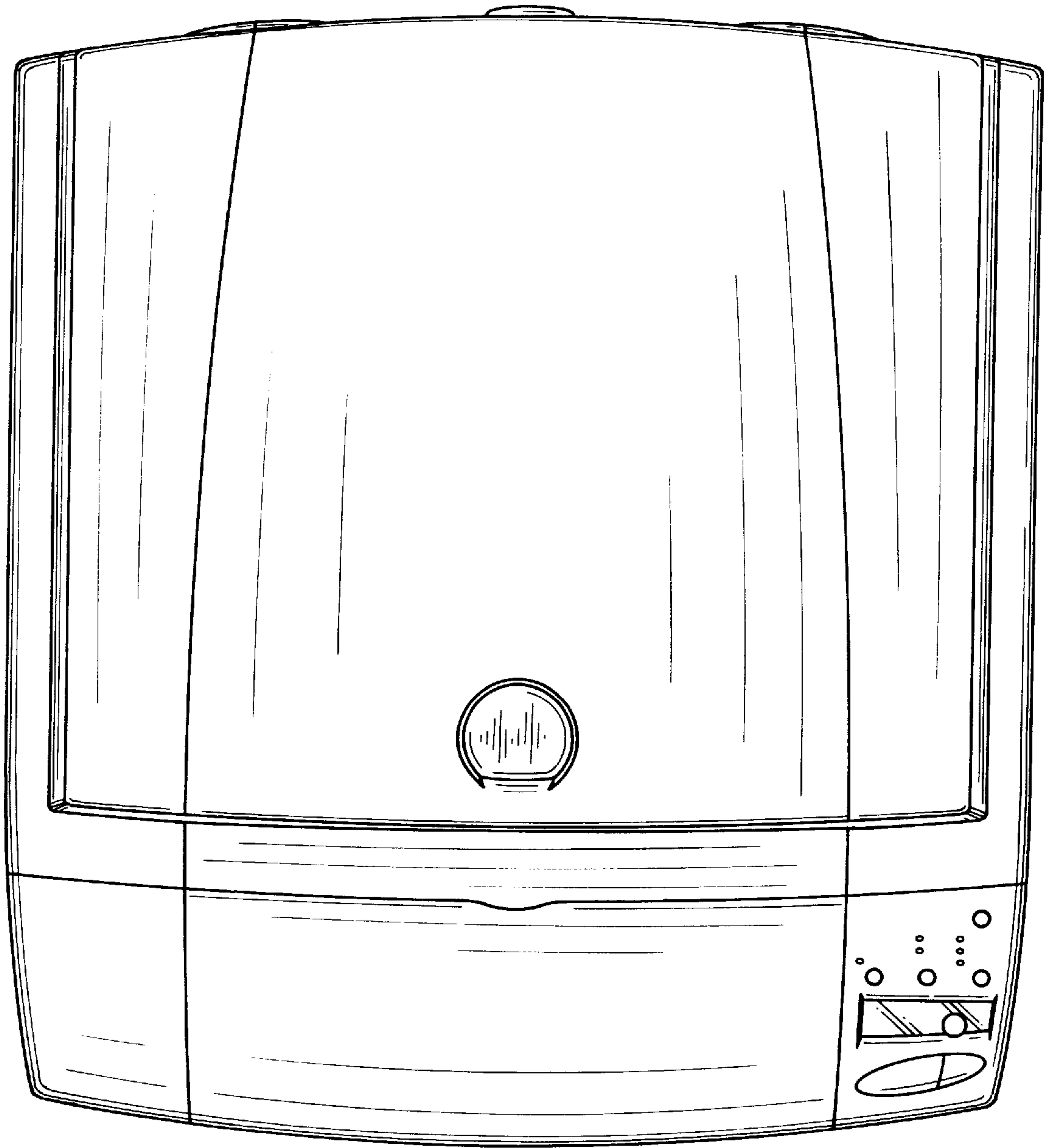
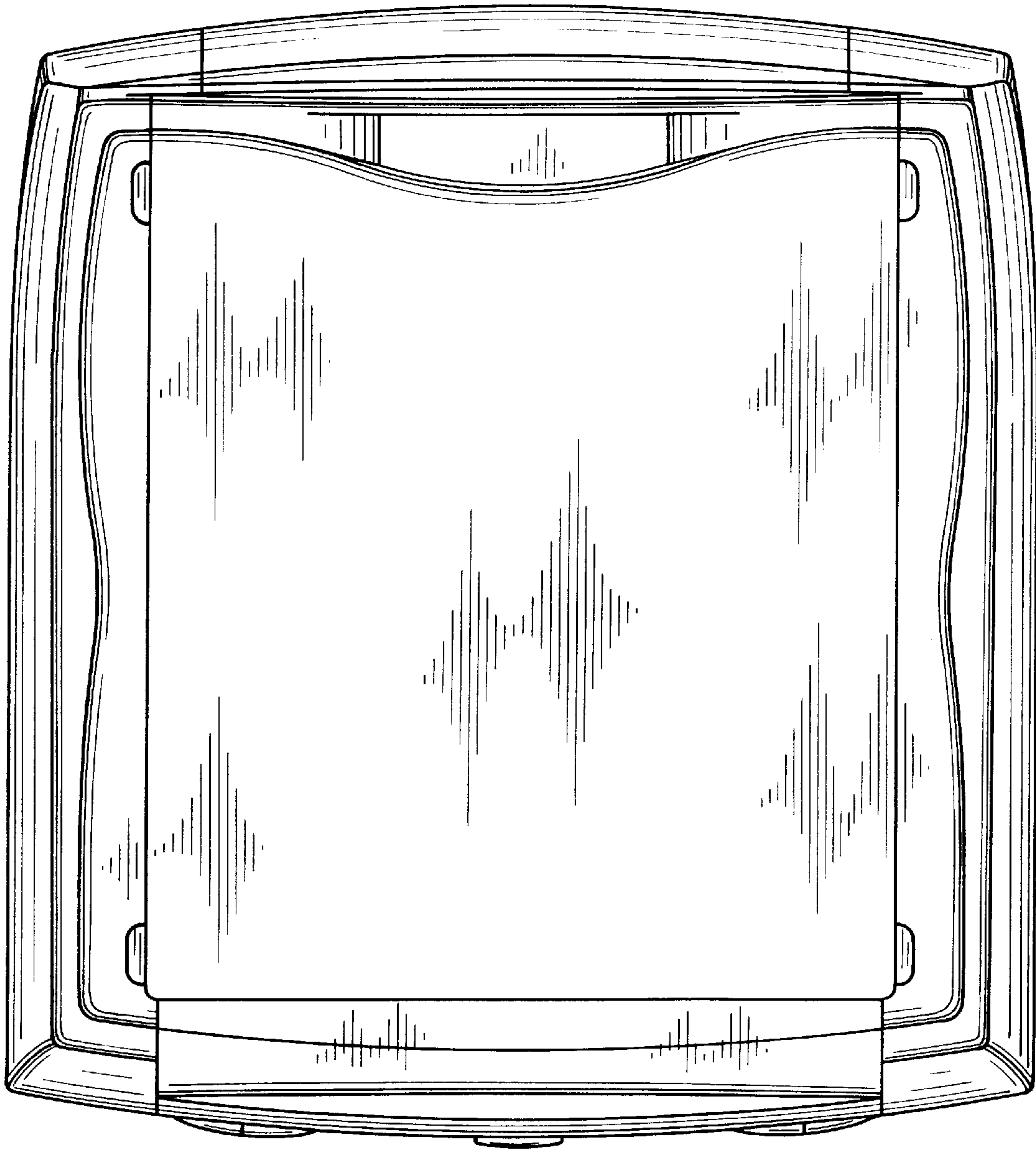

FIG. 3

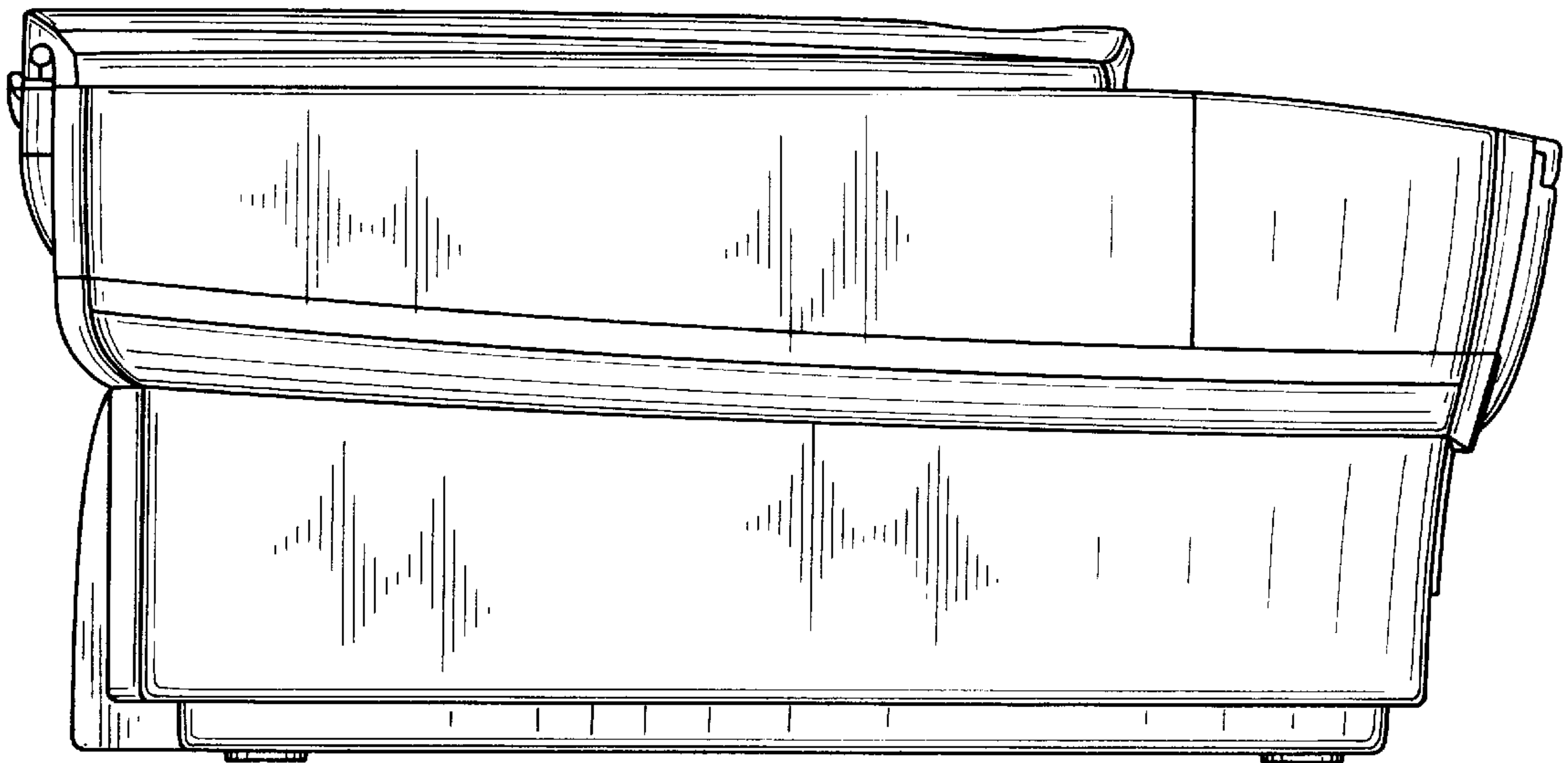

*FIG. 4*

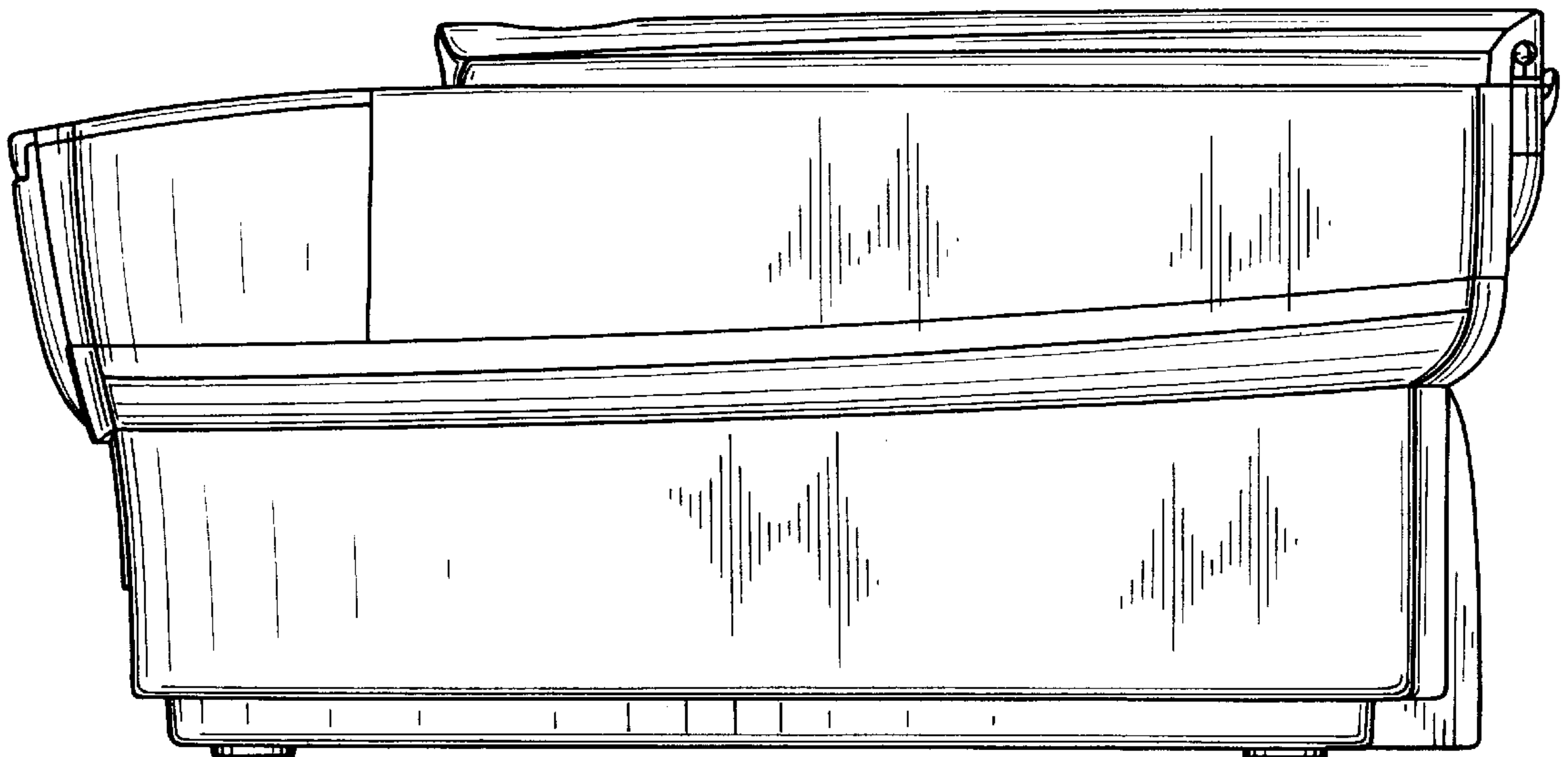



*FIG. 5*



*FIG. 6*



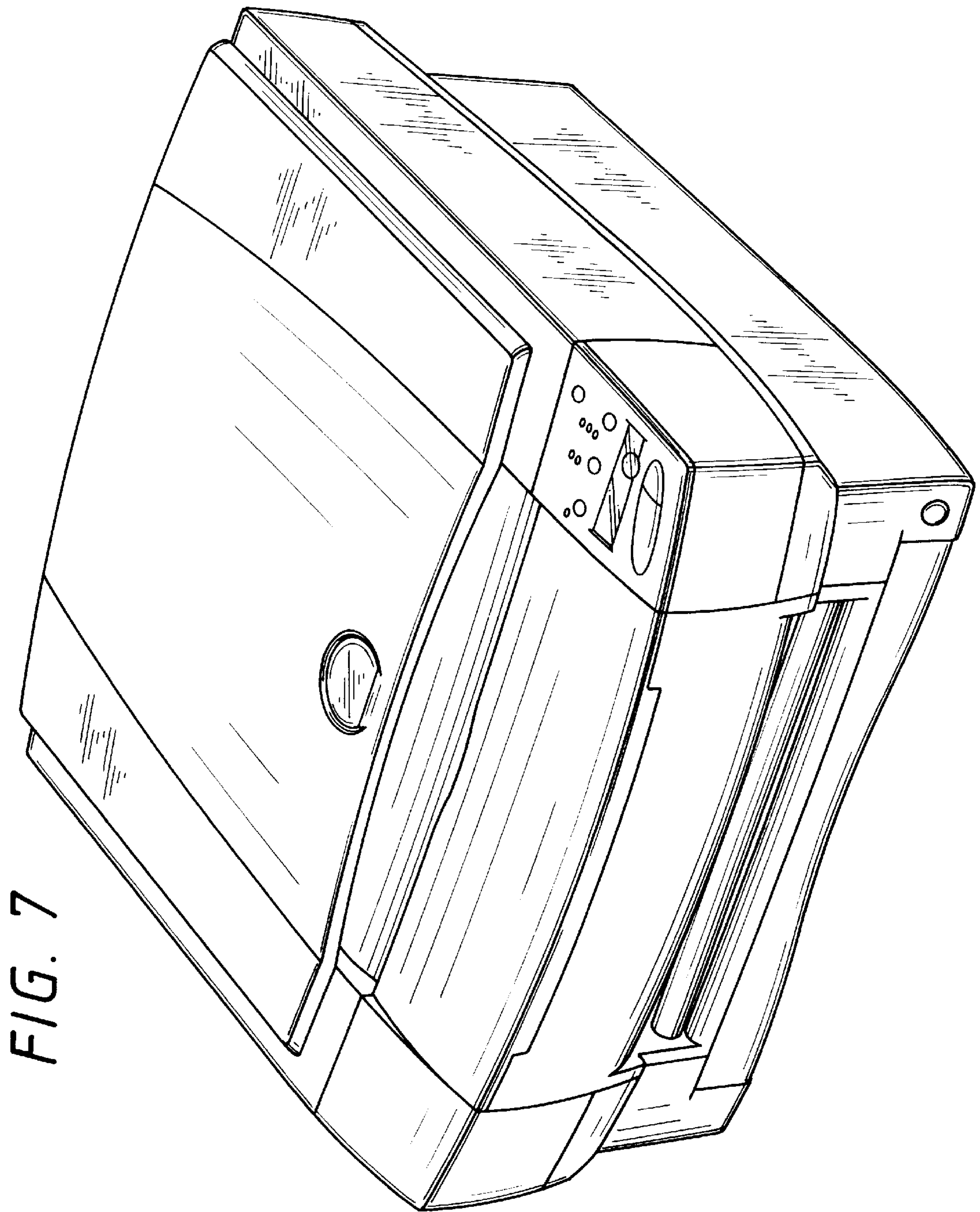

FIG. 7