



US00D430871S

United States Patent [19]

Chu et al.

[11] Patent Number: Des. 430,871

[45] Date of Patent: ** Sep. 12, 2000

[54] ELECTRONIC NOTEBOOK SUITABLE FOR TRAVELER

[76] Inventors: **William H. K. Chu**, 7F, No. 576, Chung-Hsiao E. Rd., Sec. 7; **Min-Hua Lin**, 4F, No. 14, Alley 70, Lane 180, Yeong-Jyi Rd., both of Taipei, Taiwan

[**] Term: 14 Years

[21] Appl. No.: 29/112,577

[22] Filed: Oct. 21, 1999

[51] LOC (7) Cl. 14-02

[52] U.S. Cl. D14/345

[58] Field of Search D14/341, 345, D14/346; D18/1, 2, 7; 235/145 A, 145 R; D19/26, 59, 60; 345/104, 156, 173, 168; 364/708.1; 349/12

[56] References Cited

U.S. PATENT DOCUMENTS

D. 310,543	9/1990	Brown	D14/345
D. 311,908	11/1990	Molyneaux	D14/345
D. 333,298	2/1993	Raslowsky et al.	D14/345
D. 357,230	4/1995	Wahl	D14/345

Primary Examiner—Freda Nunn
Attorney, Agent, or Firm—Dougherty & Troxell

[57] CLAIM

The ornamental design for the electronic notebook suitable for traveler, as shown and described.

DESCRIPTION

FIG. 1 is a perspective view of the electronic notebook suitable for traveler in open state, showing the new design; FIG. 2 is a front view of the electronic notebook suitable for traveler in open state; FIG. 3 is a rear view of the electronic notebook suitable for traveler in open state; FIG. 4 is a left side view of the electronic notebook suitable for traveler in open state; FIG. 5 is a right side view of the electronic notebook suitable for traveler in open state; FIG. 6 is a top view of the electronic notebook suitable for traveler in open state; FIG. 7 is a bottom view of the electronic notebook suitable for traveler in open state; FIG. 8 is a perspective view of the electronic notebook suitable for traveler in close state; FIG. 9 is a front view of the electronic notebook suitable for traveler in close state; FIG. 10 is a rear view of the electronic notebook suitable for traveler in close state; FIG. 11 is a left side view of the electronic notebook suitable for traveler in close state; FIG. 12 is a right side view of the electronic notebook suitable for traveler in close state; FIG. 13 is a top view of the electronic notebook suitable for traveler in close state; and, FIG. 14 is a bottom of the electronic notebook suitable for traveler in close state.

1 Claim, 8 Drawing Sheets

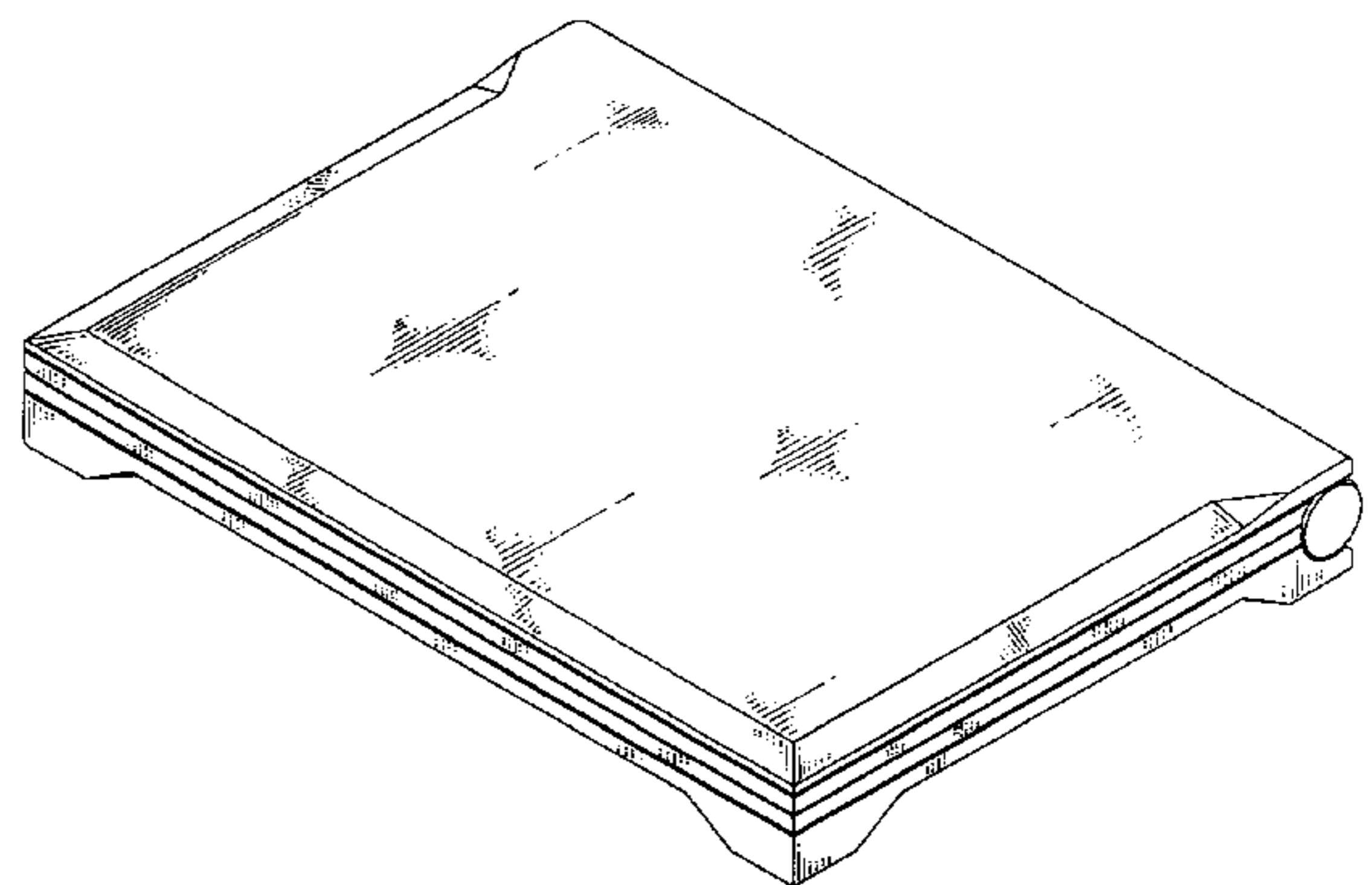
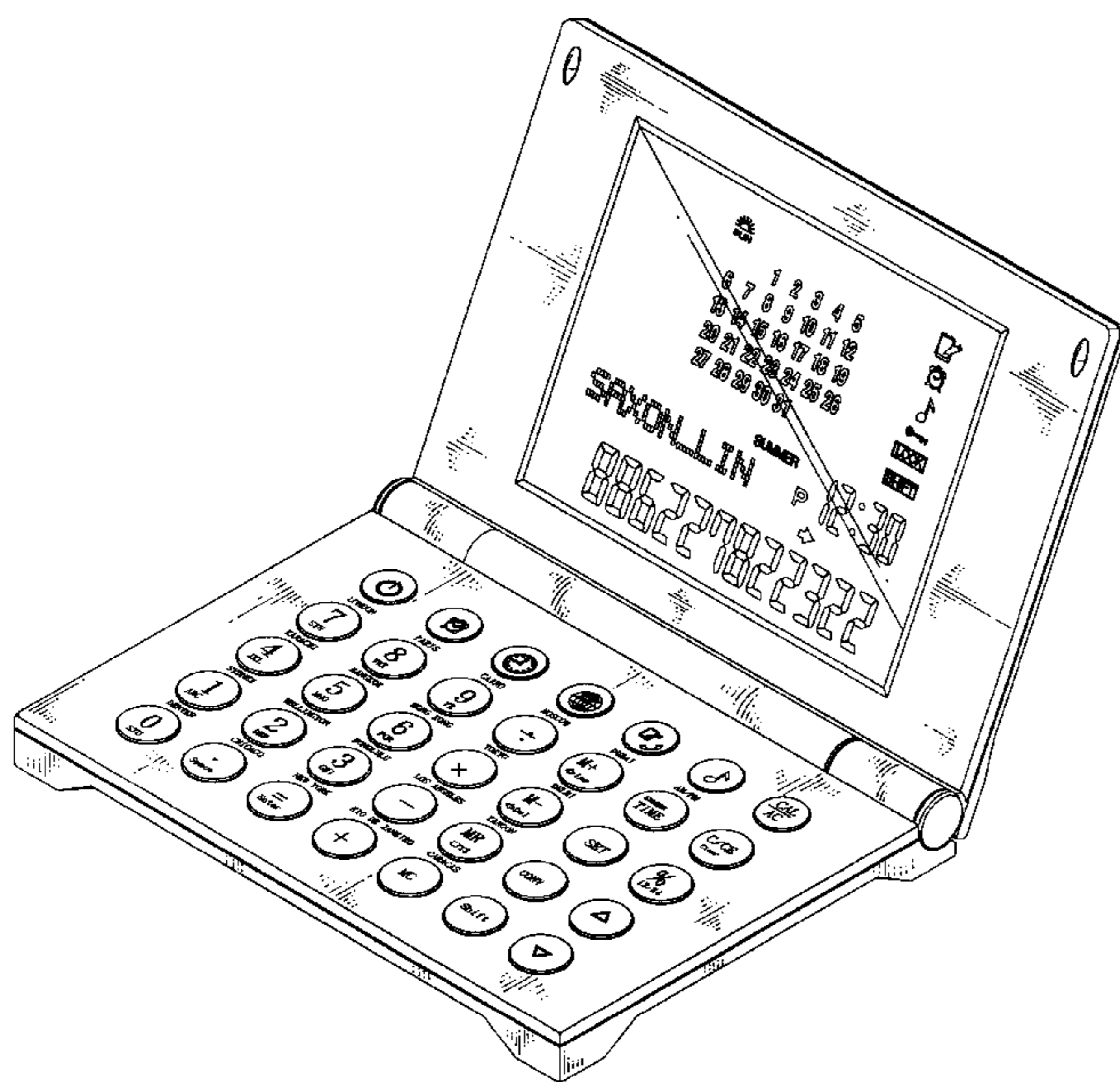

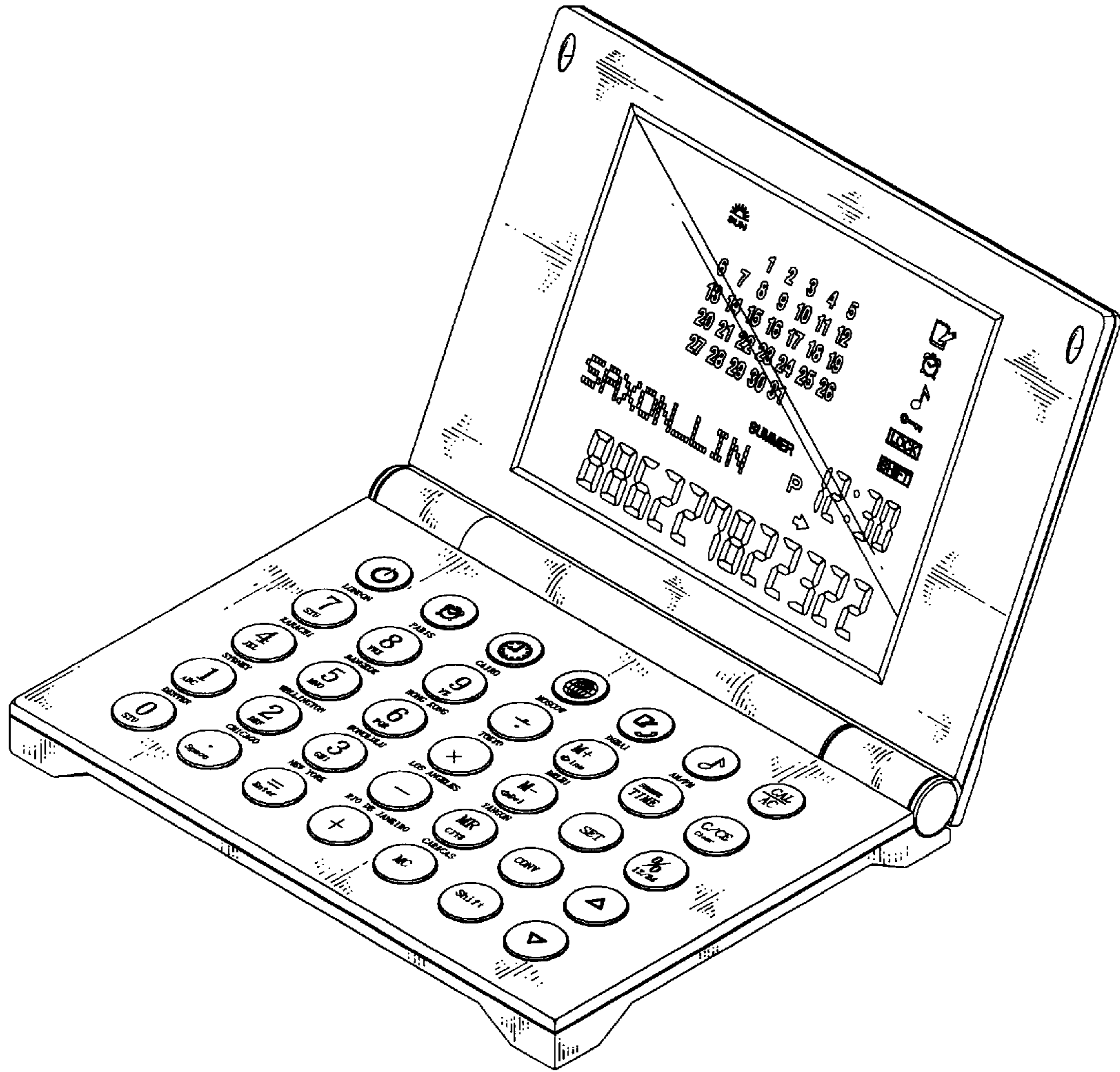

Fig. 1

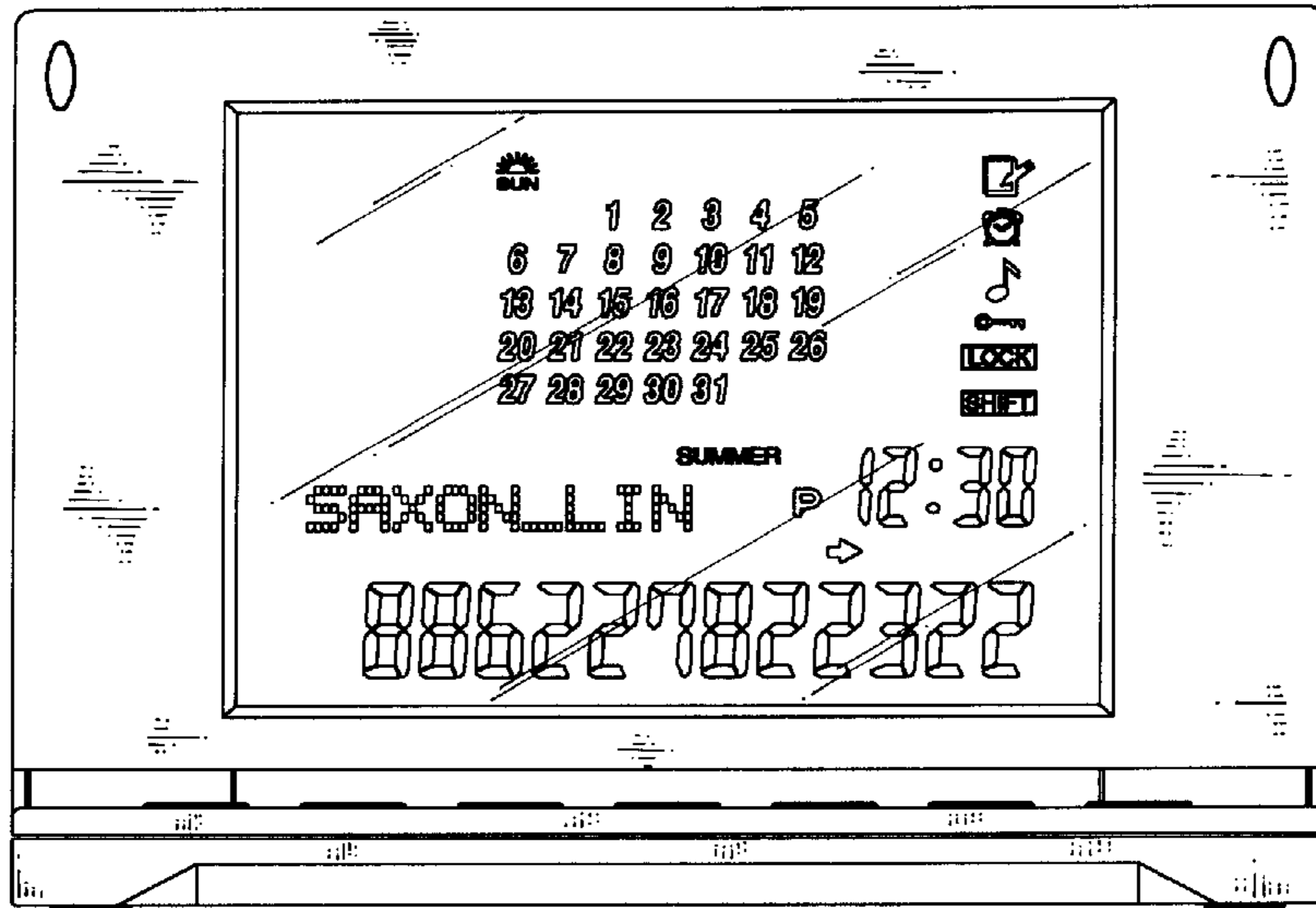

Fig. 2

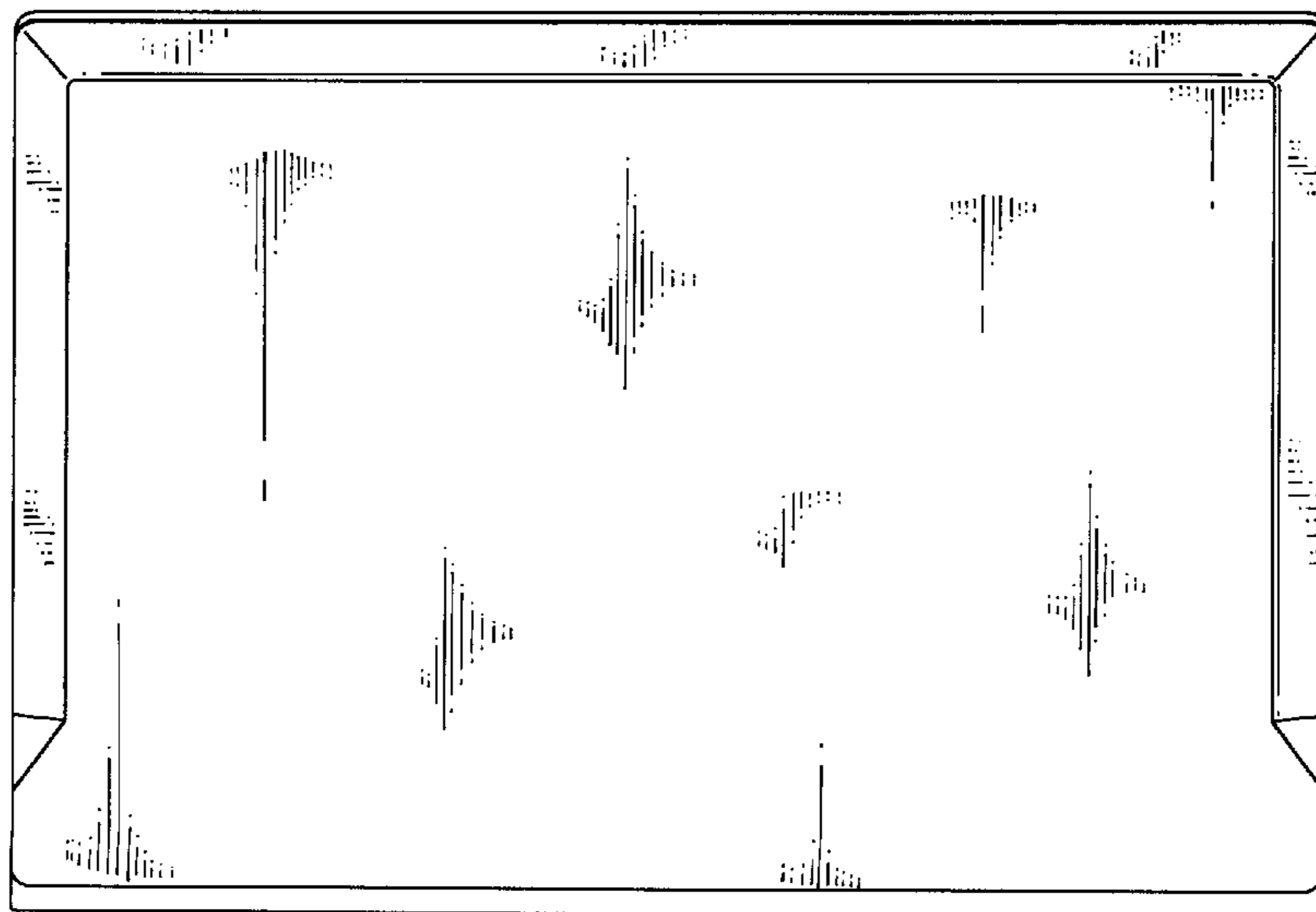

Fig. 3

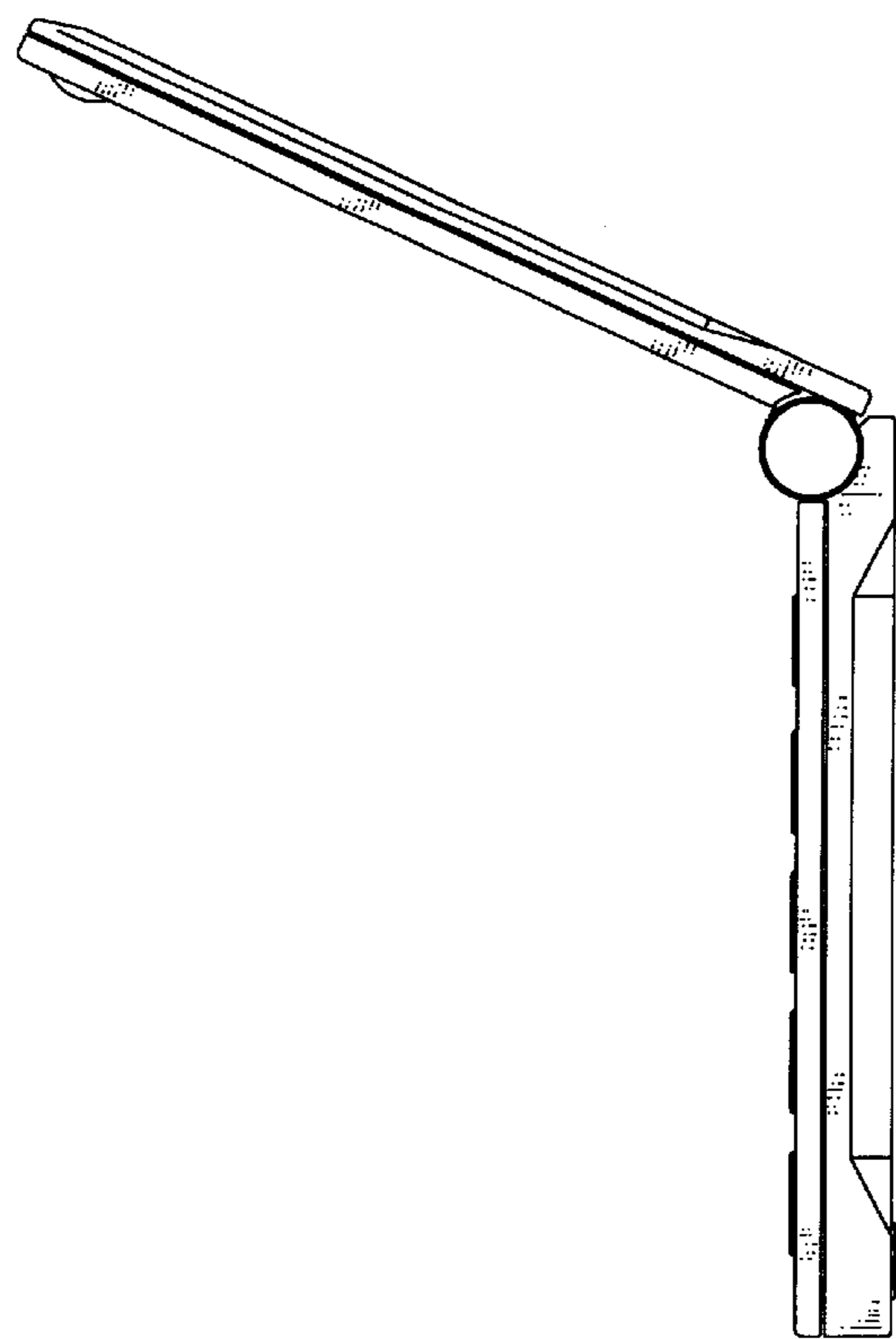

Fig. 5

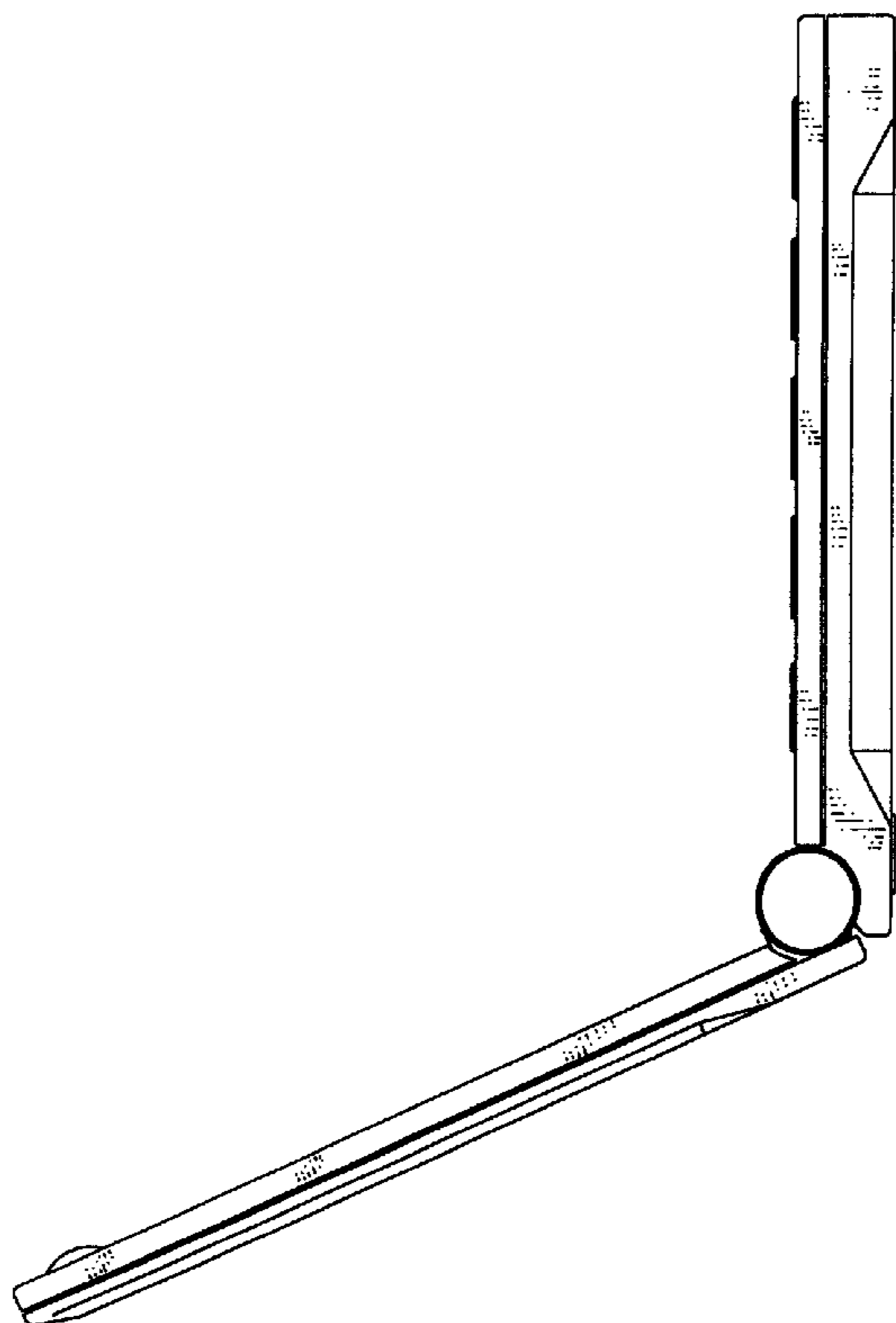

Fig. 4

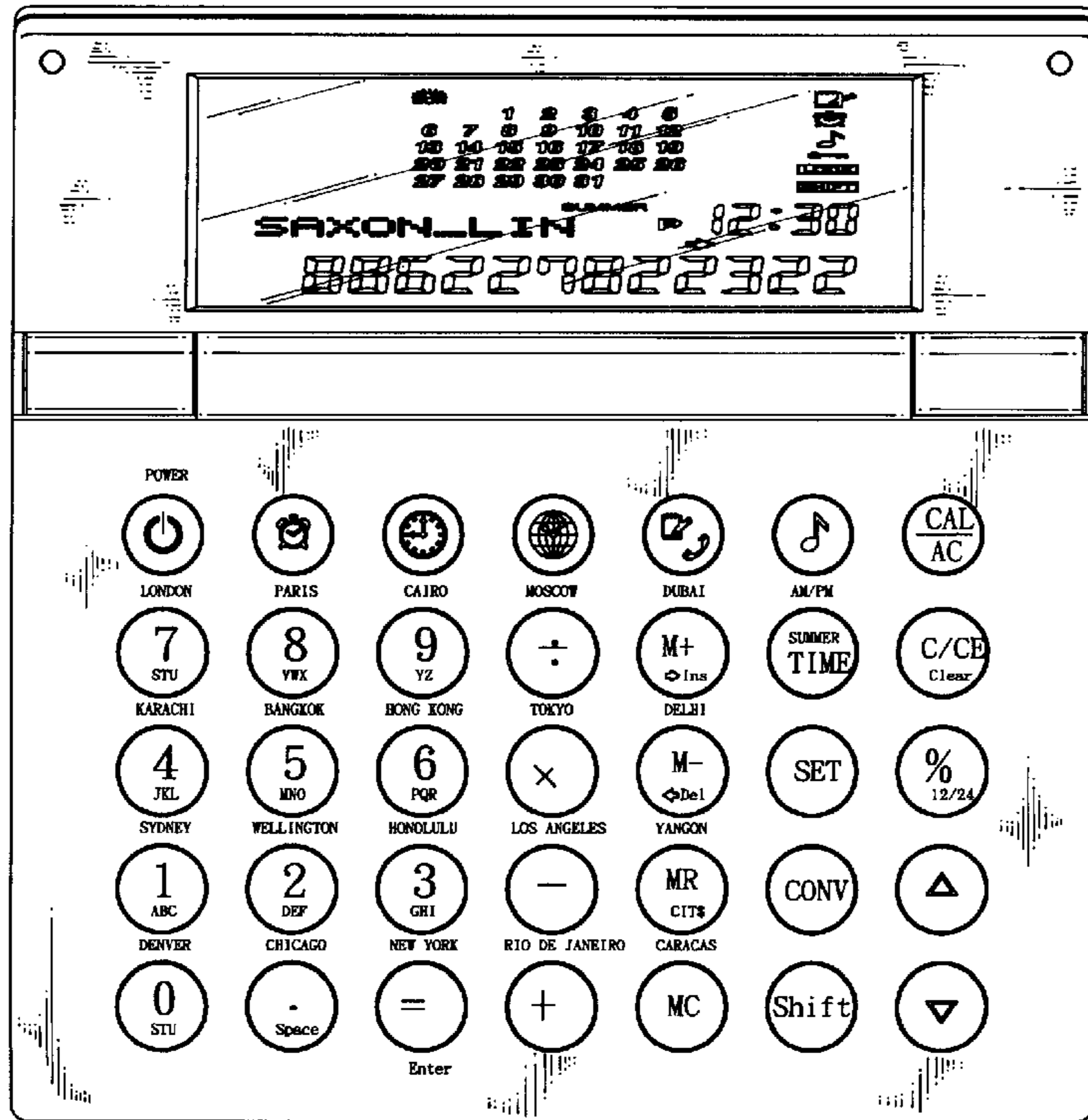

Fig. 6

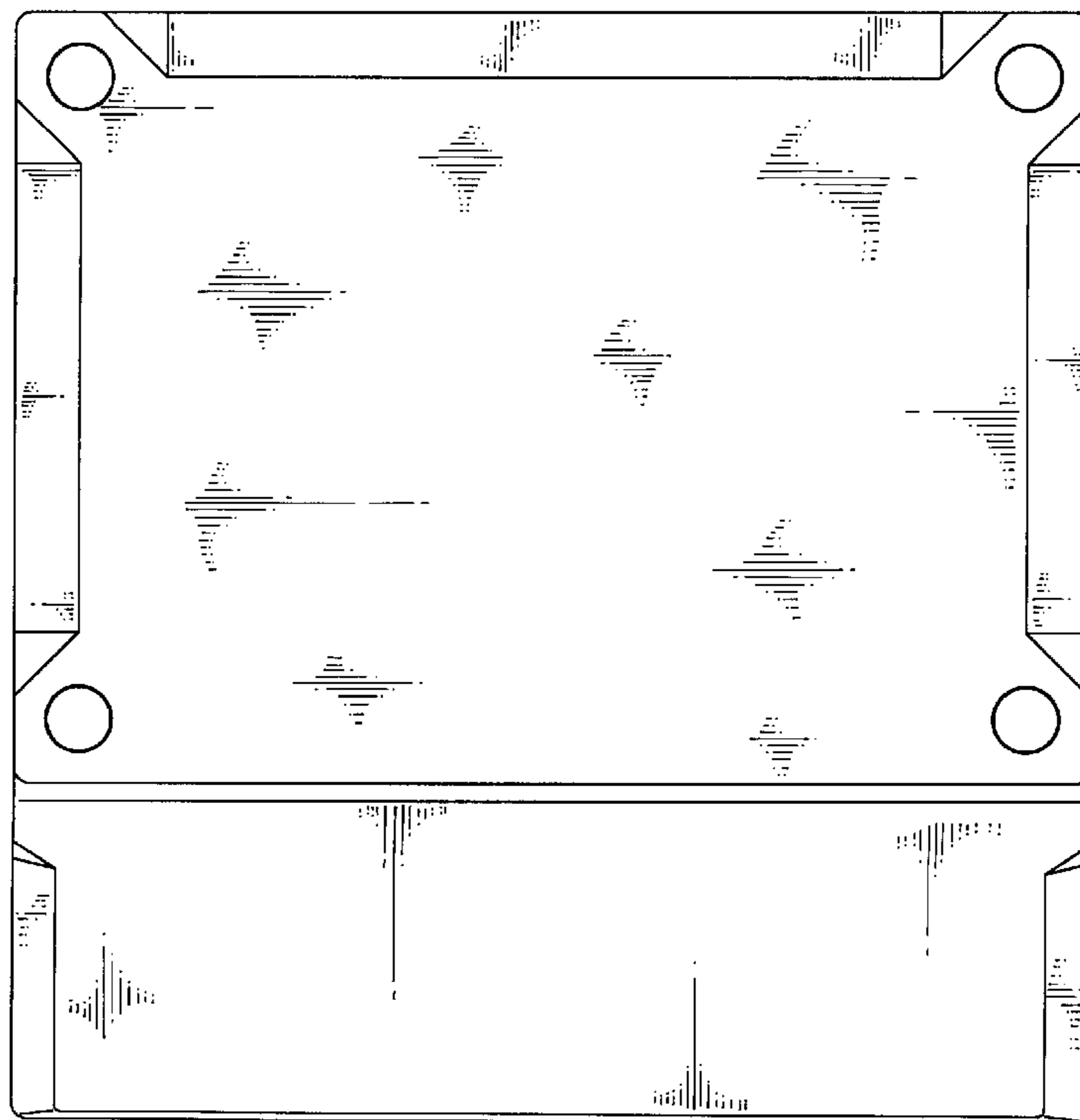

Fig. 7

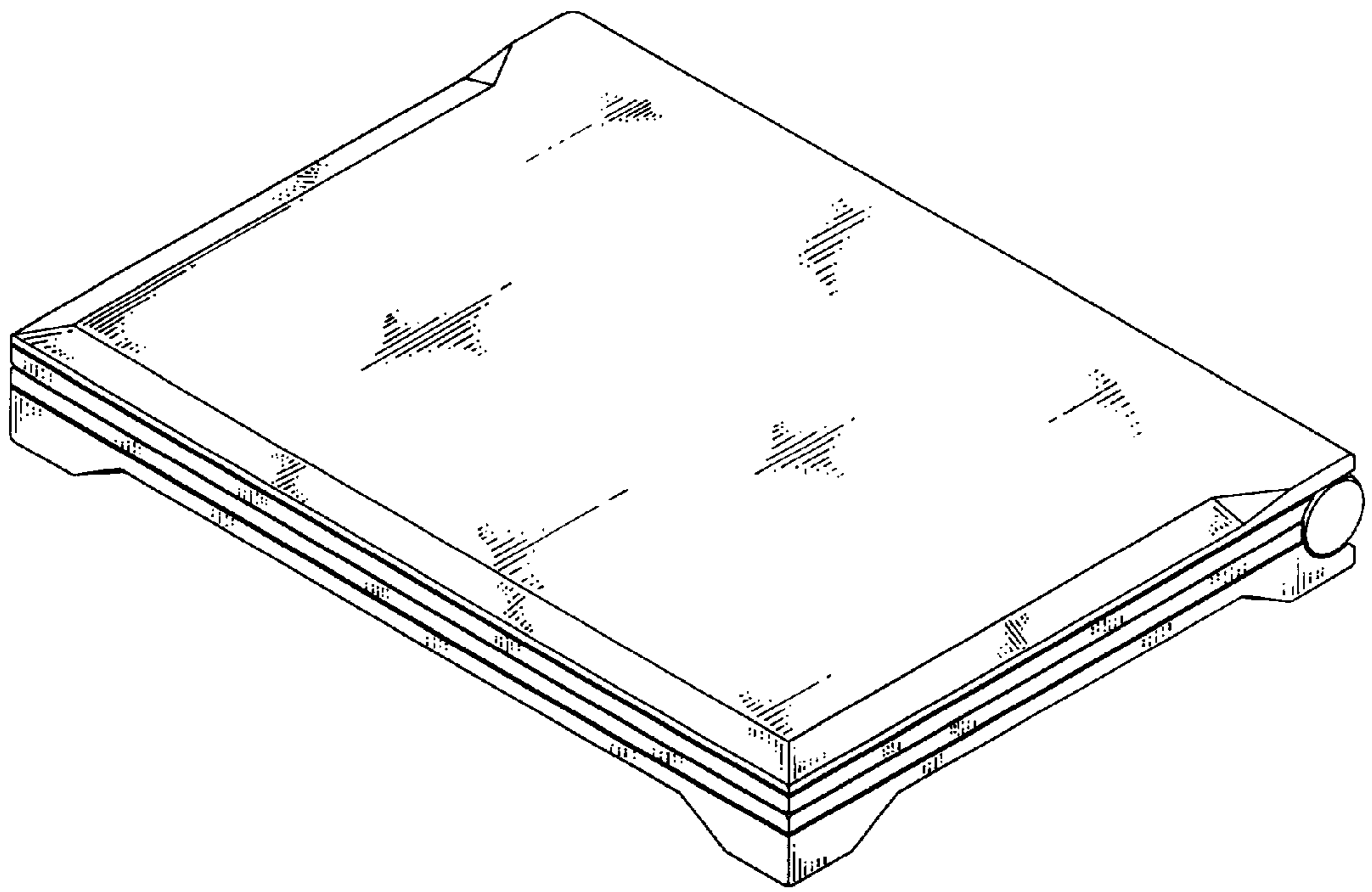

Fig. 8

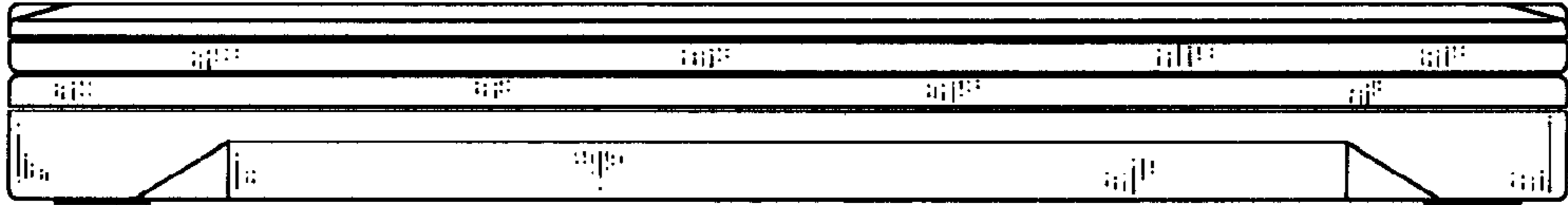

Fig. 9

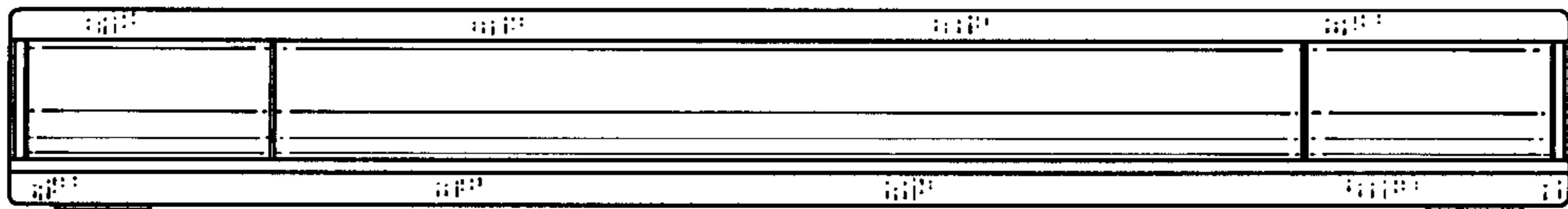

Fig. 10

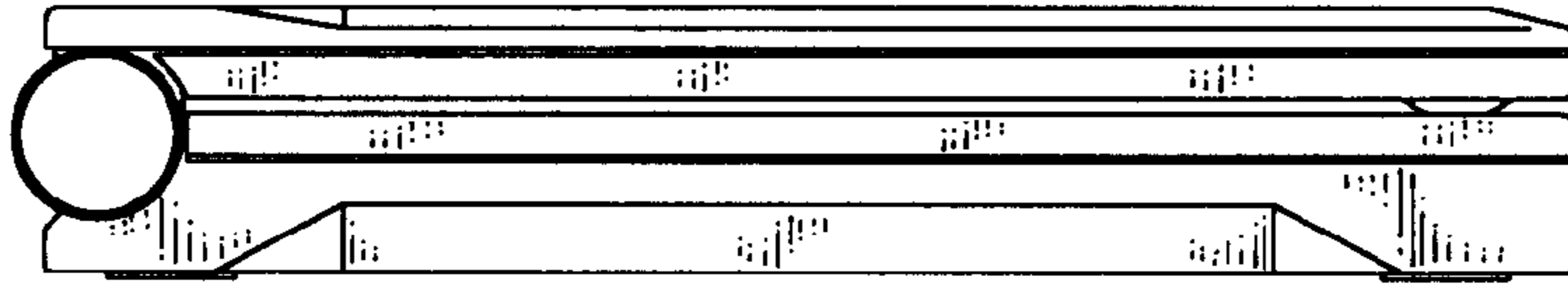

Fig. 11

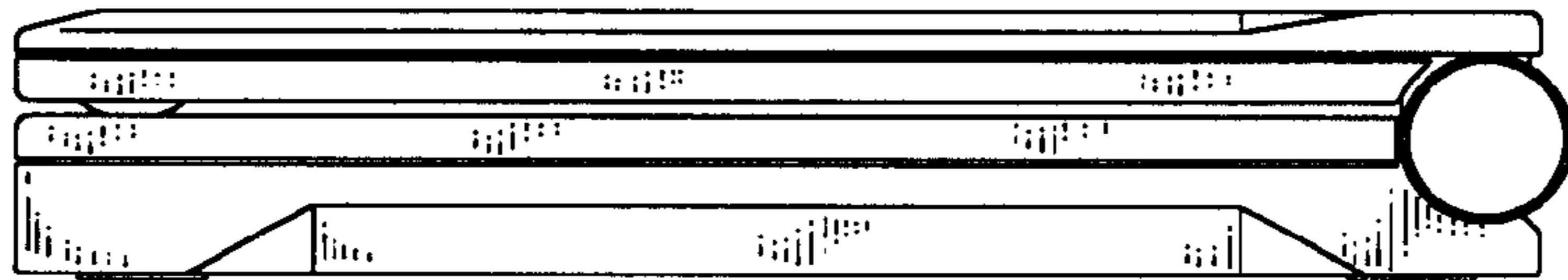

Fig. 12

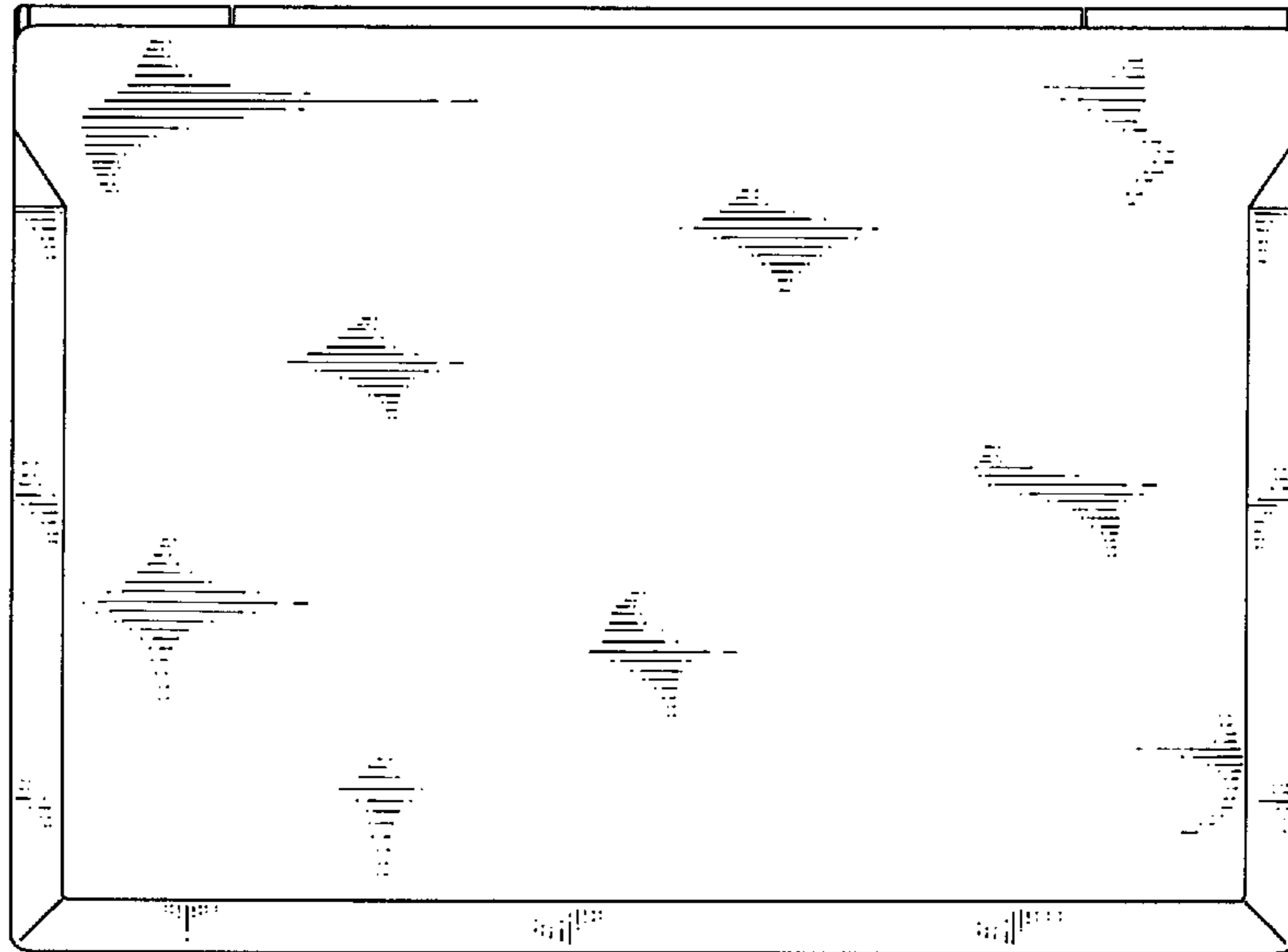

Fig. 13

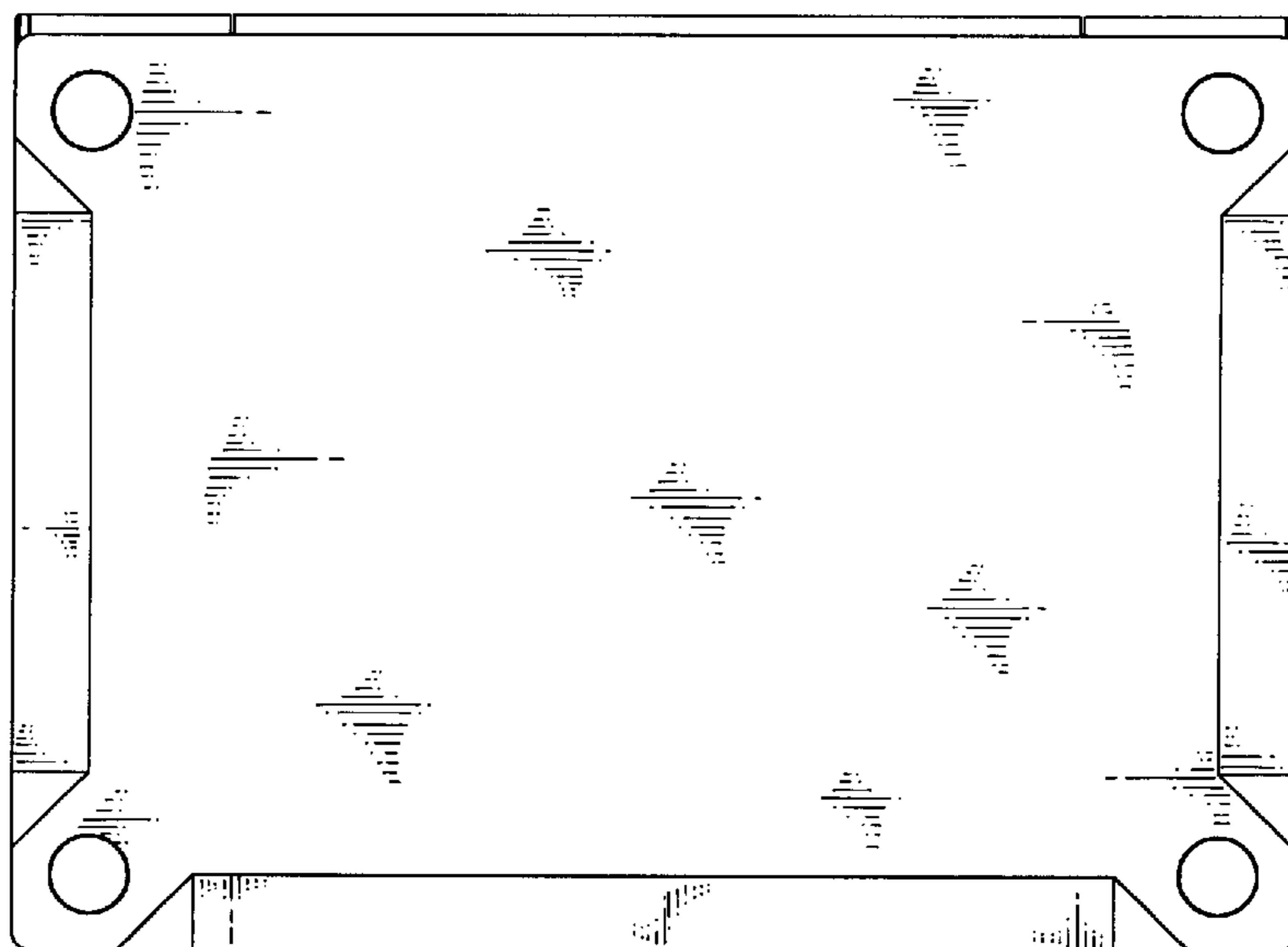

Fig. 14