



US00D430812S

United States Patent [19]

[11] **Patent Number: Des. 430,812**

Levin et al.

[45] **Date of Patent: ** Sep. 12, 2000**

[54] **PULSE OXIMETER WITH THERMOMETER**

Primary Examiner—Antoine Duval Davis
Attorney, Agent, or Firm—Bruce H. Johnsonbaugh

[75] Inventors: **Paul D. Levin**, Santa Cruz; **Ben Clawson**, Soquel; **Vincent J. Suro**, Monterey; **Shaun Fogarty**; **Jeff Sanders**, both of Santa Cruz; **Edward A Oliver**, Los Gatos, all of Calif.

[57] **CLAIM**

The ornamental design for a pulse oximeter with thermometer, as shown and described.

[73] Assignee: **Palco Labs, Inc.**, Santa Cruz, Calif.

DESCRIPTION

[**] Term: **14 Years**

FIG. 1 is a front view of a pulse oximeter with thermometer showing our new design;
FIG. 2 is a rear view;
FIG. 3 is a front right perspective view;
FIG. 4 is a front right perspective view showing the probe cover container open;
FIG. 5 is a front left perspective view;
FIG. 6 is a right side view;
FIG. 7 is a left side view;
FIG. 8 is a top view; and,
FIG. 9 is a bottom view.

[21] Appl. No.: **29/114,071**

[22] Filed: **Nov. 17, 1999**

[51] **LOC (7) Cl.** **10-04**

[52] **U.S. Cl.** **D10/81; D10/78**

[58] **Field of Search** **D10/78, 81, 57; 600/323, 310, 316, 322, 340, 344; 128/633**

[56] **References Cited**

U.S. PATENT DOCUMENTS

6,006,120 12/1999 Levin 600/323

1 Claim, 9 Drawing Sheets

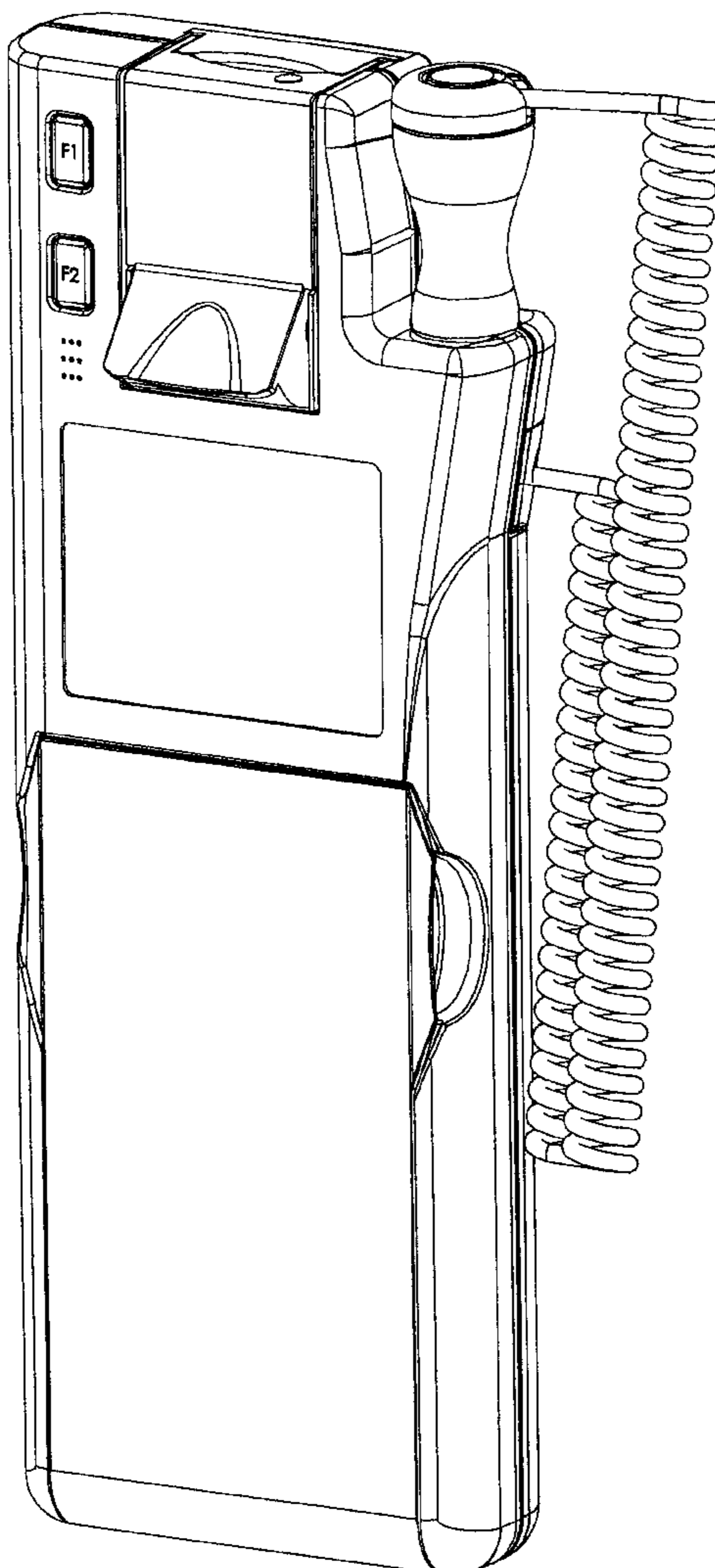

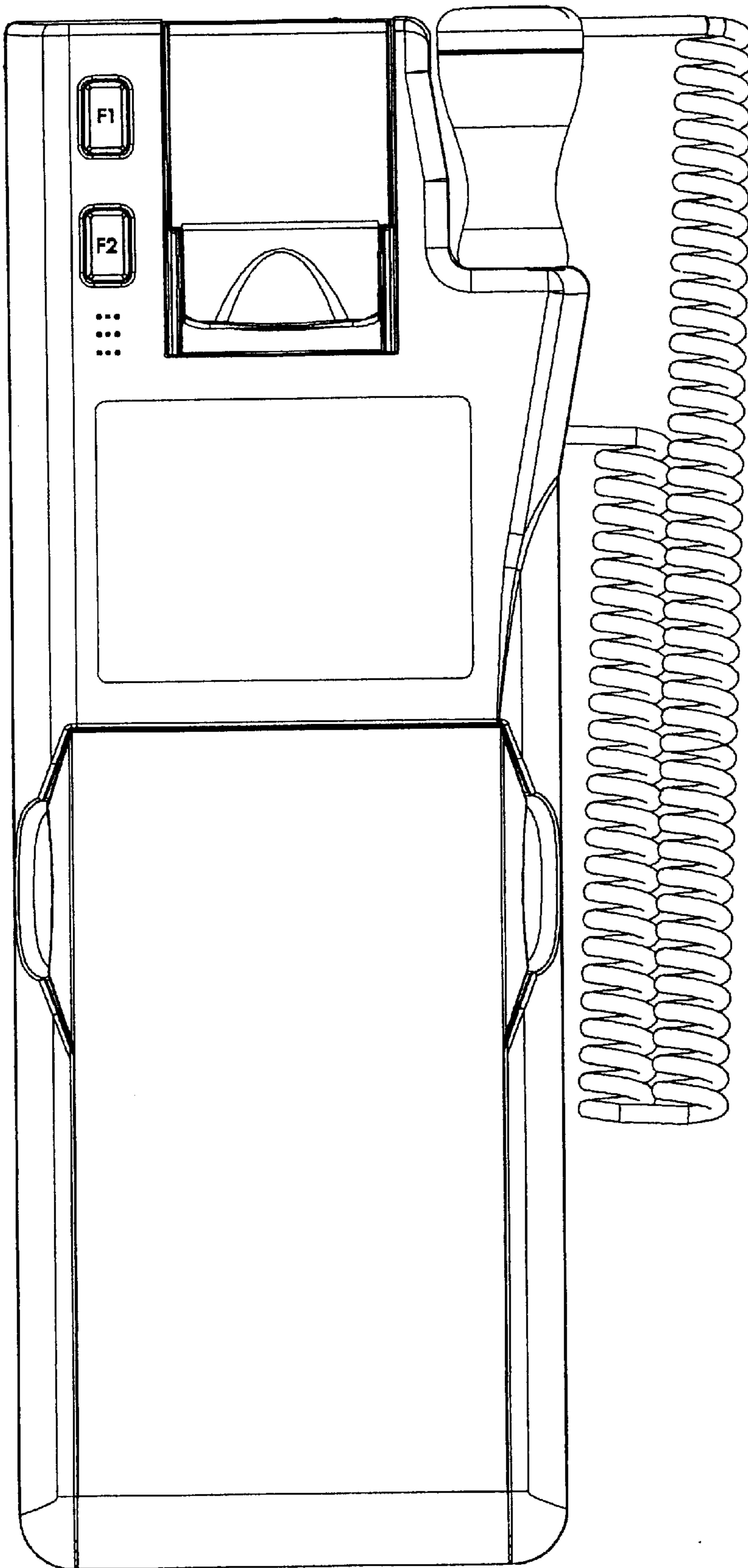

FIG. 1

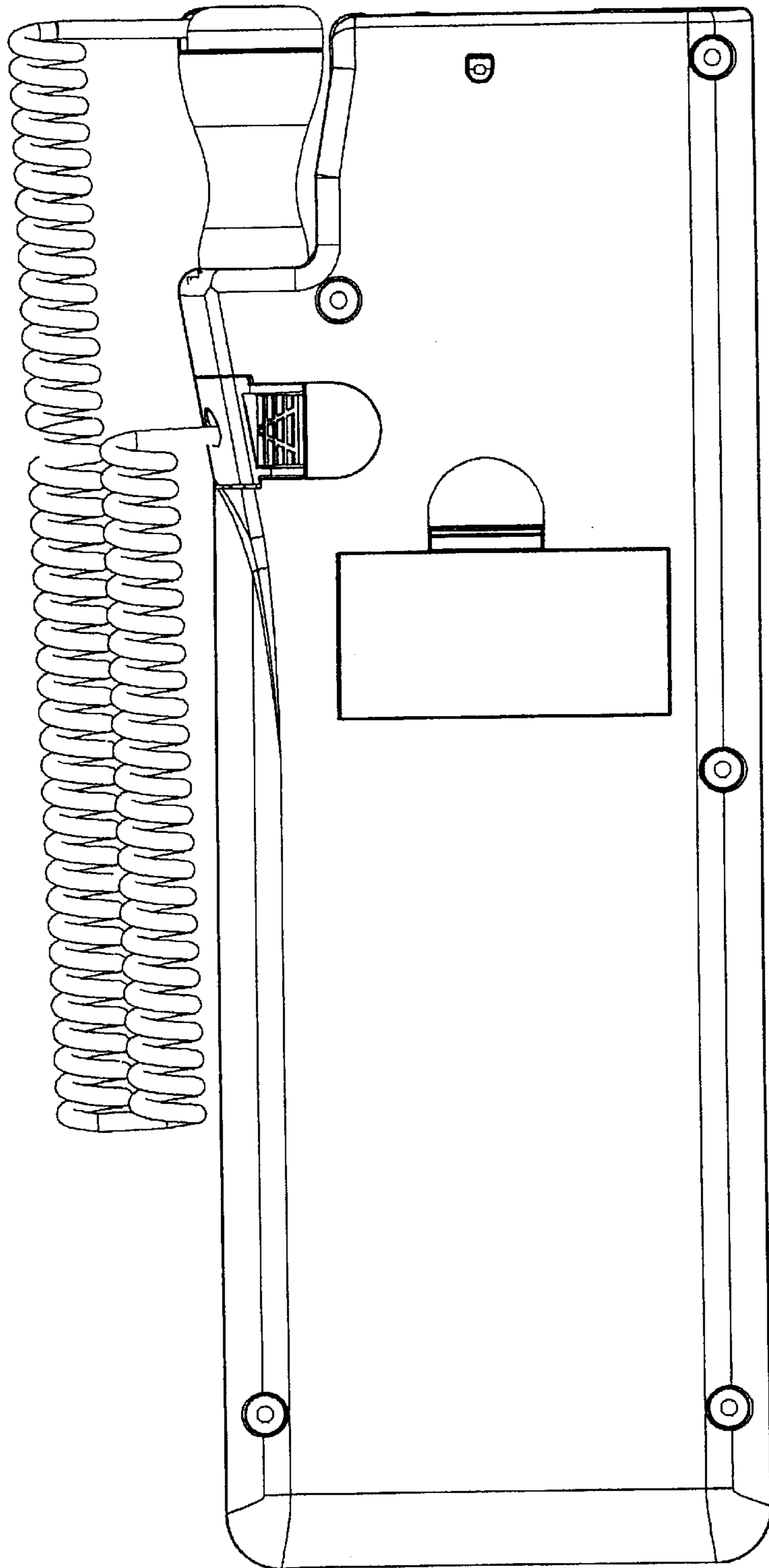

fig 2

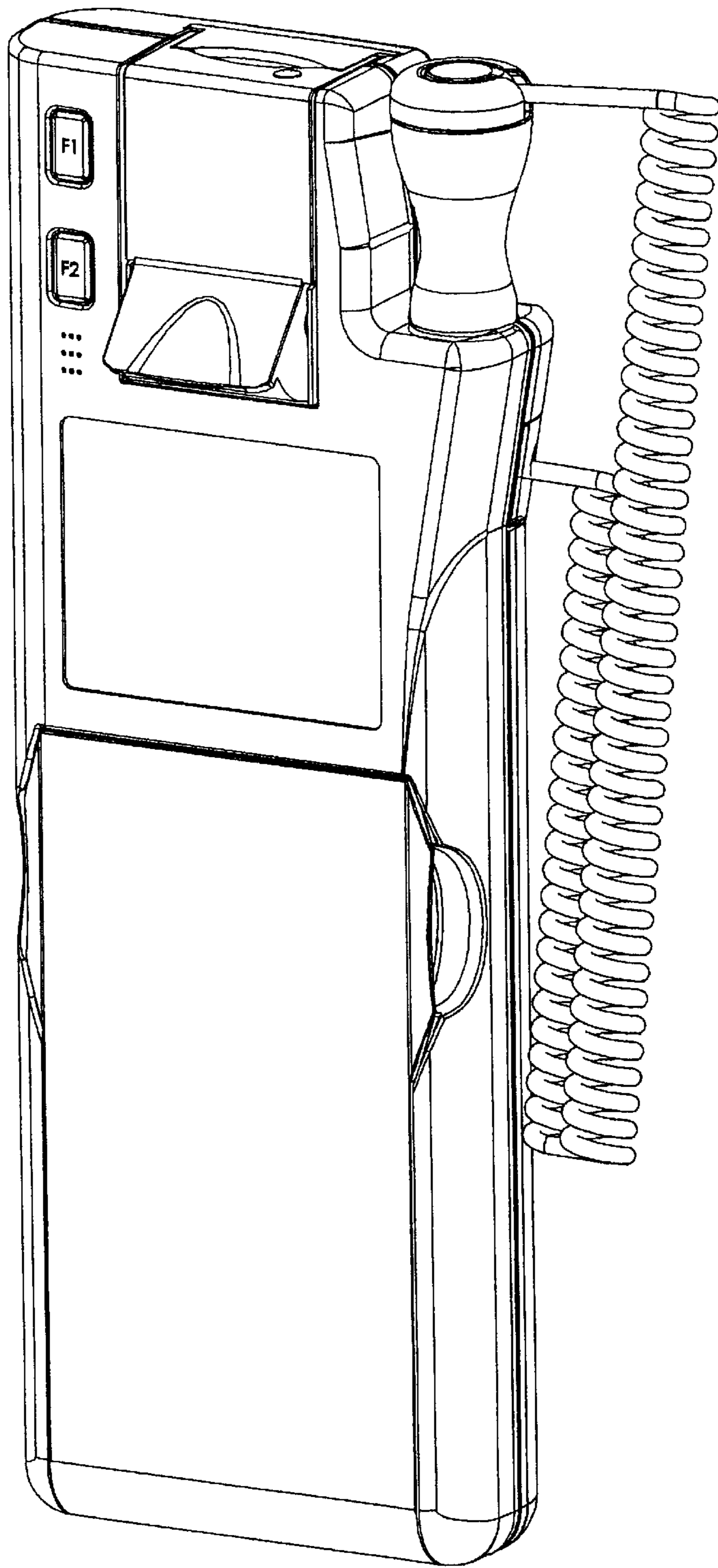

Fig 3

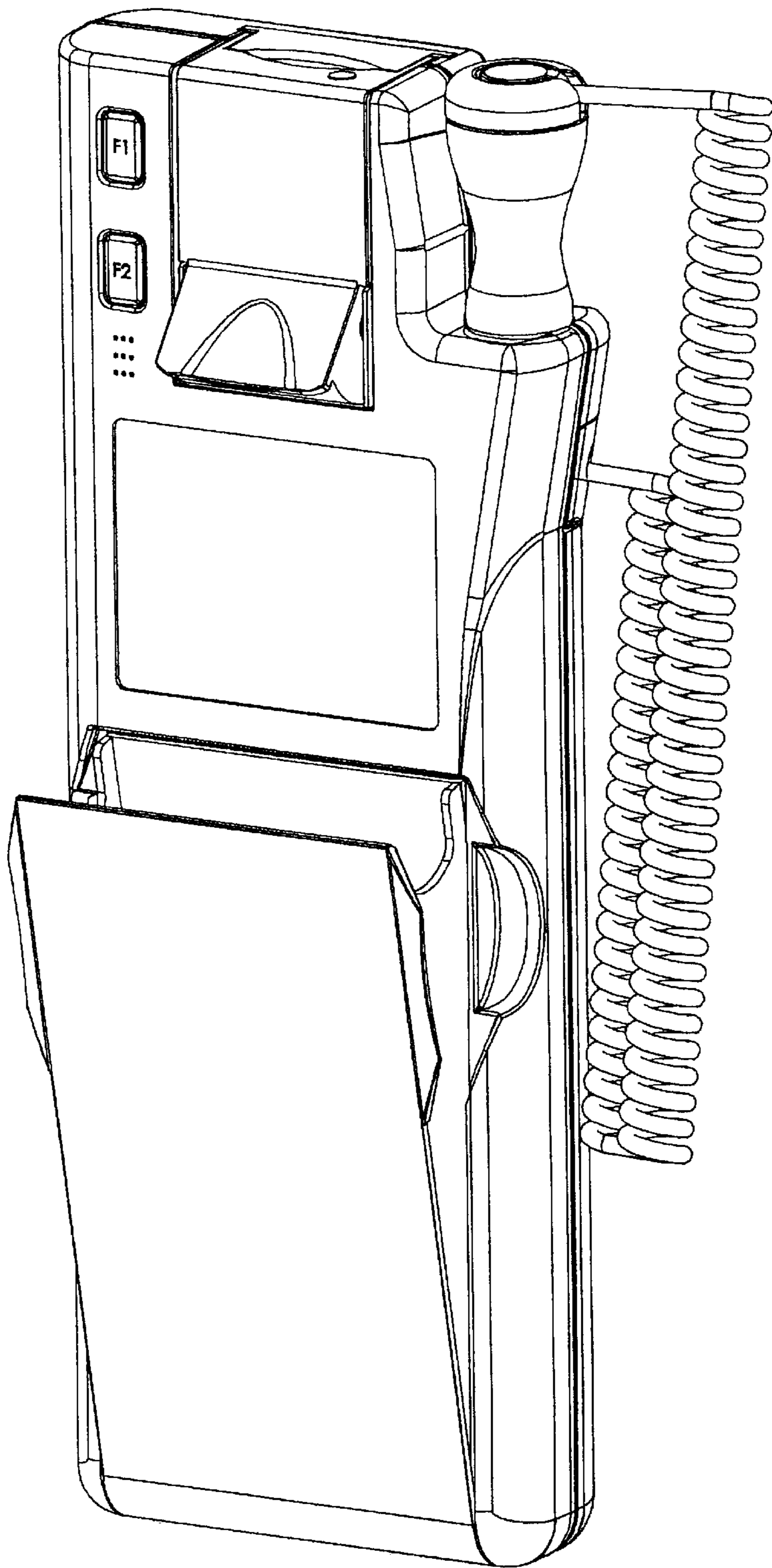

Fig 4

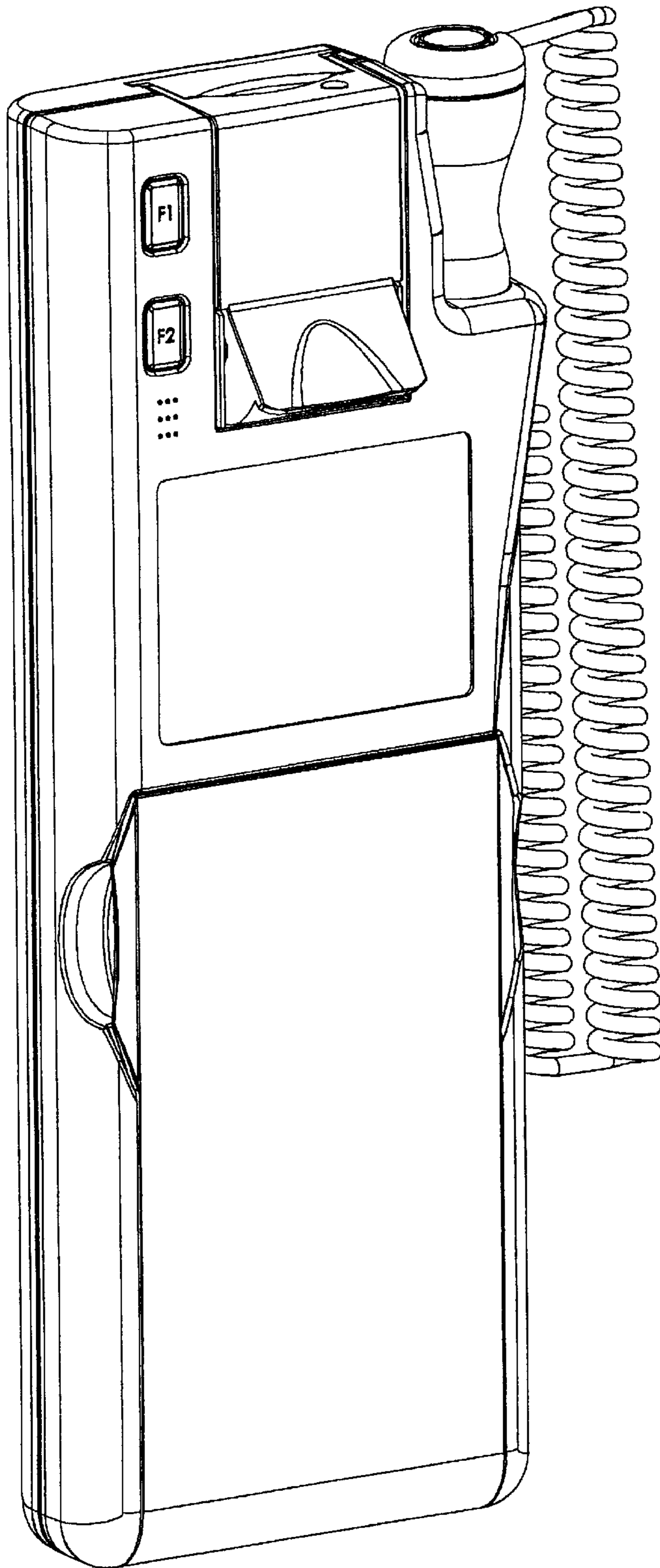

Fig 5

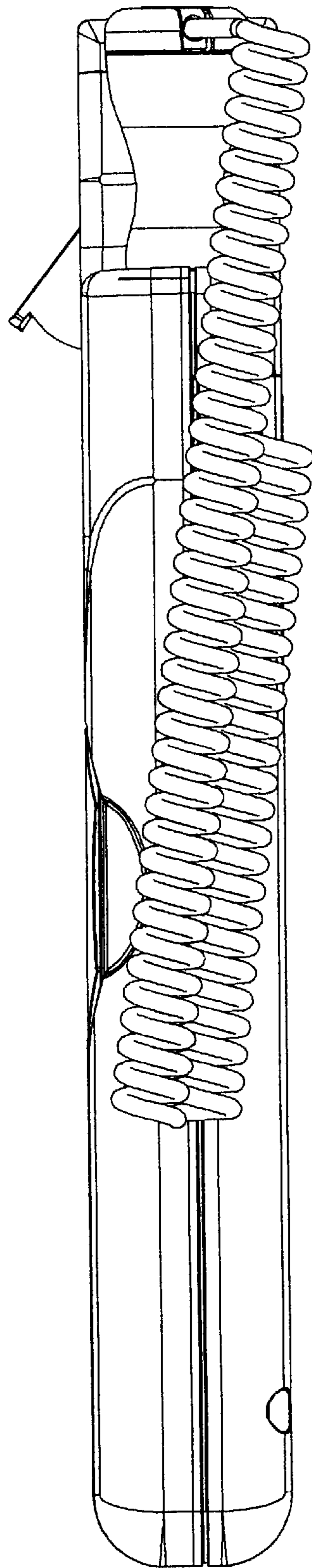

Fig 6

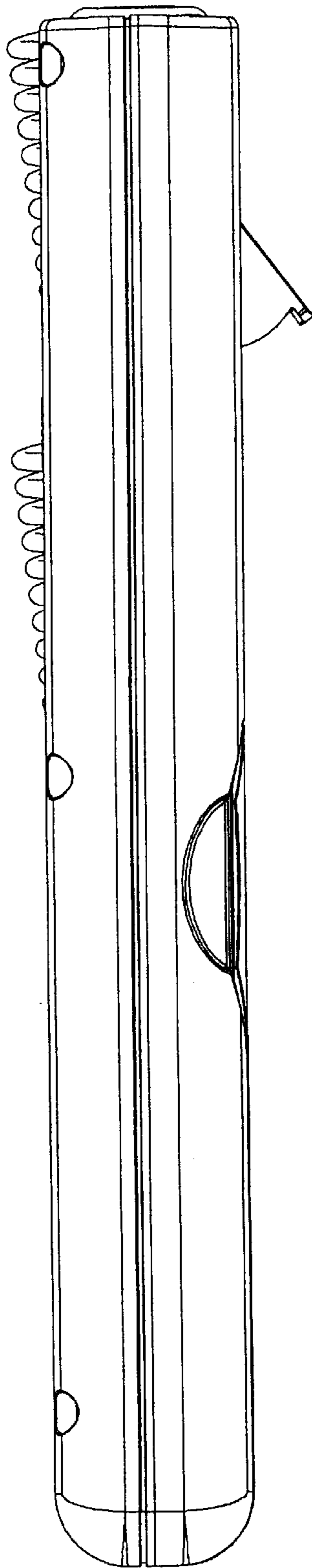

Fig 7

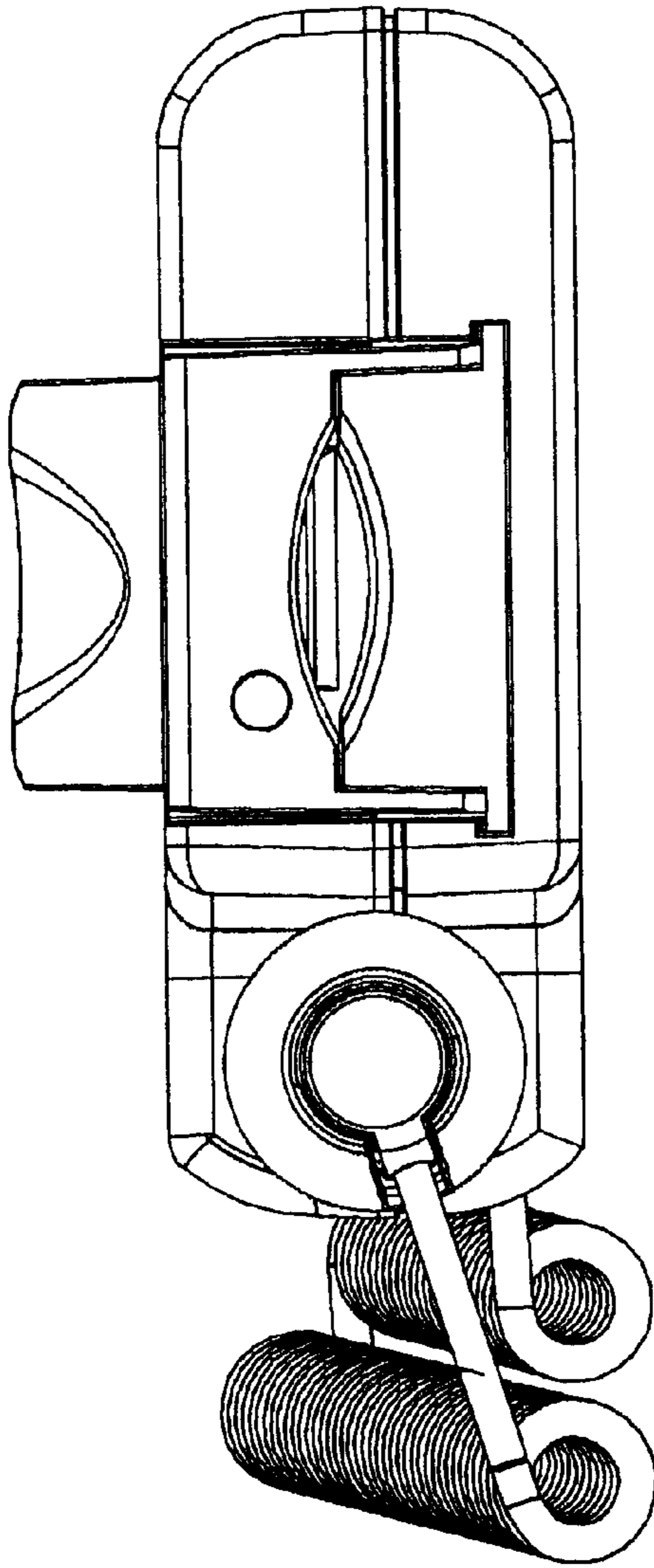

Fig 2

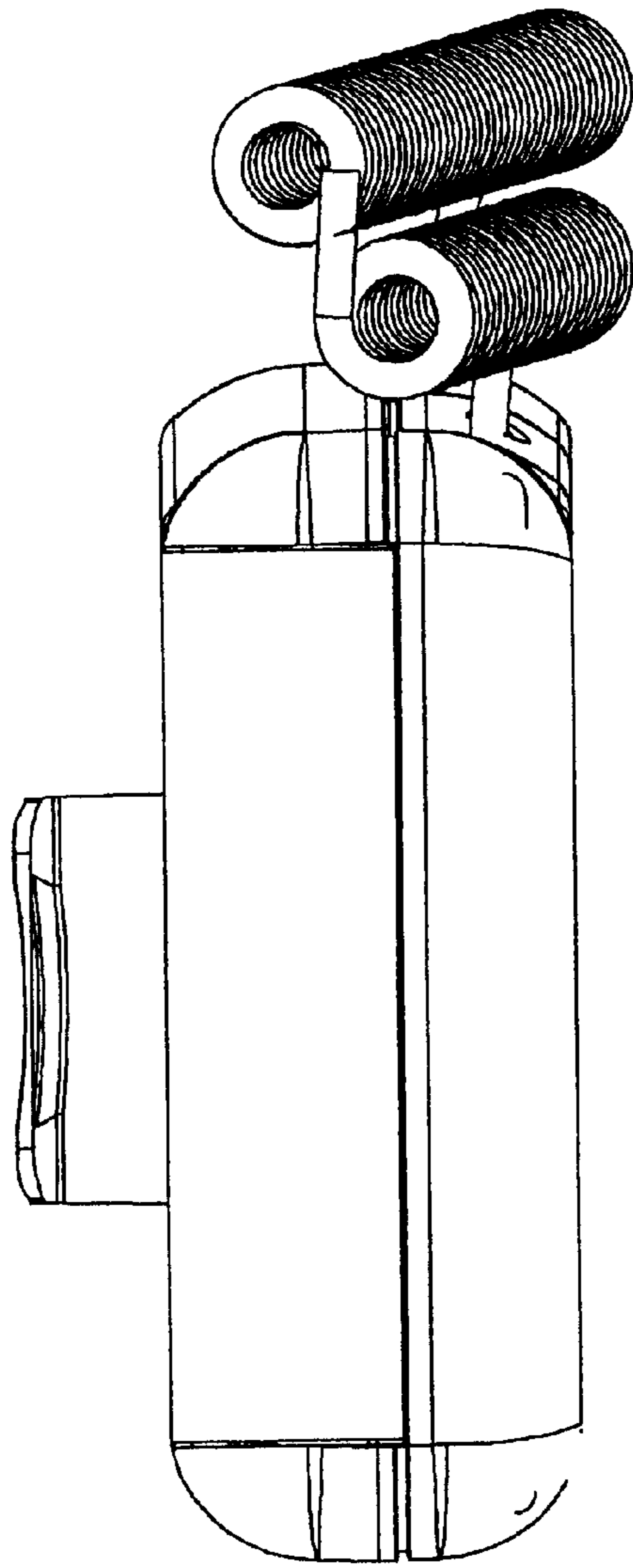

Fig 9