



US00D430760S

United States Patent [19]
Maitland-Smith

[11] **Patent Number: Des. 430,760**

[45] **Date of Patent: ** Sep. 12, 2000**

[54] **TAMBOUR DOOR**

[76] Inventor: **Paul Maitland-Smith**, PIPC Building,
MEPZ, Cebu City, Philippines

[**] Term: **14 Years**

[21] Appl. No.: **29/095,066**

[22] Filed: **Oct. 15, 1998**

[51] **LOC (7) Cl.** **06-04**

[52] **U.S. Cl.** **D6/492; D6/433**

[58] **Field of Search** D6/432-448, 491,
D6/492, 494; 312/204, 257, 297

[56] **References Cited**

U.S. PATENT DOCUMENTS

| | | | | |
|------------|---------|-----------------|-------|--------|
| D. 25,847 | 7/1896 | Coman | | D6/433 |
| D. 177,911 | 6/1956 | Herrmann | | D6/433 |
| D. 178,056 | 6/1956 | Herrmann | | D6/433 |
| D. 181,539 | 11/1957 | Lubberts et al. | | D6/433 |
| D. 370,580 | 6/1996 | Keller et al. | | D6/492 |
| D. 417,099 | 11/1999 | Johnson, Jr. | | D6/492 |

OTHER PUBLICATIONS

Brown Jordan Rattan, p. 36; armoire on page, 1986.
Attached photograph of a tambour door, unknown source,
unknown date, believed to be prior art.

Attached photograph of tambour doors, unknown source,
unknown date, believed to be prior art.

Primary Examiner—Carmen H Vales-Lado
Attorney, Agent, or Firm—Rhodes & Mason, P.L.L.C.

[57] **CLAIM**

The ornamental design for a tambour door, as shown and
described.

DESCRIPTION

FIG. 1 is a front perspective view of a tambour door showing
my new design;

FIG. 2 is a front elevational view thereof;

FIG. 3 is a enlarged detailed view of the top portion of the
door;

FIG. 4 is an enlarged cross-sectional view taken along line
4—4 of FIG. 2;

FIG. 5 is a front perspective view of a second embodiment
of the tambour door shown in FIG. 1; and,

FIG. 6 is a front perspective view of a third embodiment of
the tambour door shown in FIG. 1.

The other sides of the door not shown form no part of the
claimed design. The broken lines shown throughout the
views are for environmental purposes only form no part of
the claimed design.

1 Claim, 3 Drawing Sheets

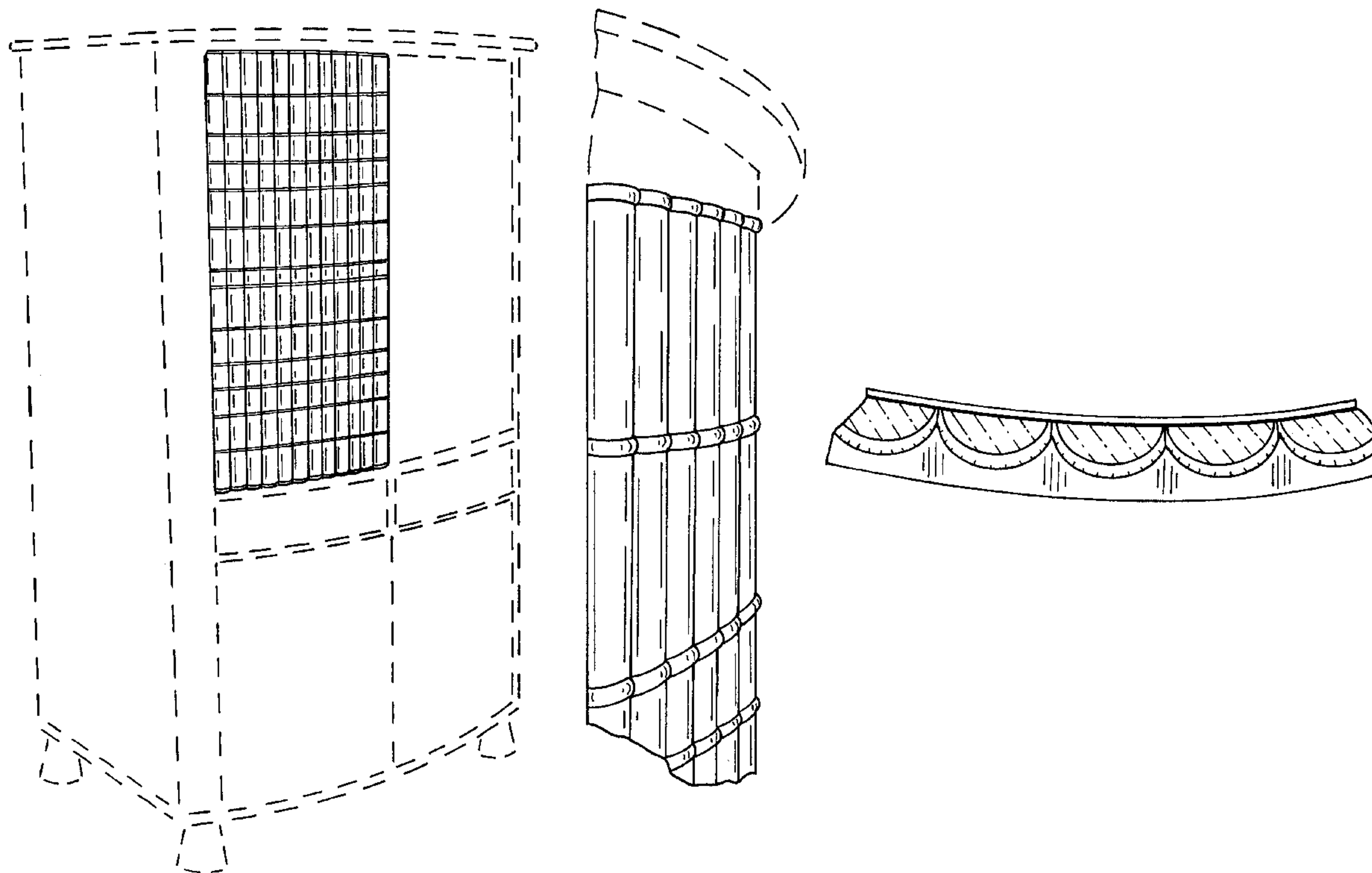

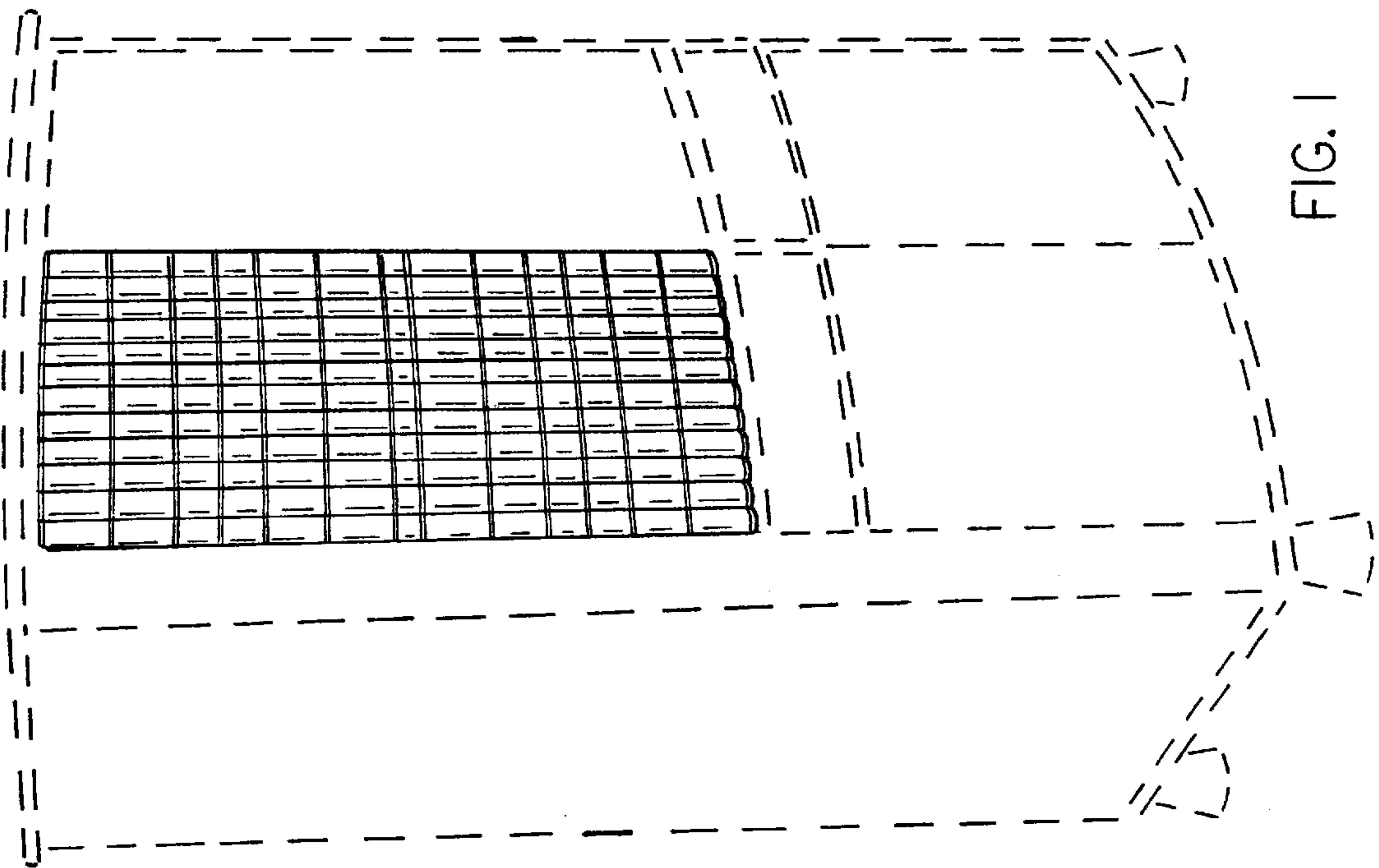
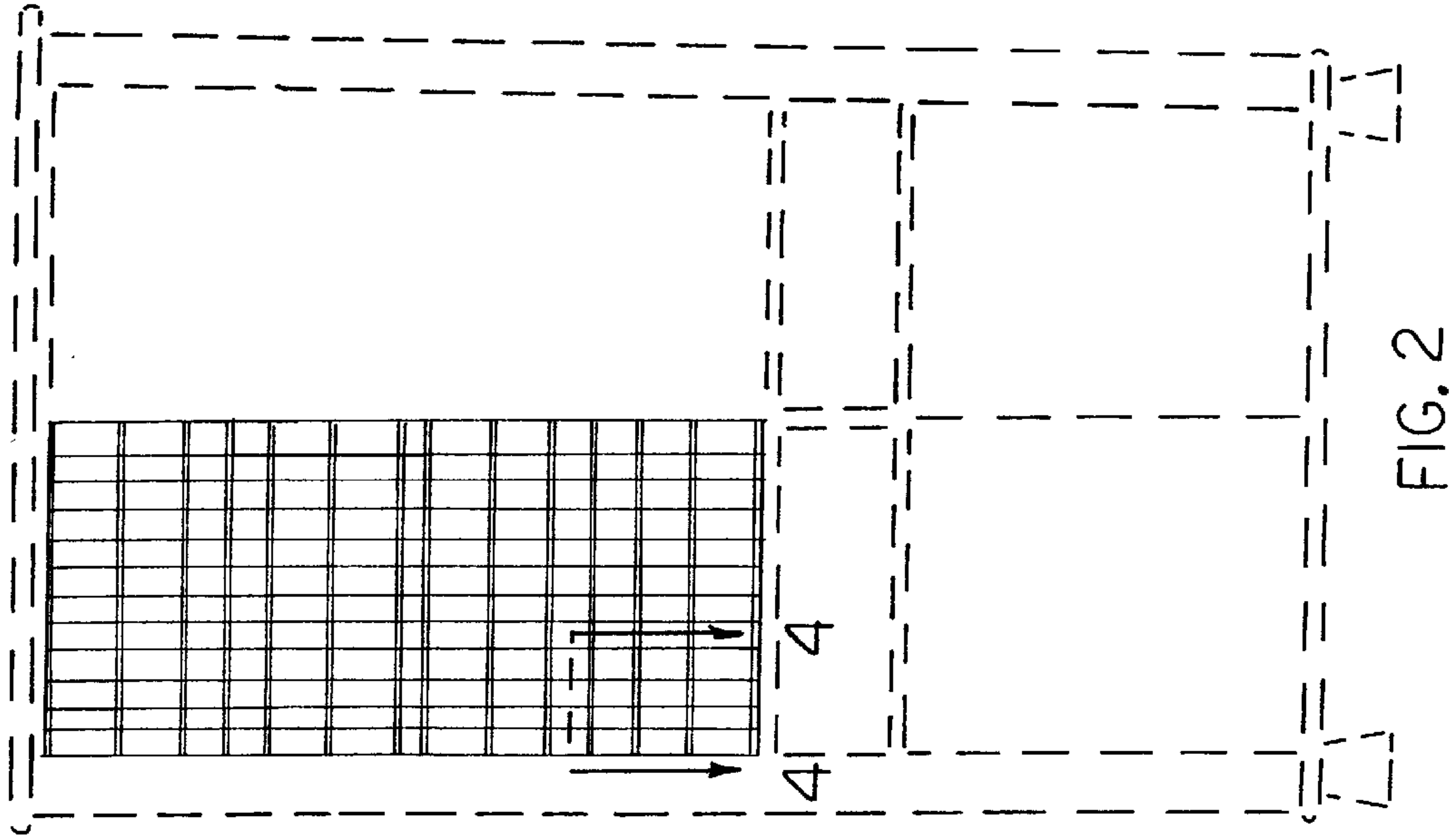

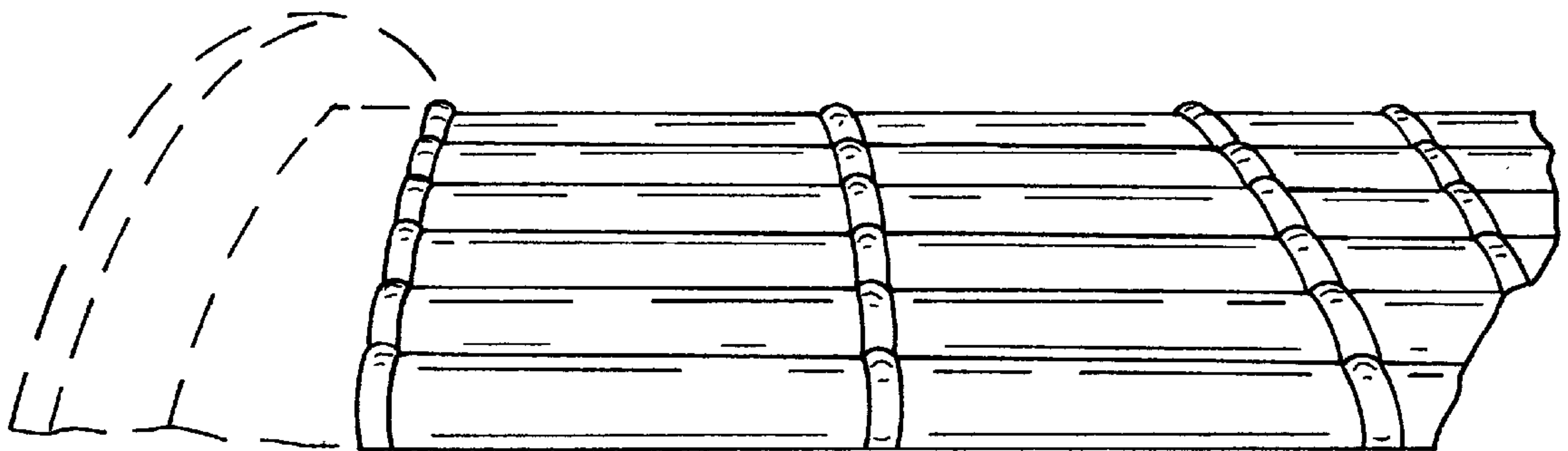

FIG. 3

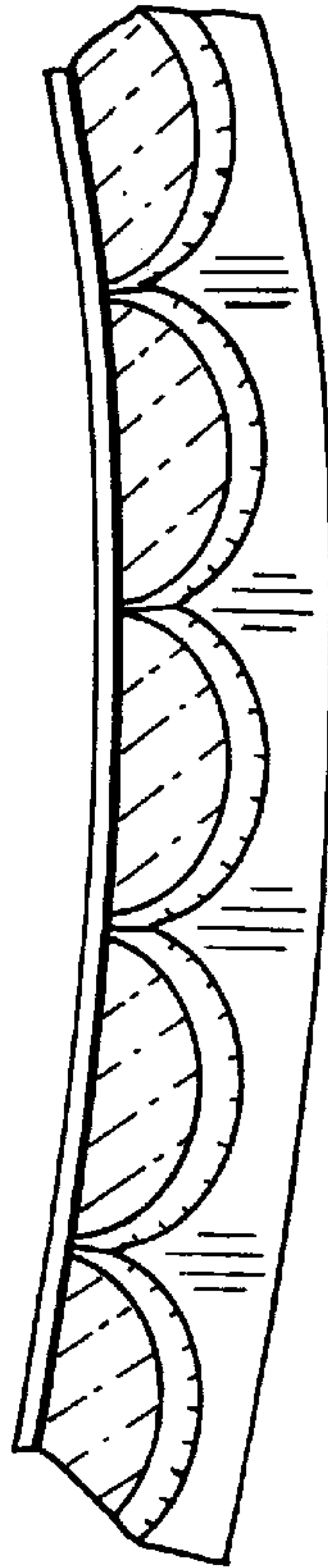

FIG. 4

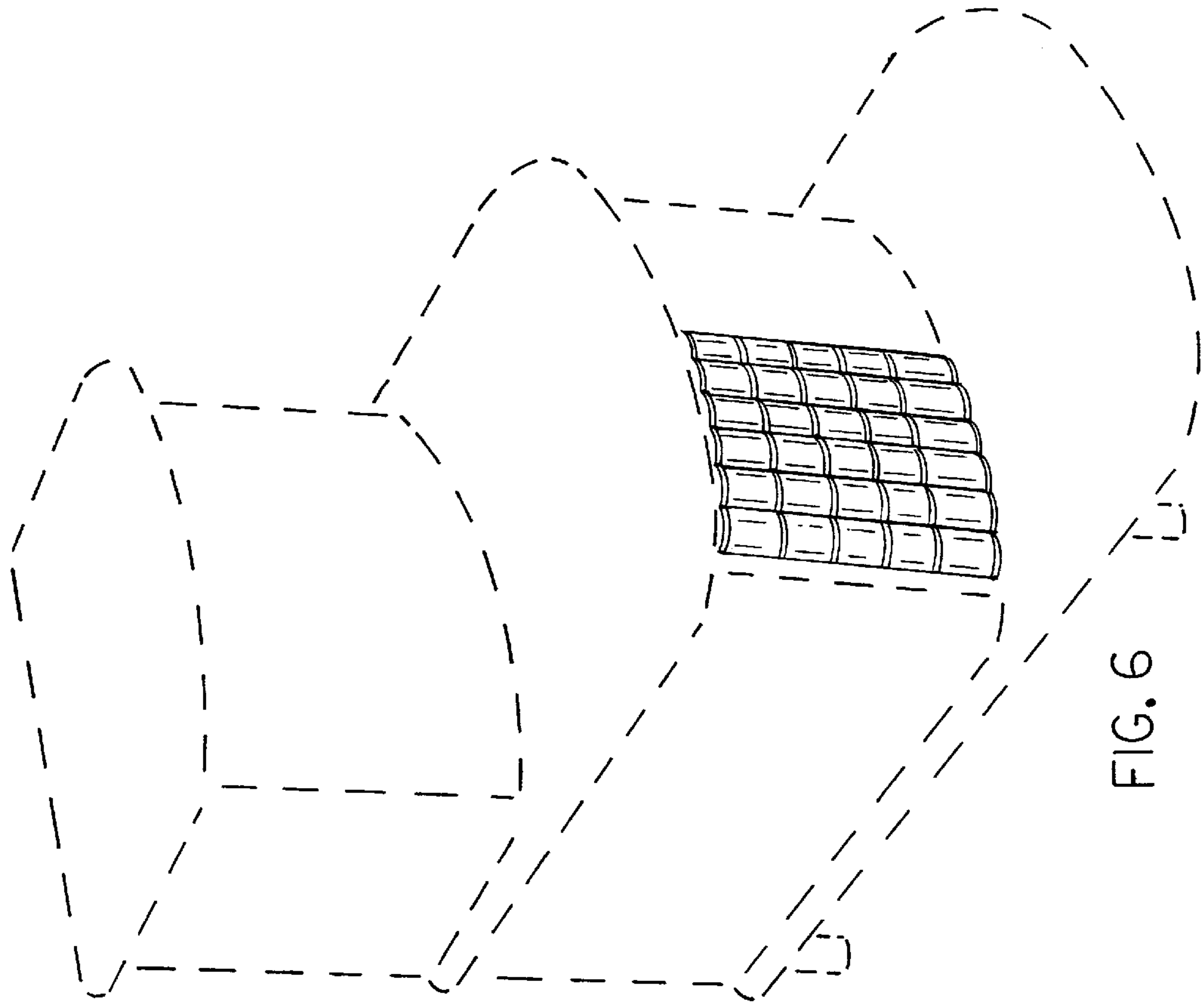

FIG. 6

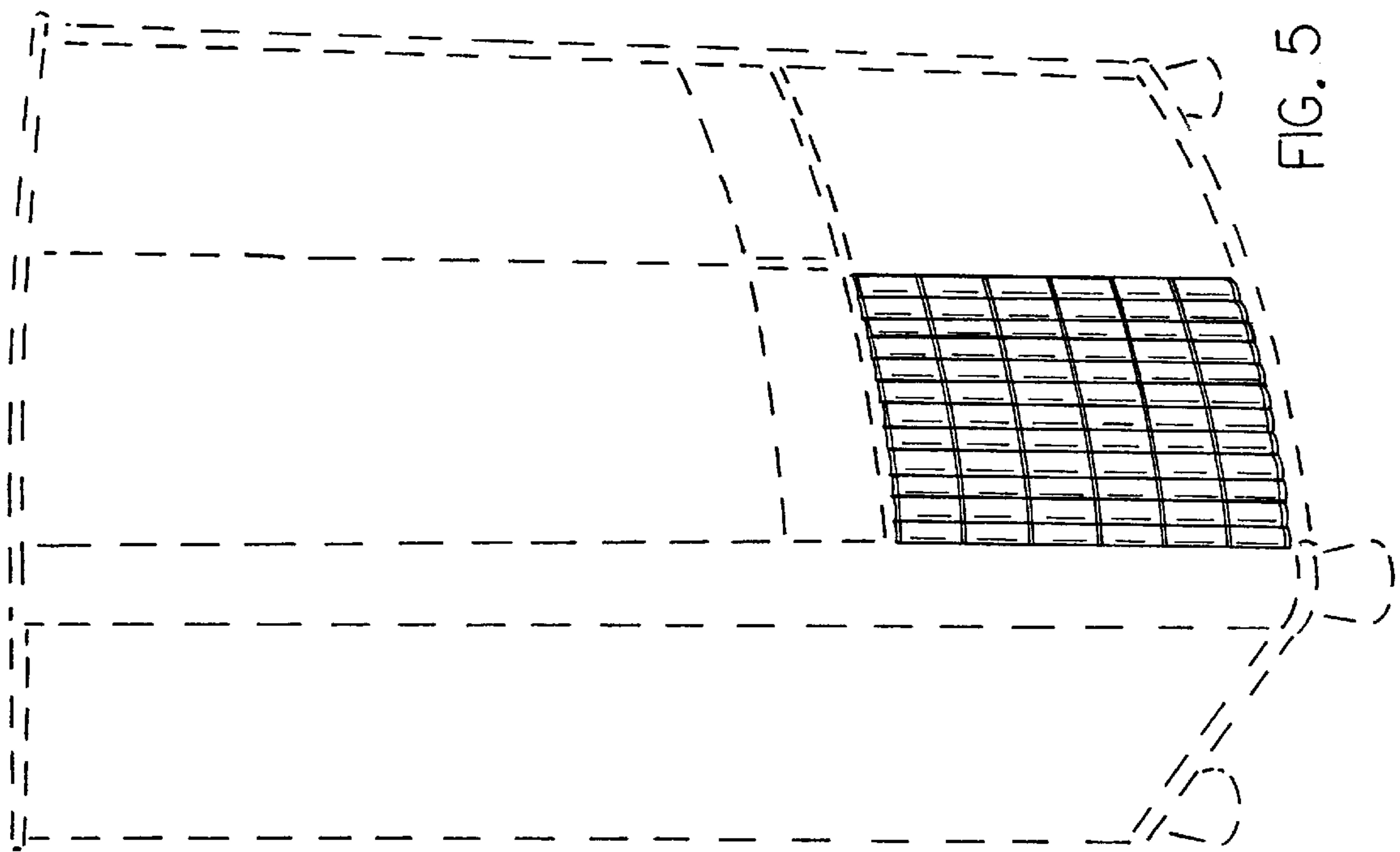

FIG. 5