



US00D430631S

United States Patent [19]
Garcia

[11] **Patent Number: Des. 430,631**

[45] **Date of Patent: ** Sep. 5, 2000**

[54] **GOLF CLUB HEAD**

[76] Inventor: **Larry Garcia**, 4 Martine Ave., White Plains, N.Y. 10606

[**] Term: **14 Years**

[21] Appl. No.: **29/100,296**

[22] Filed: **Feb. 8, 1999**

[51] **LOC (7) Cl.** **21-02**

[52] **U.S. Cl.** **D21/742**

[58] **Field of Search** D21/736-746;
473/251-256, 324, 340, 341, 329-331

[56] **References Cited**

U.S. PATENT DOCUMENTS

D. 300,443	3/1989	Antonious	D21/742
D. 368,751	4/1996	Rife	D21/745
D. 369,393	4/1996	Takahashi et al.	D21/745
D. 378,392	3/1997	Shumway	D21/743
D. 389,208	1/1998	Phillips	D21/739

D. 394,887	6/1998	Bottema	D21/745
D. 397,178	8/1998	Havens et al.	D21/742
5,655,976	8/1997	Rife	473/340
5,683,307	11/1997	Rife	473/350
5,951,412	9/1999	Rose	473/340

Primary Examiner—Mitchell Siegel

[57] **CLAIM**

The ornamental design for a golf club head, as shown.

DESCRIPTION

FIG. 1 is a perspective view of a golf club head showing my new design.

FIG. 2 is a top plan view thereof.

FIG. 3 is a front elevational view thereof.

FIG. 4 is a right elevational view thereof.

FIG. 5 is a left side elevational view thereof.

FIG. 6 is a rear elevational view thereof; and,

FIG. 7 is a bottom plan view thereof.

1 Claim, 2 Drawing Sheets

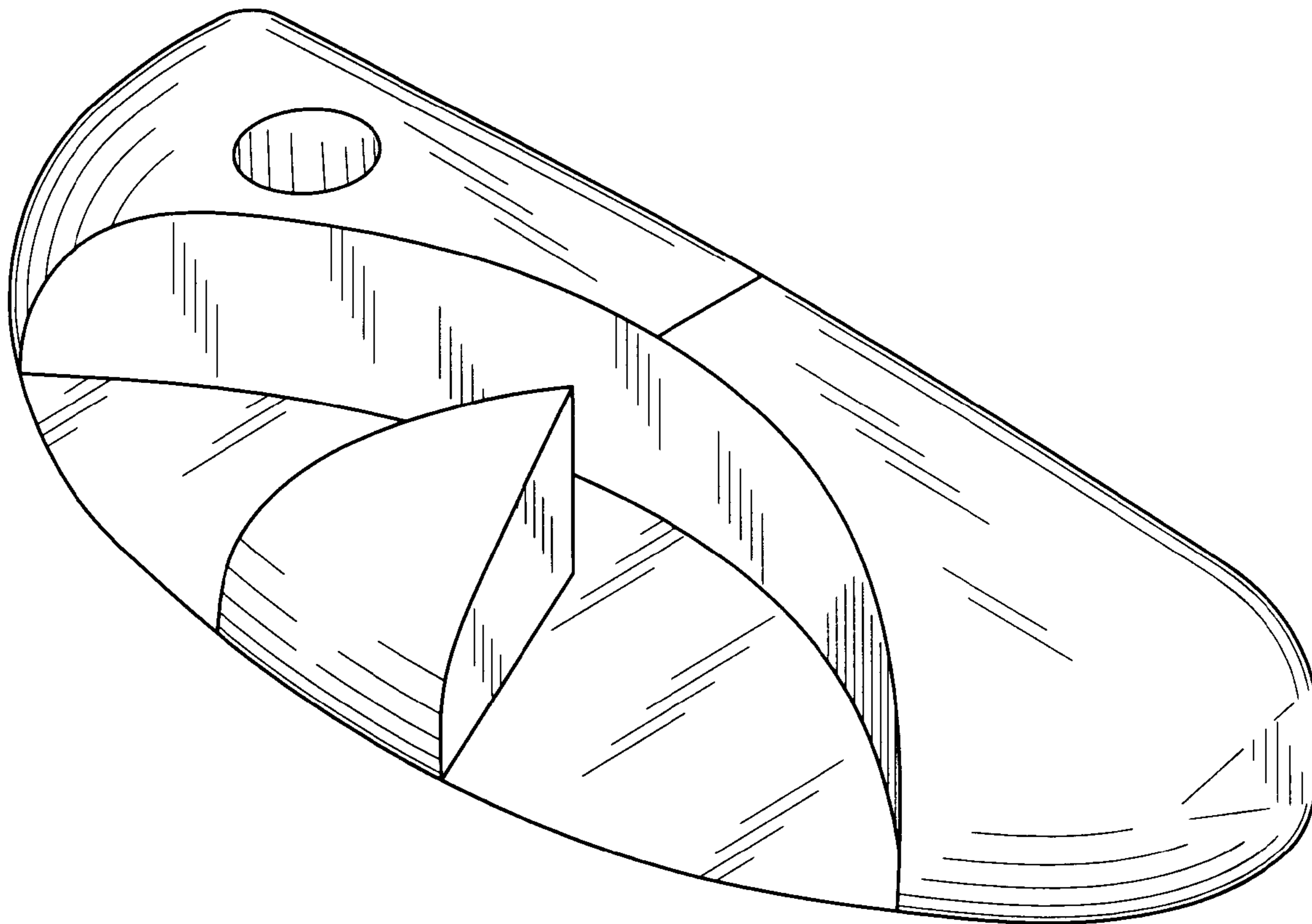

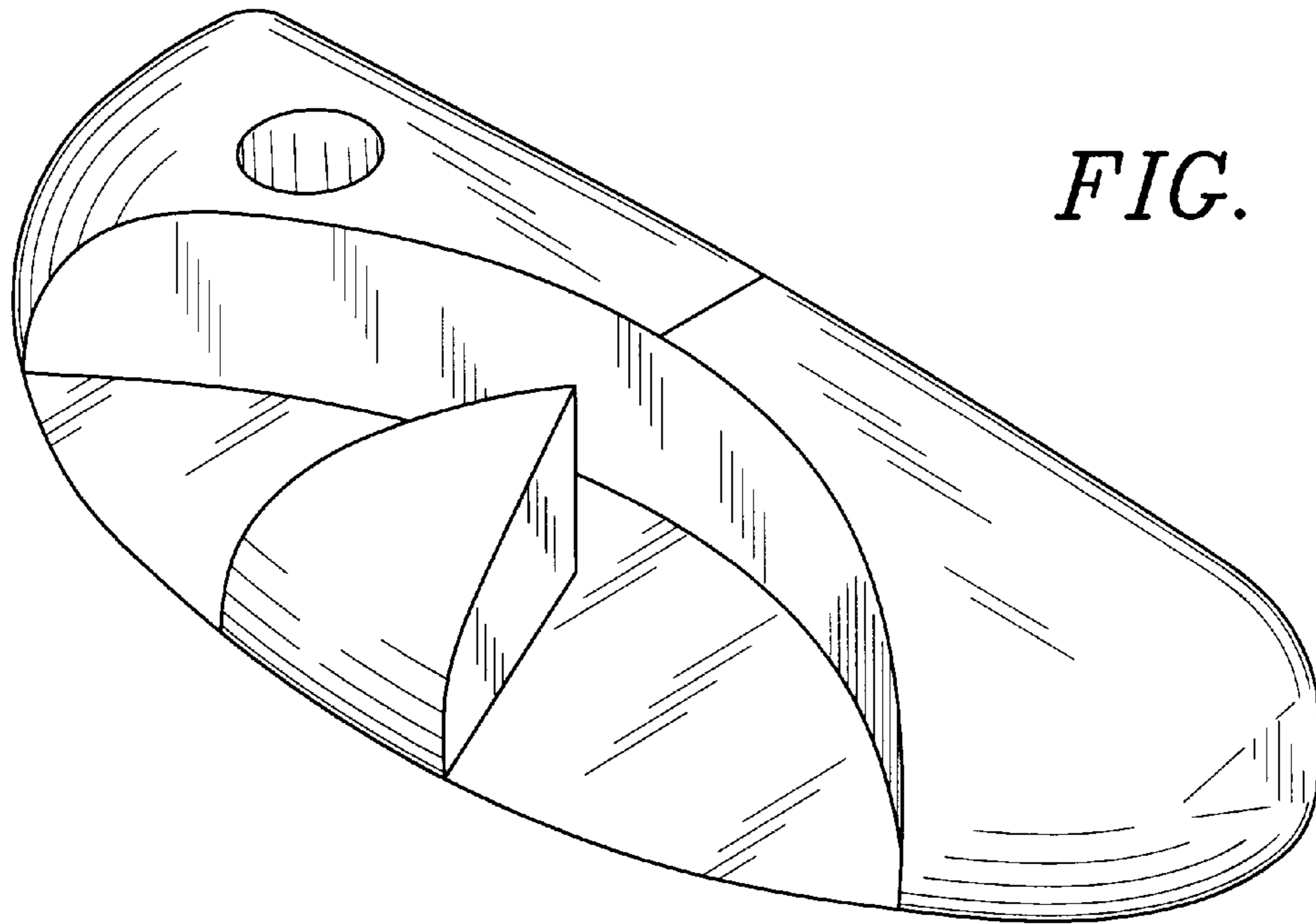

FIG. 1

FIG. 2

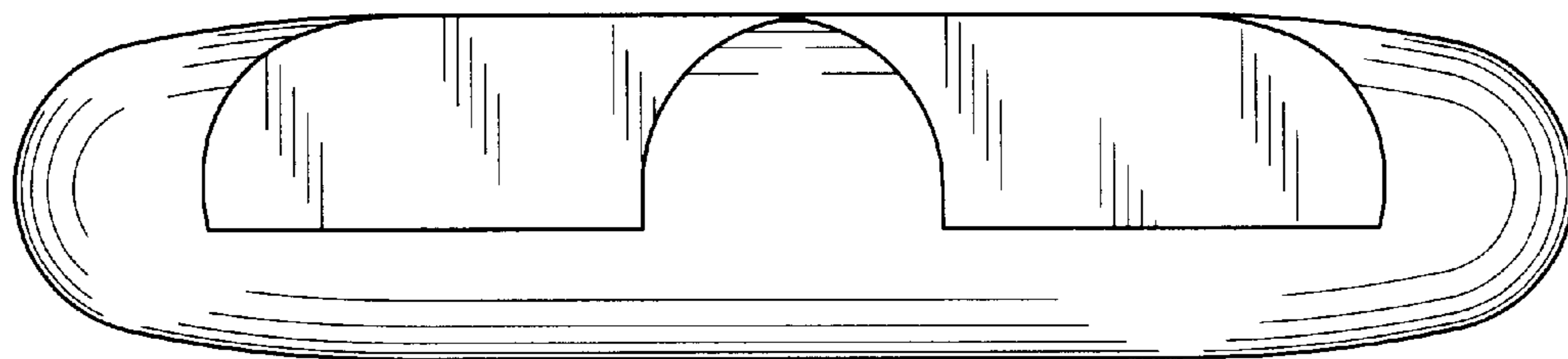
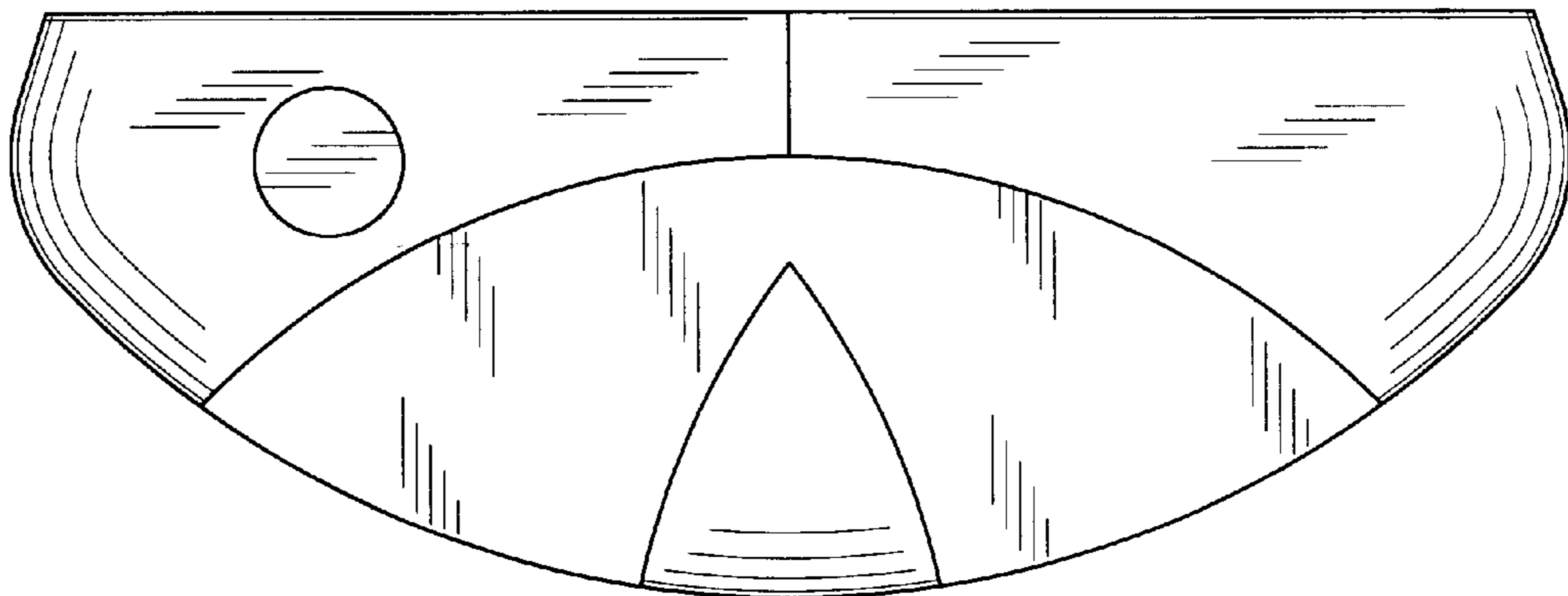

FIG. 6

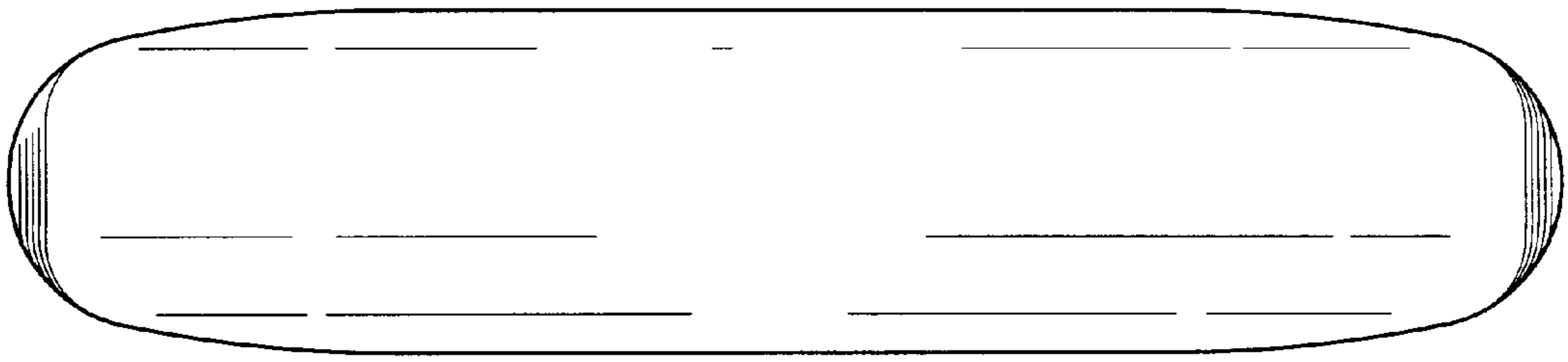

FIG. 3

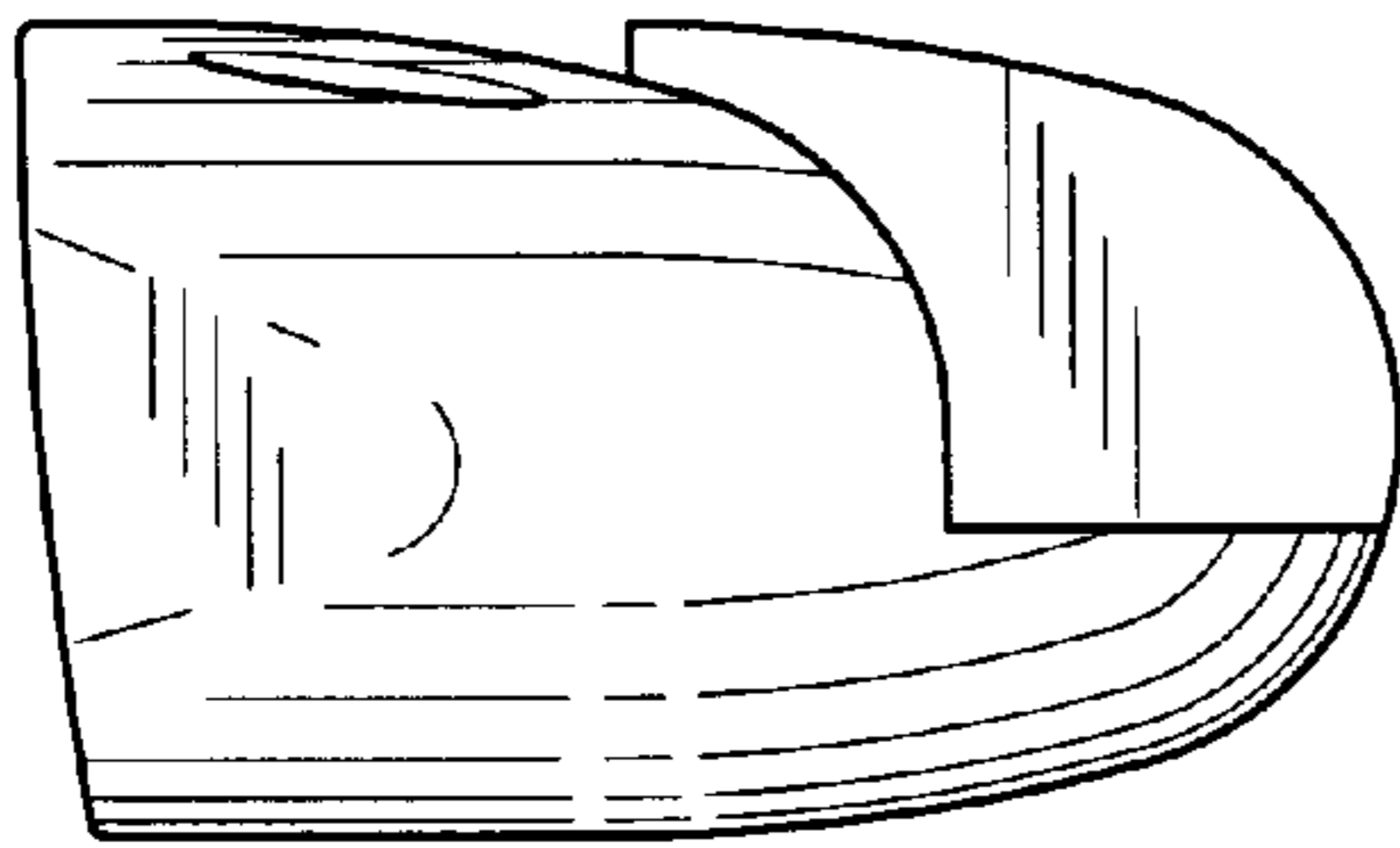

FIG. 4

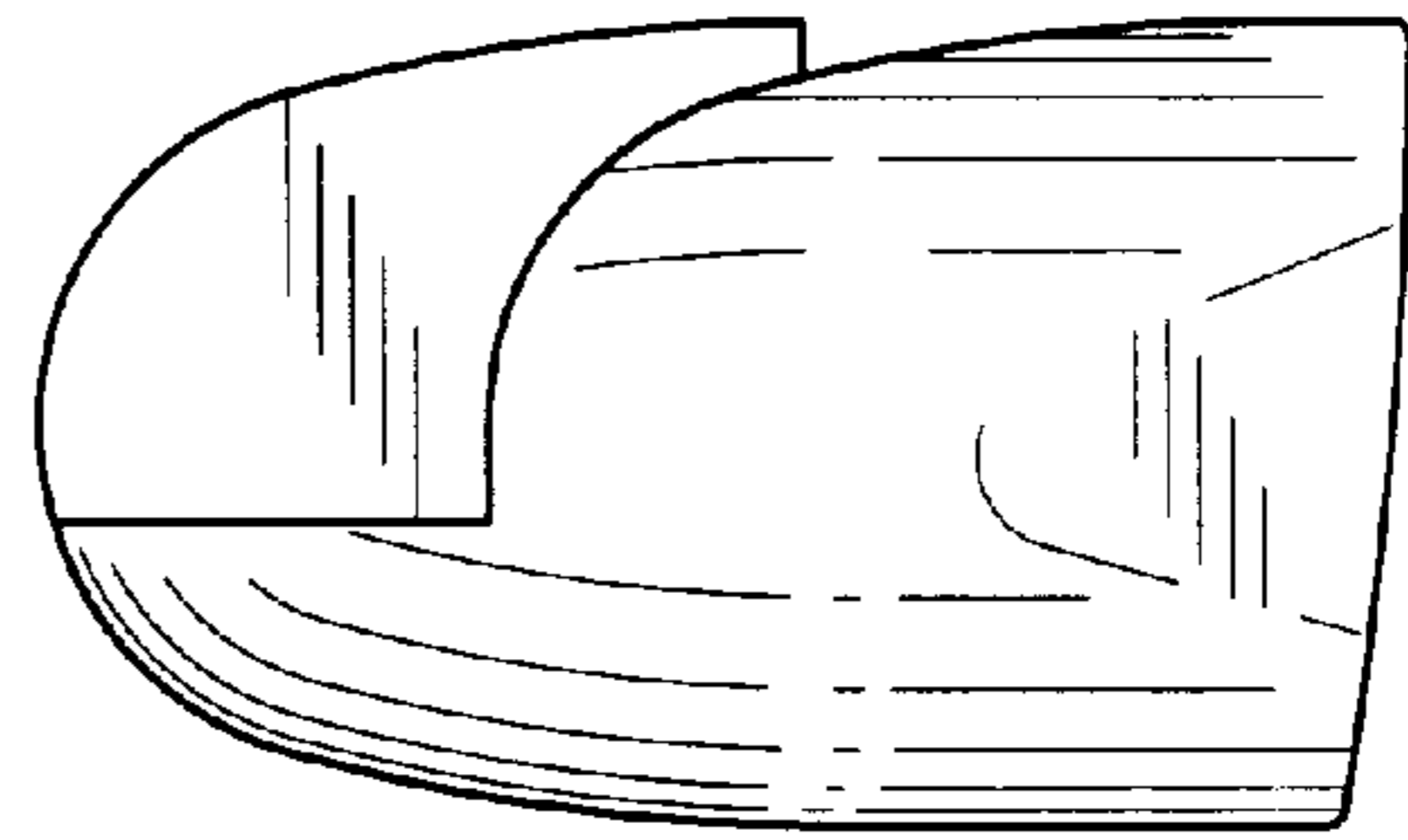

FIG. 5

FIG. 7

