



US00D430602S

United States Patent [19]

Kotaki et al.

[11] Patent Number: Des. 430,602

[45] Date of Patent: ** Sep. 5, 2000

[54] INK TANK FOR PRINTER

[75] Inventors: **Yasuo Kotaki**, Yokohama; **Masashi Ogawa**, Kawasaki; **Tsutomu Abe**, Isehara, all of Japan

[73] Assignee: **Canon Kabushiki Kaisha**, Tokyo, Japan

[**] Term: **14 Years**

[21] Appl. No.: **29/106,435**

[22] Filed: **Jun. 16, 1999**

[30] Foreign Application Priority Data

Dec. 22, 1998 [JP] Japan 10-037293

[51] LOC (7) Cl. **18-02**

[52] U.S. Cl. **D18/56; 347/86**

[58] Field of Search D18/56; 347/86-87

[56] References Cited

U.S. PATENT DOCUMENTS

D. 338,235	8/1993	Komada et al.	D18/56
D. 371,160	6/1996	Kotaki et al.	D18/56
D. 375,120	10/1996	Kotaki et al.	D18/56
D. 376,175	12/1996	Tashiro et al.	D18/56
D. 377,371	1/1997	Tokuda et al.	D18/56
D. 378,526	3/1997	Tashiro et al.	D18/56
D. 378,527	3/1997	Tashiro et al.	D18/56
D. 378,528	3/1997	Tashiro et al.	D18/56
D. 378,529	3/1997	Tashiro et al.	D18/56
D. 378,530	3/1997	Tashiro et al.	D18/56
D. 378,599	3/1997	Tashiro et al.	D18/56
D. 378,600	3/1997	Tashiro et al.	D18/56
D. 378,832	4/1997	Tashiro et al.	D18/56
D. 380,489	7/1997	Tashiro et al.	D18/56

D. 380,490	7/1997	Tashiro et al.	D18/56
D. 380,491	7/1997	Tashiro et al.	D18/56
D. 381,040	7/1997	Tashiro et al.	D18/56
D. 381,680	7/1997	Tashiro et al.	D18/56
D. 382,895	8/1997	Tashiro et al.	D18/56
D. 383,158	9/1997	Tashiro et al.	D18/56
D. 384,371	9/1997	Tashiro et al.	D18/56
D. 385,909	11/1997	Tashiro et al.	D18/56
D. 386,203	11/1997	Tashiro et al.	D18/56
D. 386,520	11/1997	Tashiro et al.	D18/56
D. 390,869	2/1998	Tashiro et al.	D18/56
D. 390,870	2/1998	Tashiro et al.	D18/56
D. 395,446	6/1998	Tashiro et al.	D18/56
D. 400,574	11/1998	Inoue et al.	D18/56
D. 401,620	11/1998	Nozawa et al.	D18/56
D. 401,621	11/1998	Shimizu et al.	D18/56
D. 404,067	1/1999	Tashiro et al.	D18/56
D. 407,746	4/1999	Fujii et al.	D18/56

Primary Examiner—Cathy Anne MacCormac
Attorney, Agent, or Firm—Fitzpatrick, Cella, Harper & Scinto

[57] CLAIM

The ornamental design for an ink tank for printer, as shown and described.

DESCRIPTION

FIG. 1 is a front view of an ink tank for printer showing our new design;
FIG. 2 is a rear view thereof;
FIG. 3 is a top plan view thereof;
FIG. 4 is a bottom plan view thereof;
FIG. 5 is a left side view thereof;
FIG. 6 is a right side view thereof; and,
FIG. 7 is a perspective view thereof.

1 Claim, 4 Drawing Sheets

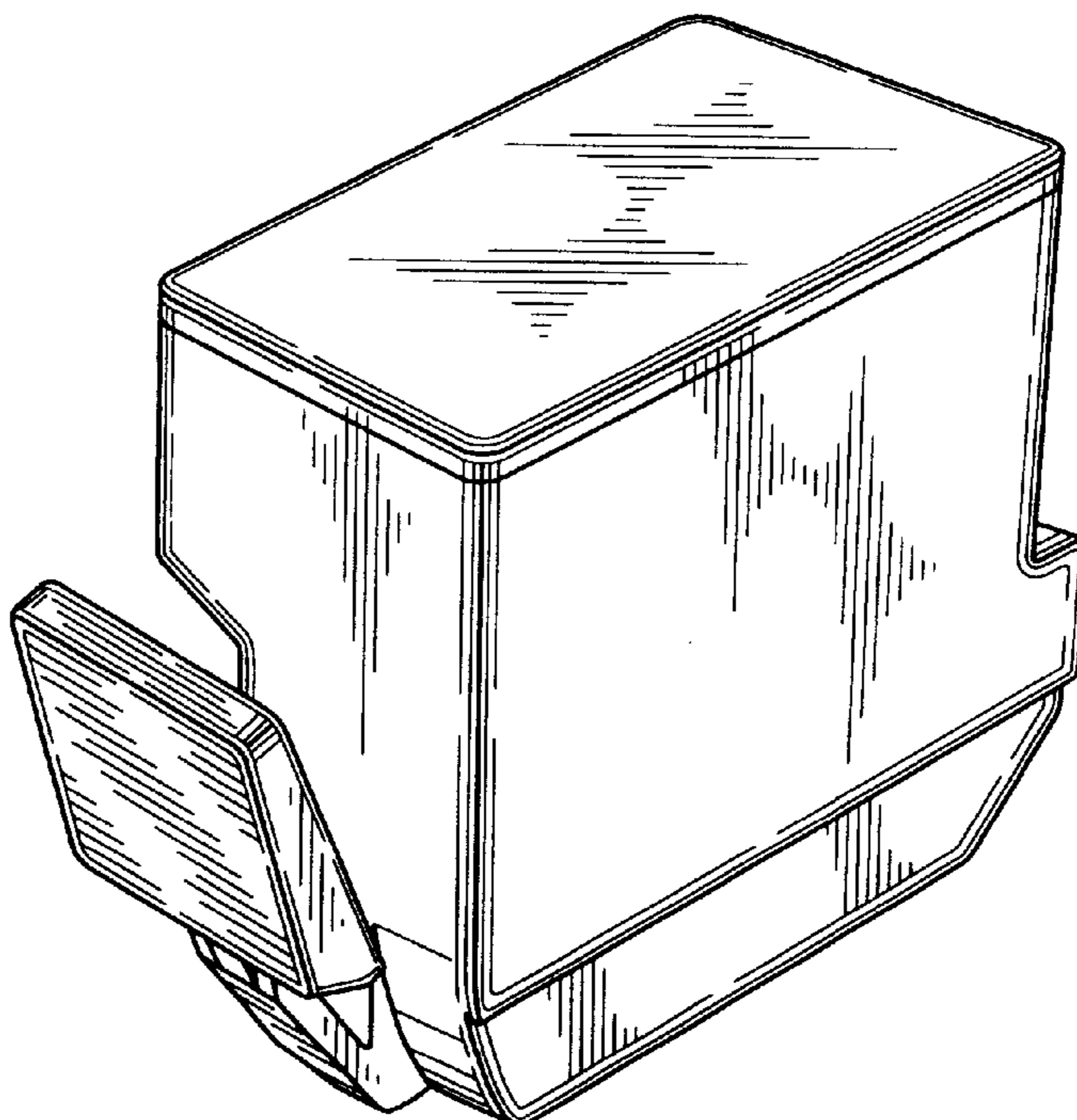

FIG. 1

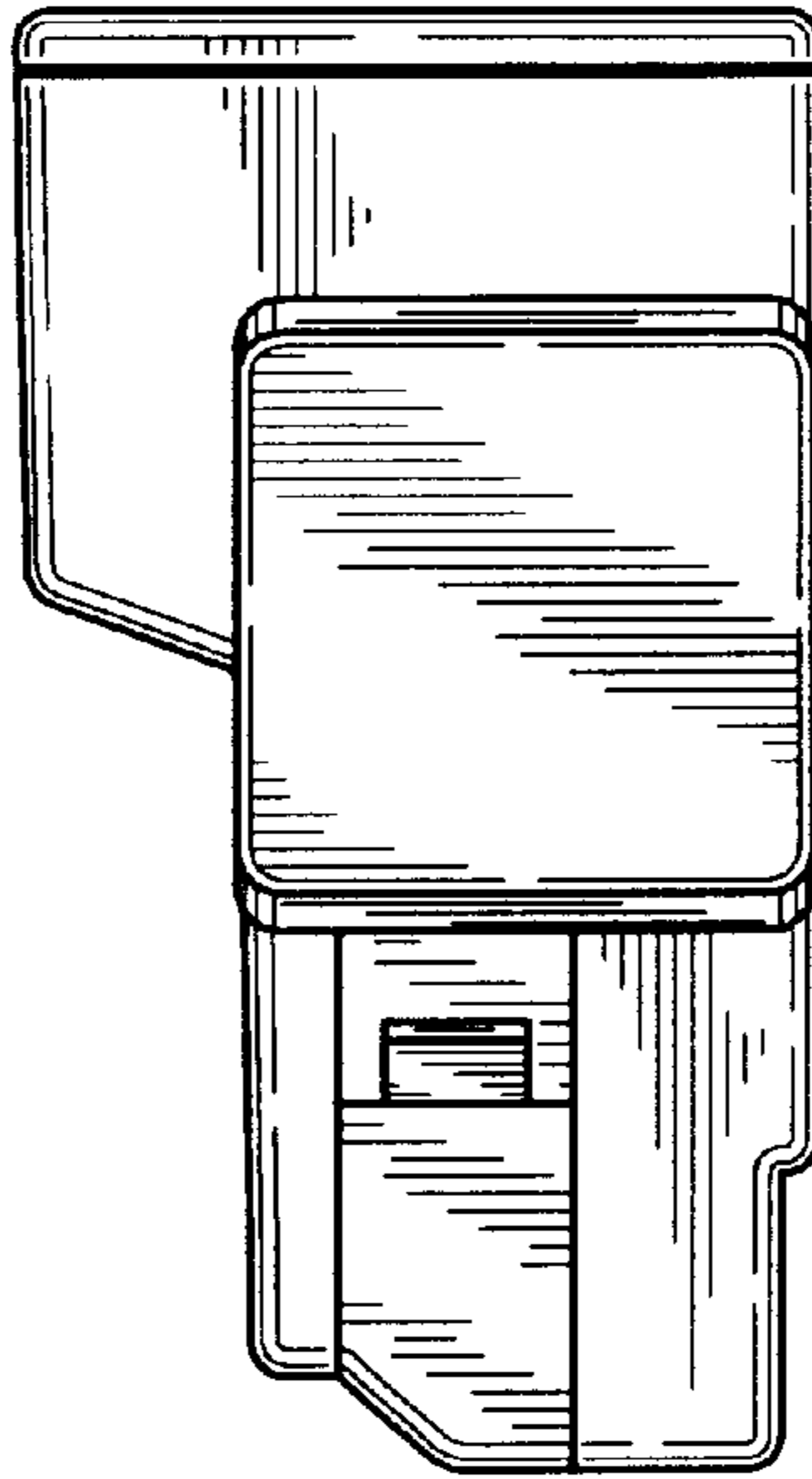

FIG. 2

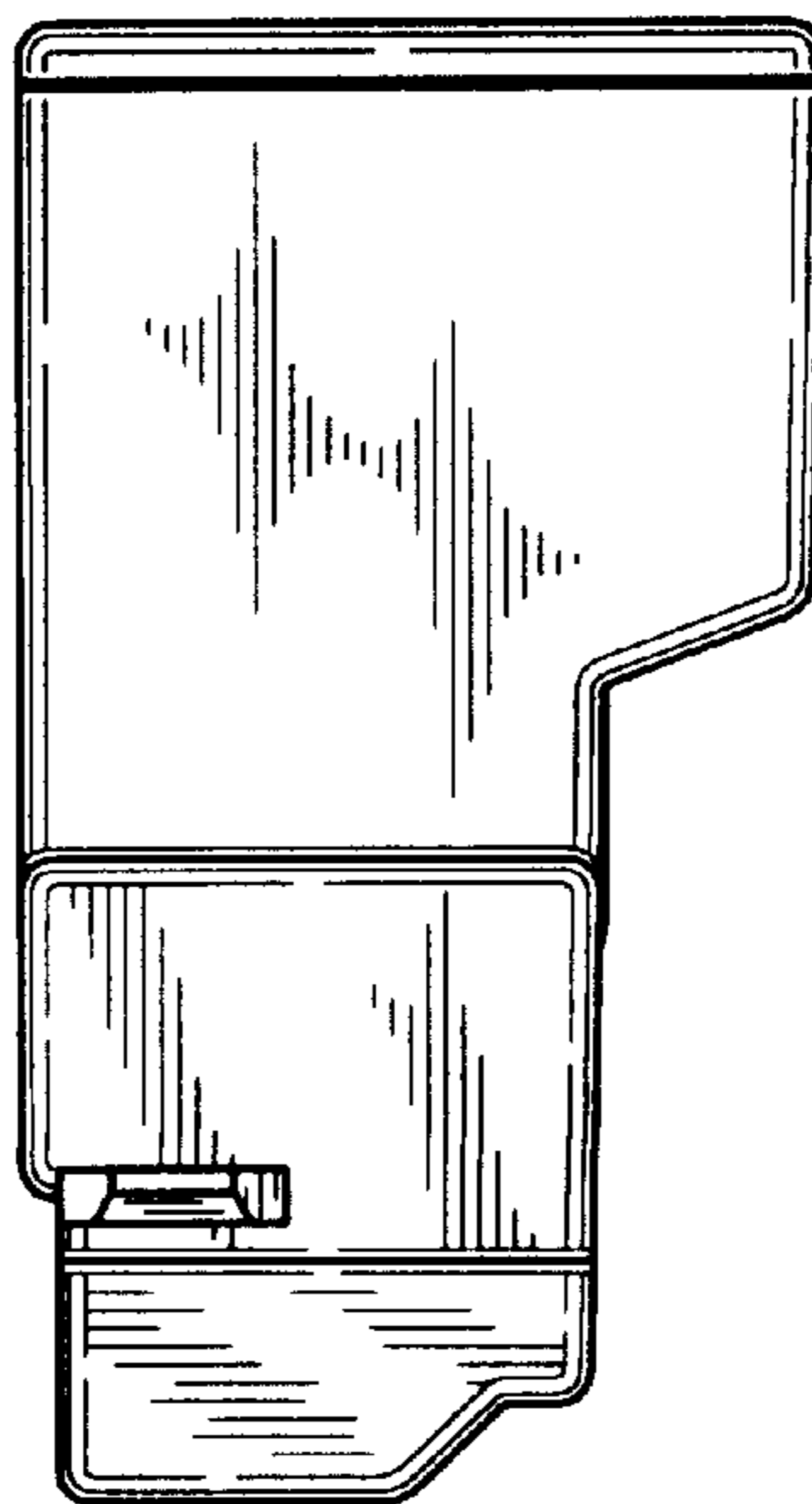

FIG. 3

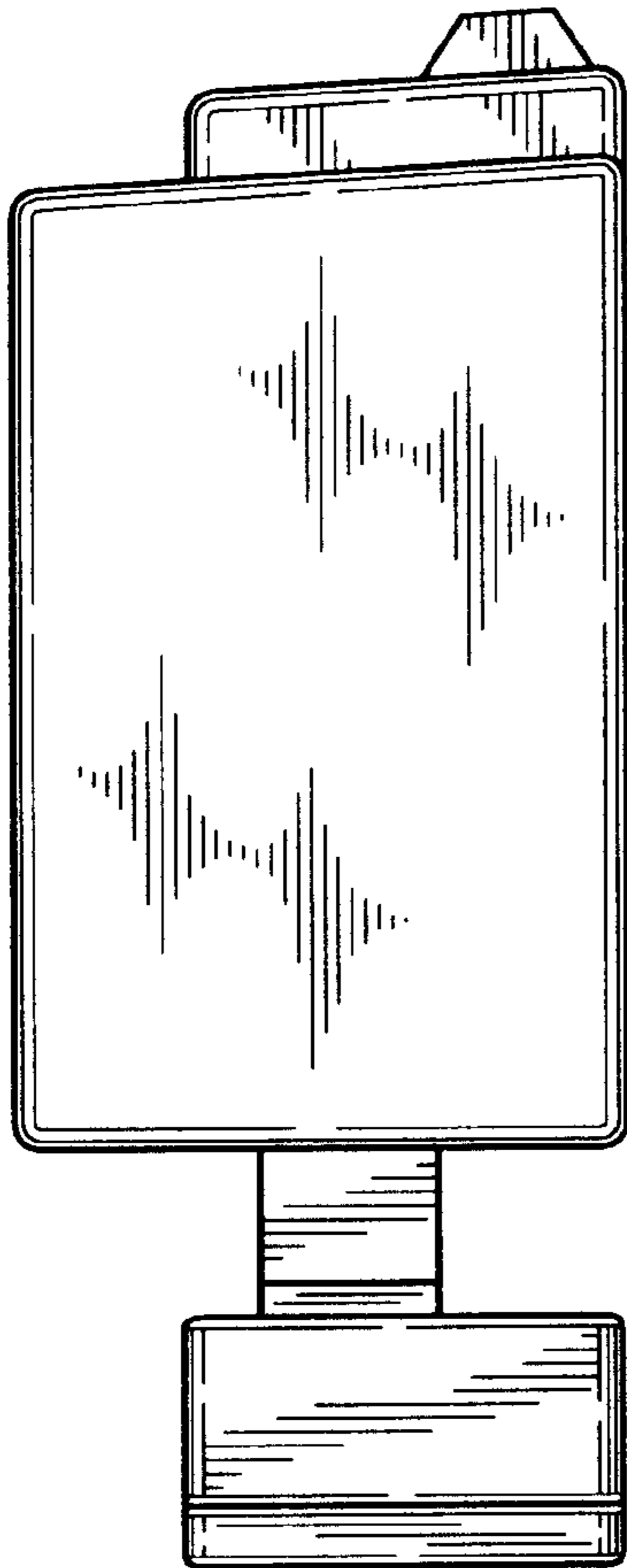

FIG. 4

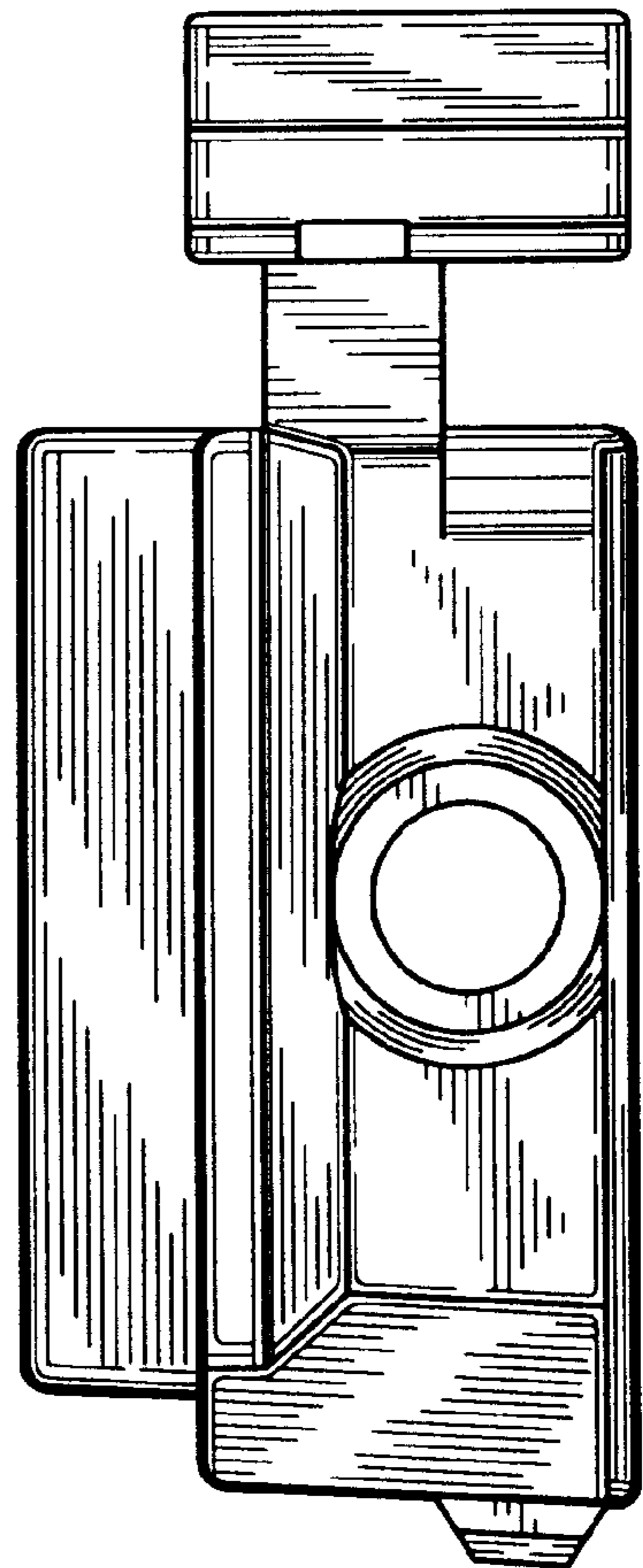

FIG. 5

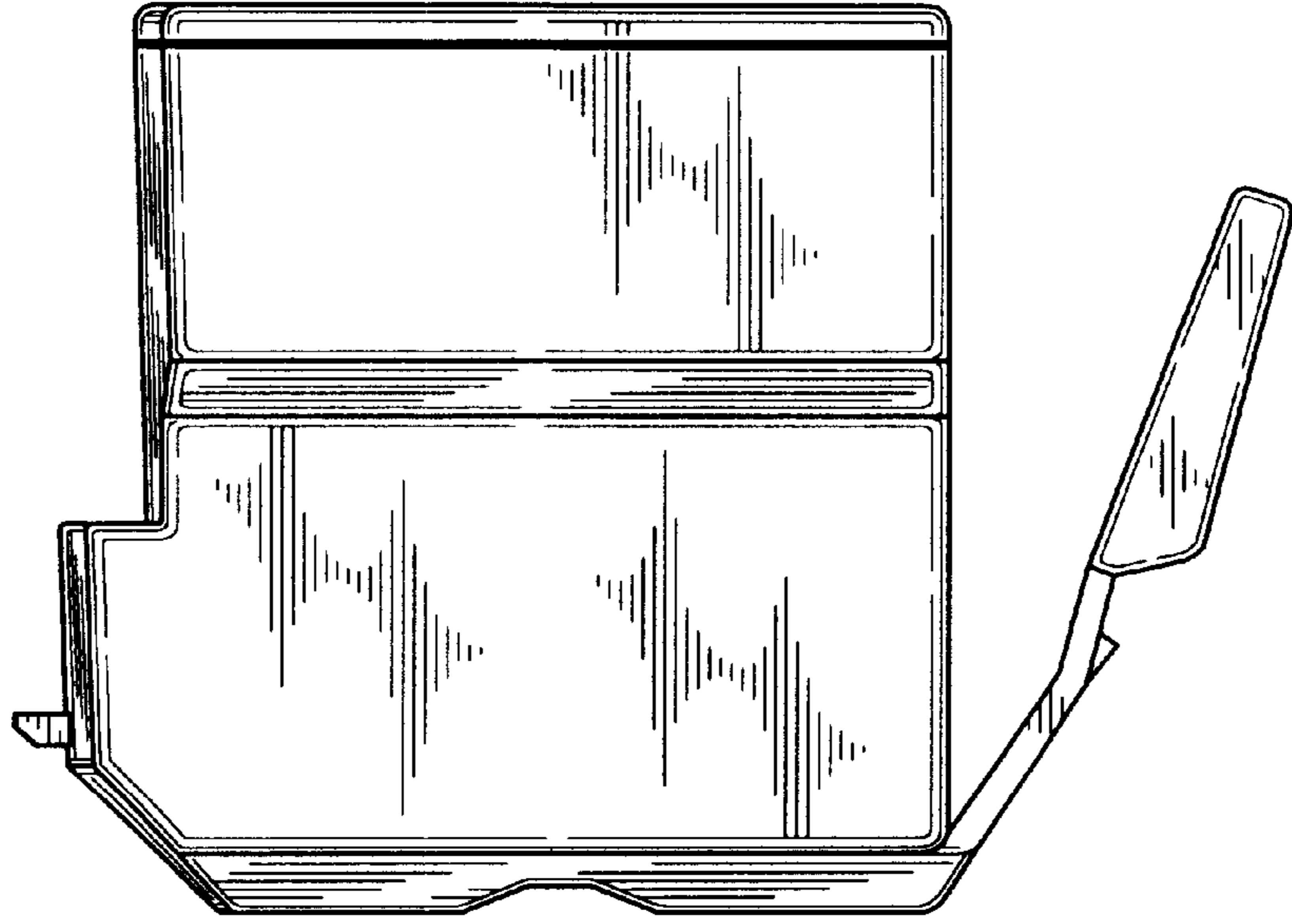

FIG. 6

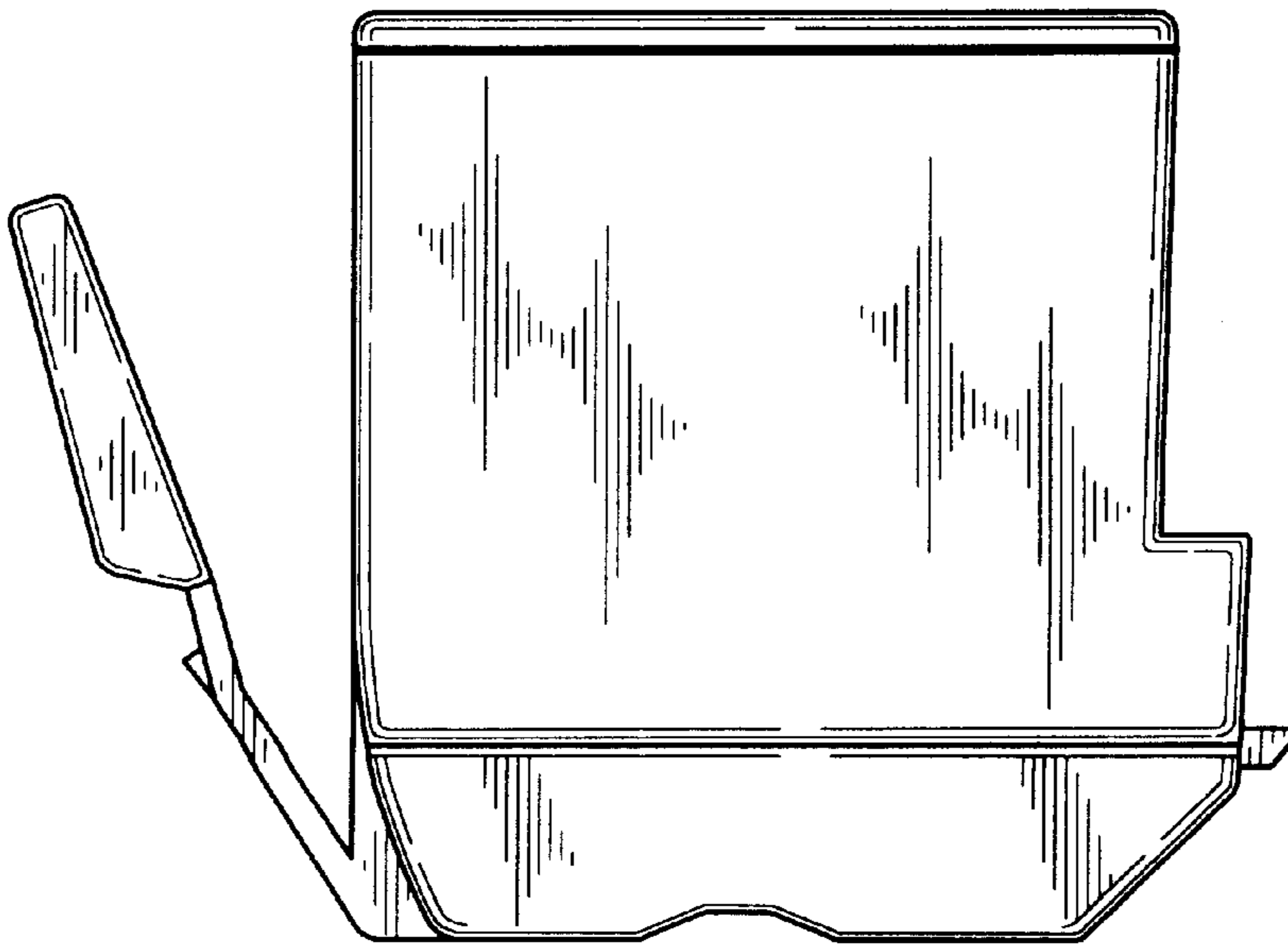

FIG. 7

