



US00D430560S

United States Patent [19] Carazon Climent

[11] **Patent Number: Des. 430,560**
[45] **Date of Patent: ** Sep. 5, 2000**

[54] **TELEPHONE HANDSET**

[75] Inventor: **Alberto Carazon Climent**, Madrid, Spain

[73] Assignee: **Telefonica S.A.**, Madrid, Spain

[**] Term: **14 Years**

[21] Appl. No.: **29/110,628**

[22] Filed: **Sep. 10, 1999**

Related U.S. Application Data

[62] Division of application No. 29/096,644, Nov. 17, 1998, Pat. No. Des. 418,835.

Foreign Application Priority Data

May 22, 1998 [ES] Spain 142818

[51] **LOC (7) Cl.** **14-03**

[52] **U.S. Cl.** **D14/248**

[58] **Field of Search** D14/137, 248,
D14/138, 101, 148, 147, 149-151, 140-142,
240, 241; 379/433-436, 419, 420, 440;
455/550-575, 90

References Cited

U.S. PATENT DOCUMENTS

- D. 196,298 9/1963 Stevens .
- D. 263,049 2/1982 Cobb D14/248
- D. 279,004 5/1985 Ryan D14/248
- D. 284,858 7/1986 Kao D14/248
- D. 288,442 2/1987 Brown D14/248
- D. 291,561 8/1987 Nozawa et al. .
- D. 292,919 11/1987 Lagerbielke et al. .
- D. 295,172 4/1988 Smith et al. .

- D. 299,027 12/1988 Boykiw D14/248
- D. 300,319 3/1989 Stockholm et al. .
- D. 301,146 5/1989 Jackwicz et al. D14/248
- D. 303,386 9/1989 Iino .
- D. 307,427 4/1990 Polhemus .
- D. 323,164 1/1992 Myoga .
- D. 325,031 3/1992 Chan .
- D. 325,909 5/1992 Shambley et al. D14/138
- D. 344,525 2/1994 Gillett et al. D14/248
- D. 354,055 1/1995 Nagele et al. D14/138
- D. 359,283 6/1995 Rudkiewicz D14/149
- D. 363,290 10/1995 Kim D14/248
- D. 371,782 7/1996 Béhar et al. .
- D. 377,024 12/1996 Andrea D14/218
- D. 381,980 8/1997 Andrea D14/148
- D. 389,833 1/1998 Bijksstra .
- 4,773,091 9/1988 Busche et al. 379/433
- 4,776,009 10/1988 Gumb et al. 379/433

Primary Examiner—Jeffrey Asch
Attorney, Agent, or Firm—Jacobson, Price, Holman & Stern, PLLC

[57] CLAIM

The ornamental design for a telephone handset, as shown and described.

DESCRIPTION

FIG. 1 is a front elevational view of my new telephone handset design;
FIG. 2 is a left side elevational view of the handset of FIG. 1;
FIG. 3 is a rear view of the handset of FIG. 1;
FIG. 4 is a right side elevational view of the handset of FIG. 1;
FIG. 5 is a top view of the handset of FIG. 1; and,
FIG. 6 is a bottom view of the handset of FIG. 1;

1 Claim, 2 Drawing Sheets

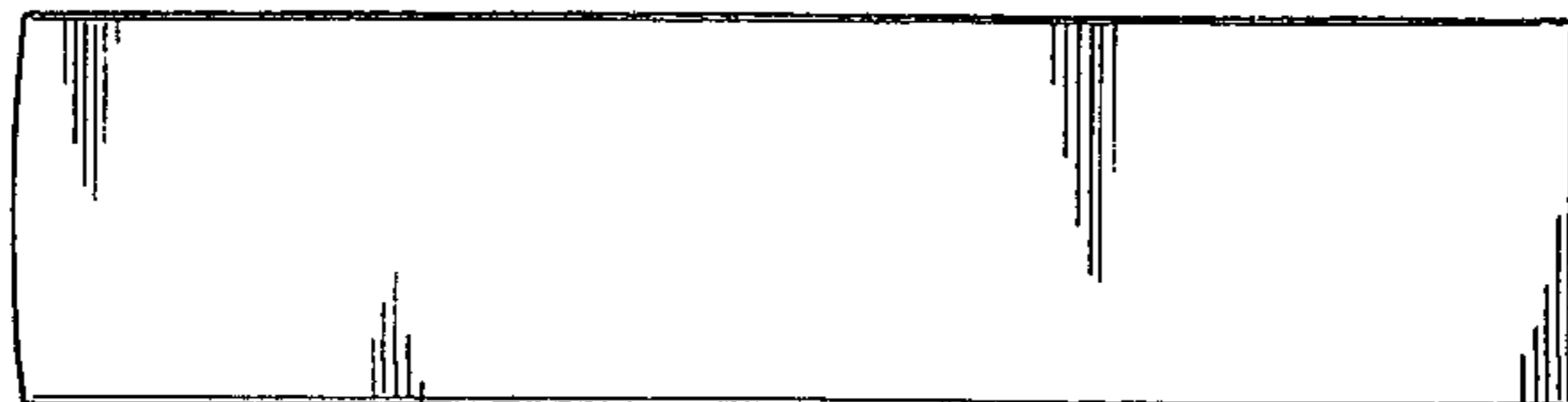
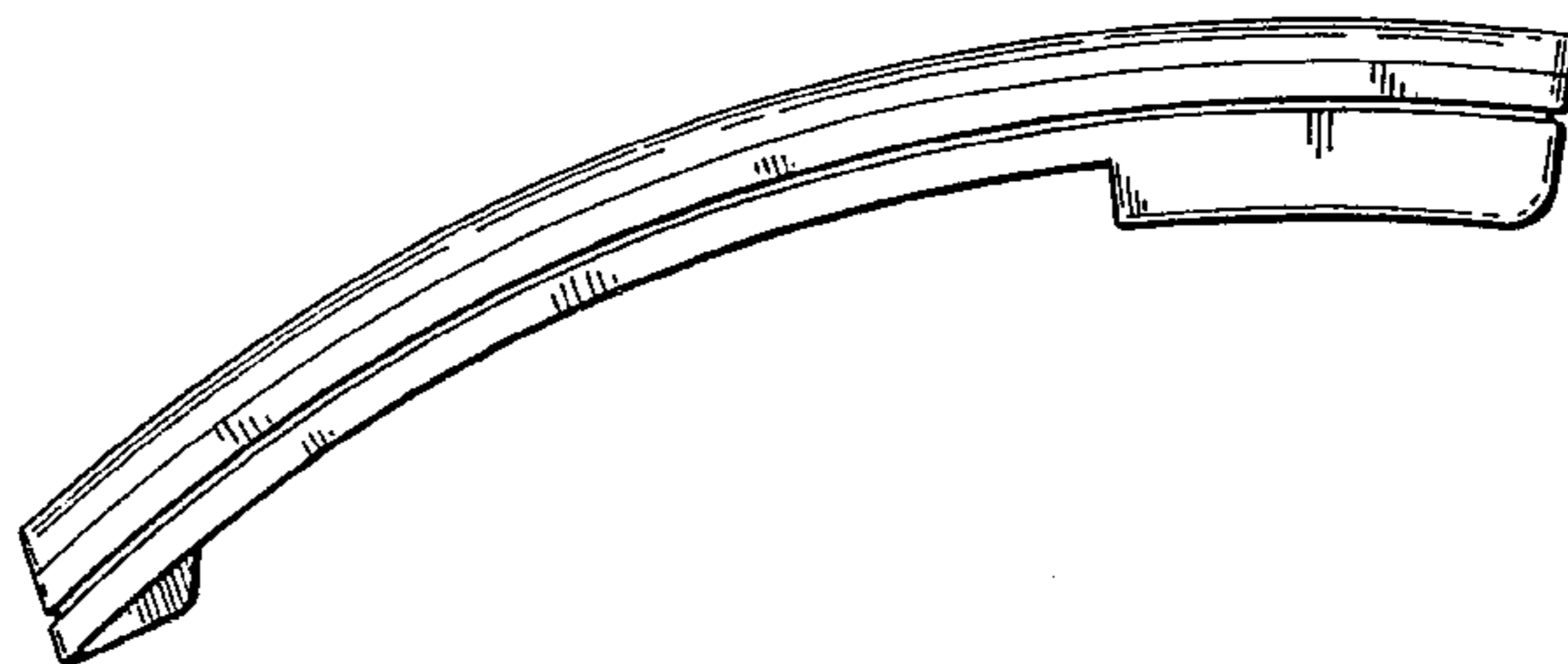
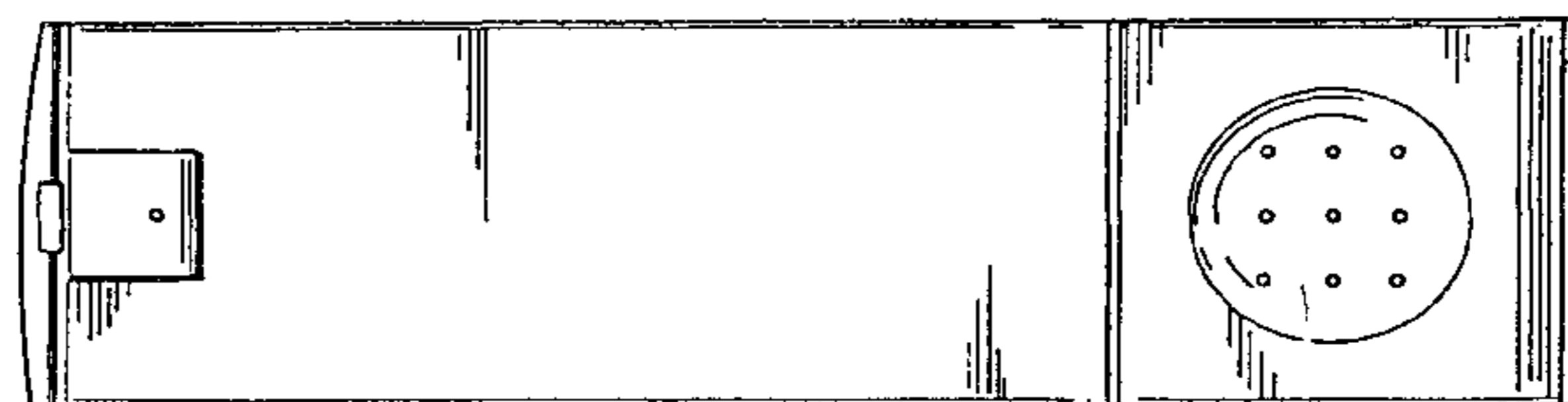

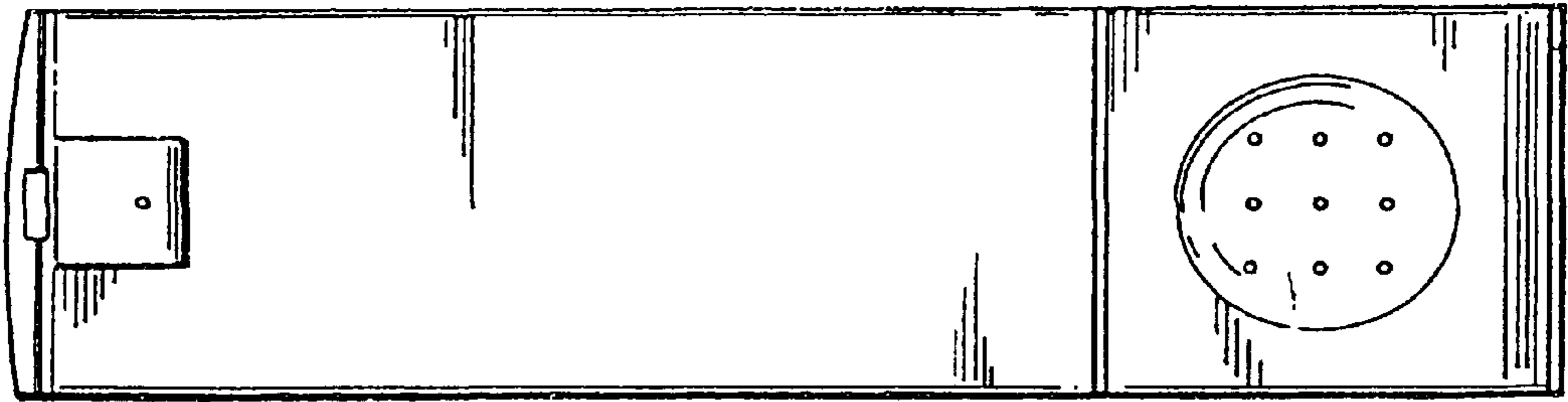

FIG. 1

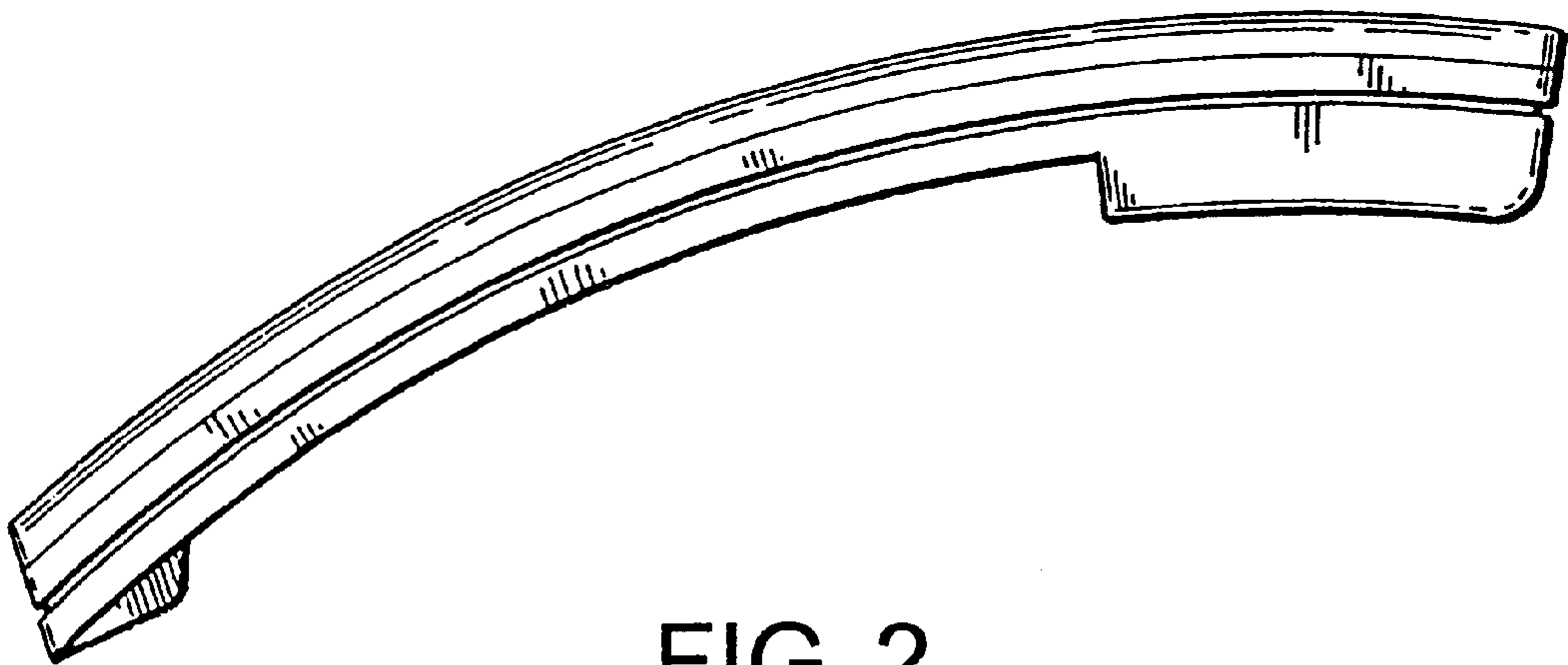

FIG. 2

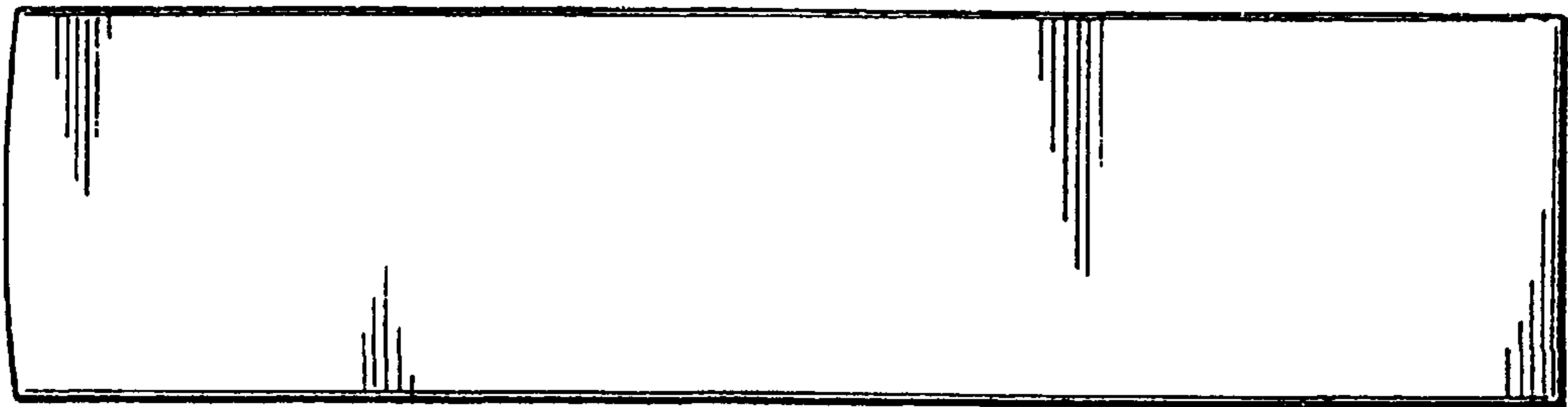

FIG. 3

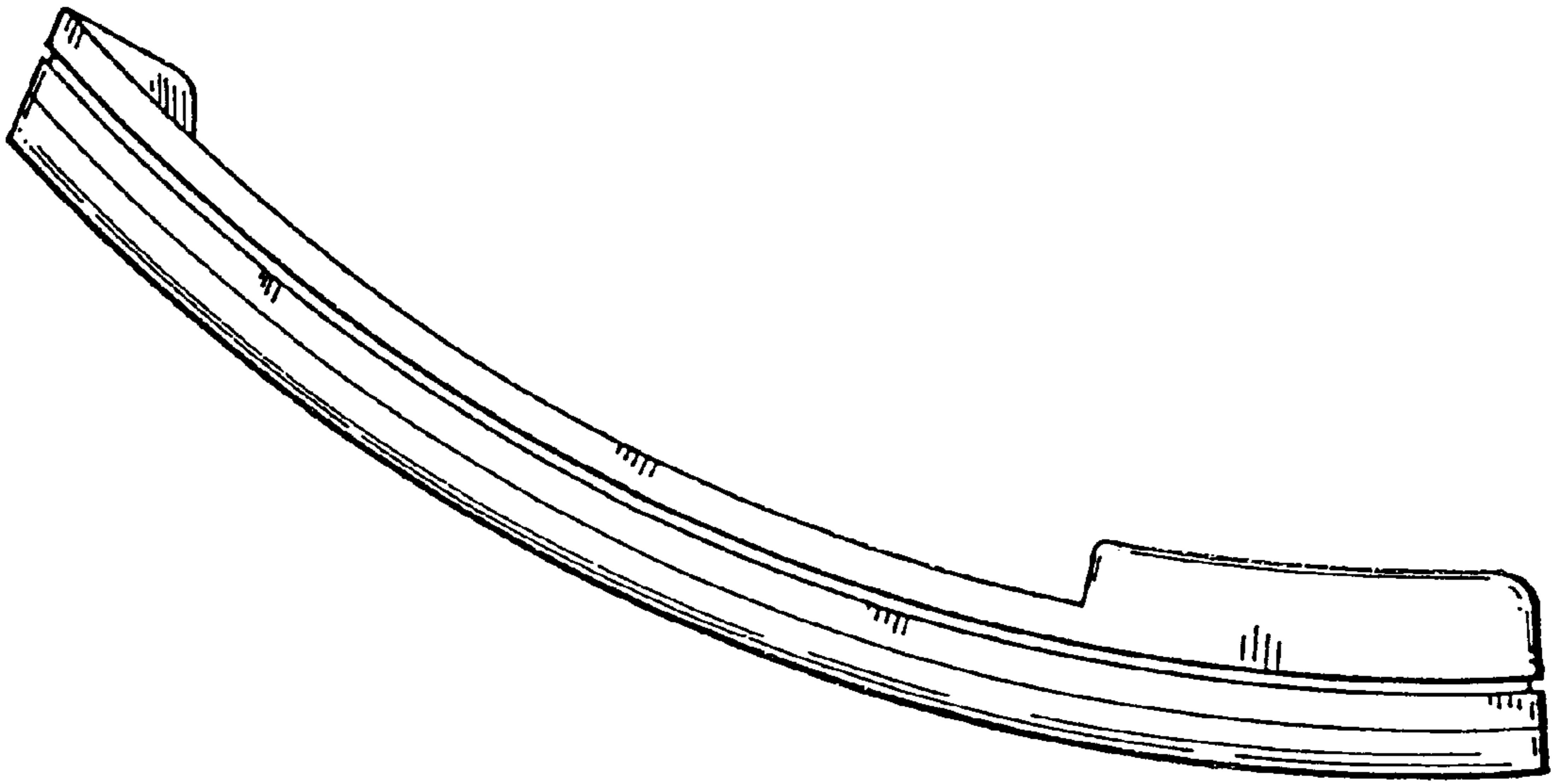

FIG. 4

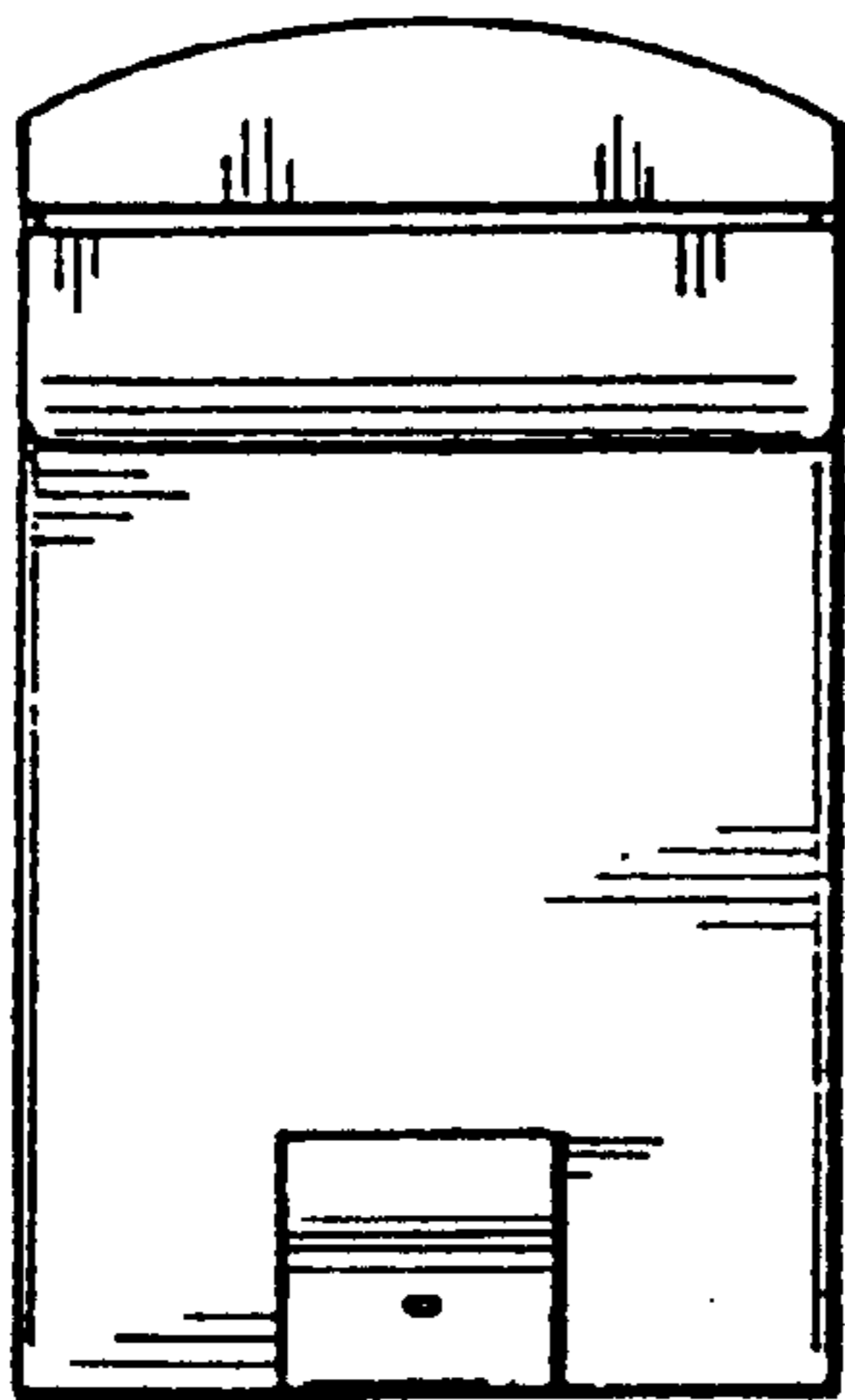

FIG. 5

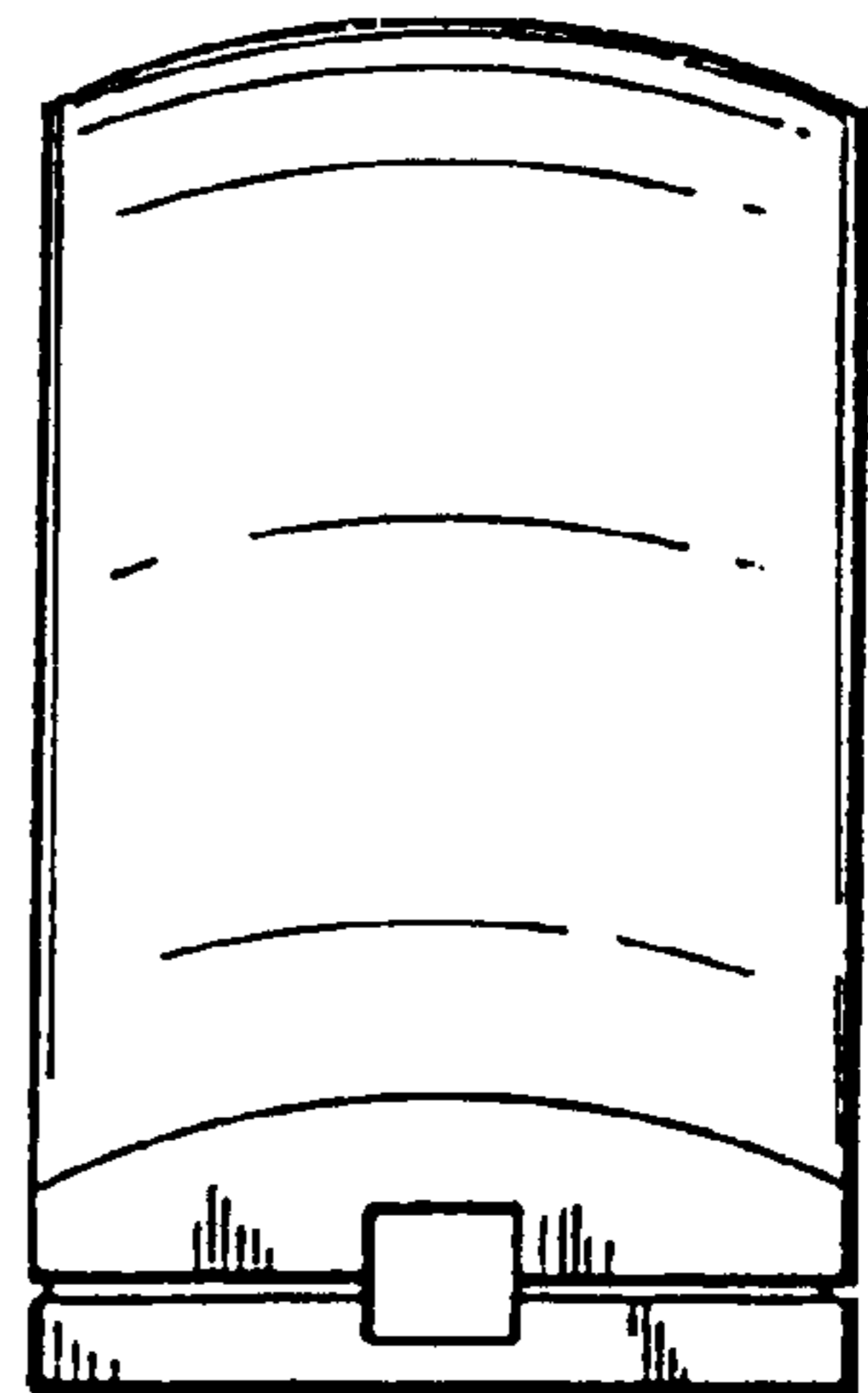

FIG. 6