



US00D430452S

# United States Patent [19]

Noda et al.

[11] Patent Number: **Des. 430,452**

[45] Date of Patent: **\*\* Sep. 5, 2000**

[54] MICROWAVE OVEN

[75] Inventors: **Kensaku Noda; Masatoshi Okuda; Yasunori Kusachi; Atsuko Kawamura**, all of Shiga-Ken, Japan

[73] Assignee: **Sanyo Electric Co., Ltd**, Osaka-Fu, Japan

[\*\*] Term: **14 Years**

[21] Appl. No.: **29/100,727**

[22] Filed: **Feb. 17, 1999**

### [30] Foreign Application Priority Data

Aug. 28, 1998 [JP] Japan ..... 10-24601

[51] LOC (7) Cl. .... **07-02**

[52] U.S. Cl. .... **D7/351**

[58] Field of Search ..... D7/350-351, 402; 126/273 R, 273 A, 275 R, 275 E, 19 M, 21 A; 219/678, 680, 756-758

### [56] References Cited

#### U.S. PATENT DOCUMENTS

- D. 299,306 1/1989 Yoshida ..... D7/351
- D. 305,492 1/1990 Kawaishi et al. .... D7/351
- D. 306,958 4/1990 Yamada et al. .... D7/351

- D. 323,953 2/1992 Kubo et al. .... D7/351
- D. 335,064 4/1993 Sugiyama et al. .... D7/351
- D. 357,159 4/1995 Mitsui et al. .... D7/351
- D. 371,039 6/1996 Matoba et al. .... D7/351
- D. 381,862 8/1997 Noda et al. .... D7/351

*Primary Examiner*—Ruth McInroy  
*Attorney, Agent, or Firm*—Darby & Darby

### [57] CLAIM

We claim the ornamental design for a microwave oven, as shown and described.

### DESCRIPTION

FIG. 1 is a top, front, and right side perspective view of our new design for a microwave oven;  
 FIG. 2 is a front elevation view of our new design;  
 FIG. 3 is a rear elevation view thereof;  
 FIG. 4 is a top plan view thereof;  
 FIG. 5 is a bottom plan view thereof;  
 FIG. 6 is a right side elevation view thereof;  
 FIG. 7 is a left side elevation view thereof;  
 FIG. 8 is a front elevation view with the door open;  
 FIG. 9 is a top, front and right side perspective view thereof with the exhaust outlet cover opened; and,  
 FIG. 10 is a top, front and right side perspective view thereof, the details shown in broken lines are for illustrative purposes only and form no part of the claimed design.

**1 Claim, 9 Drawing Sheets**

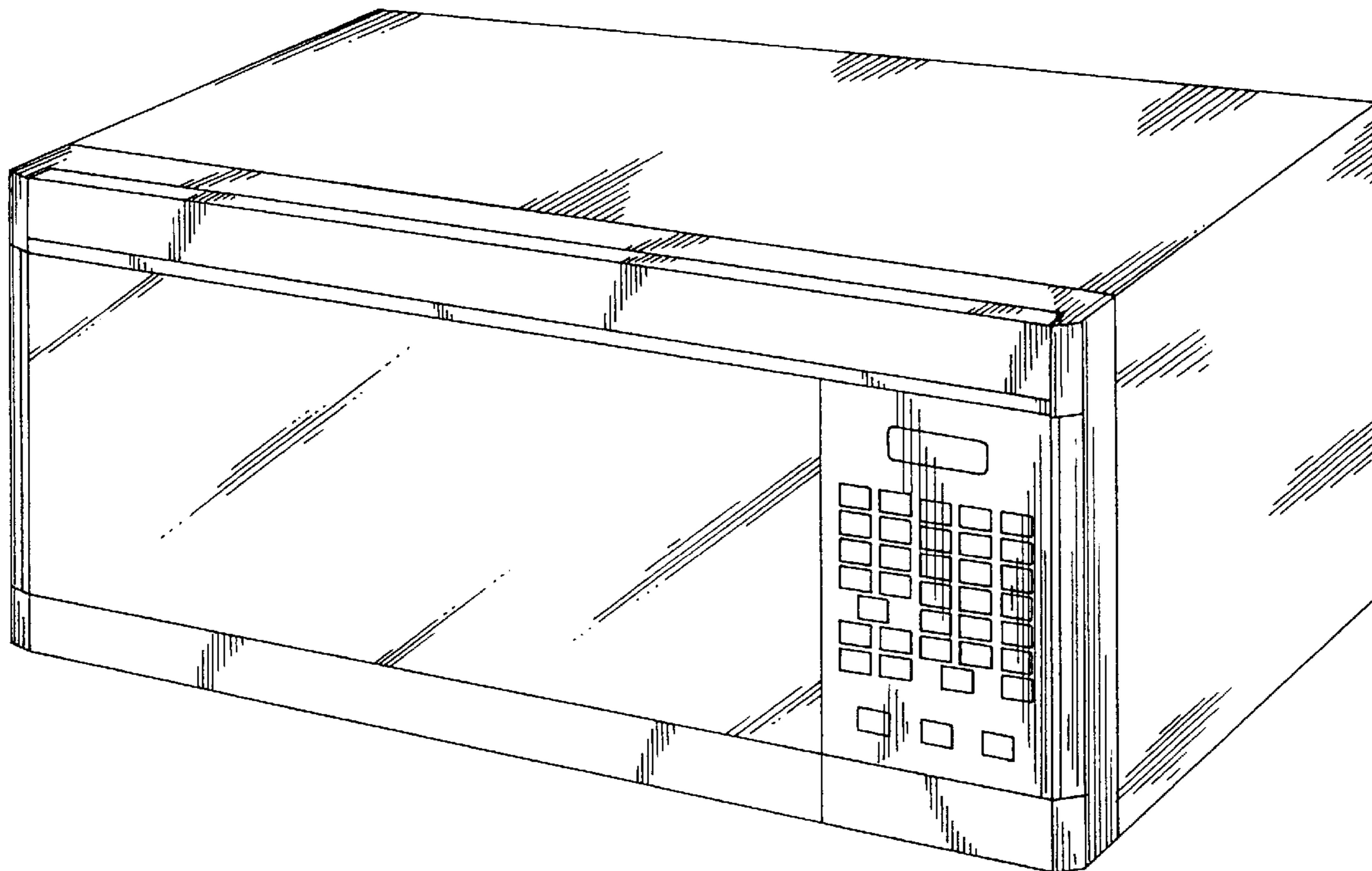

FIG. 1

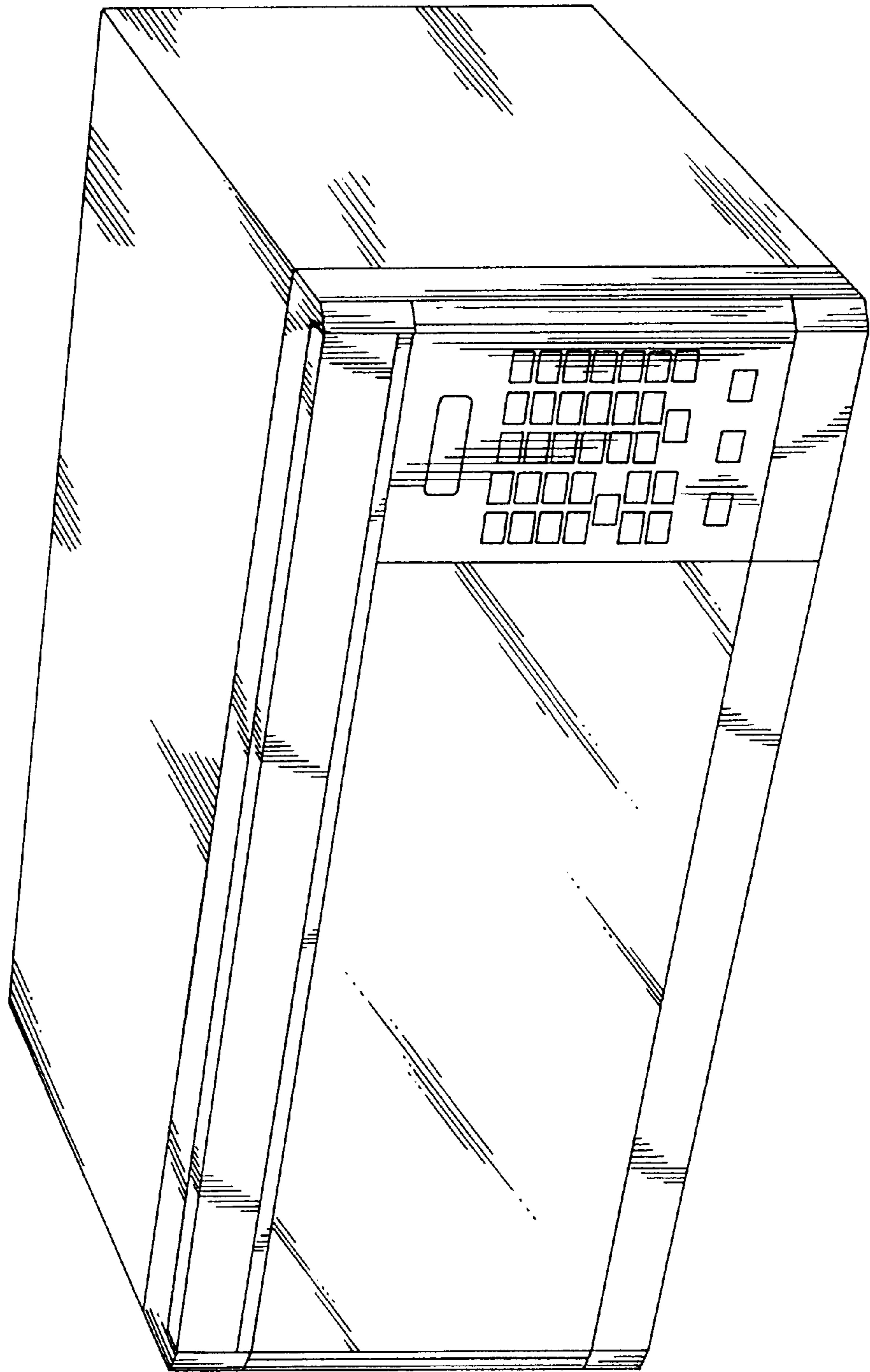

FIG. 2

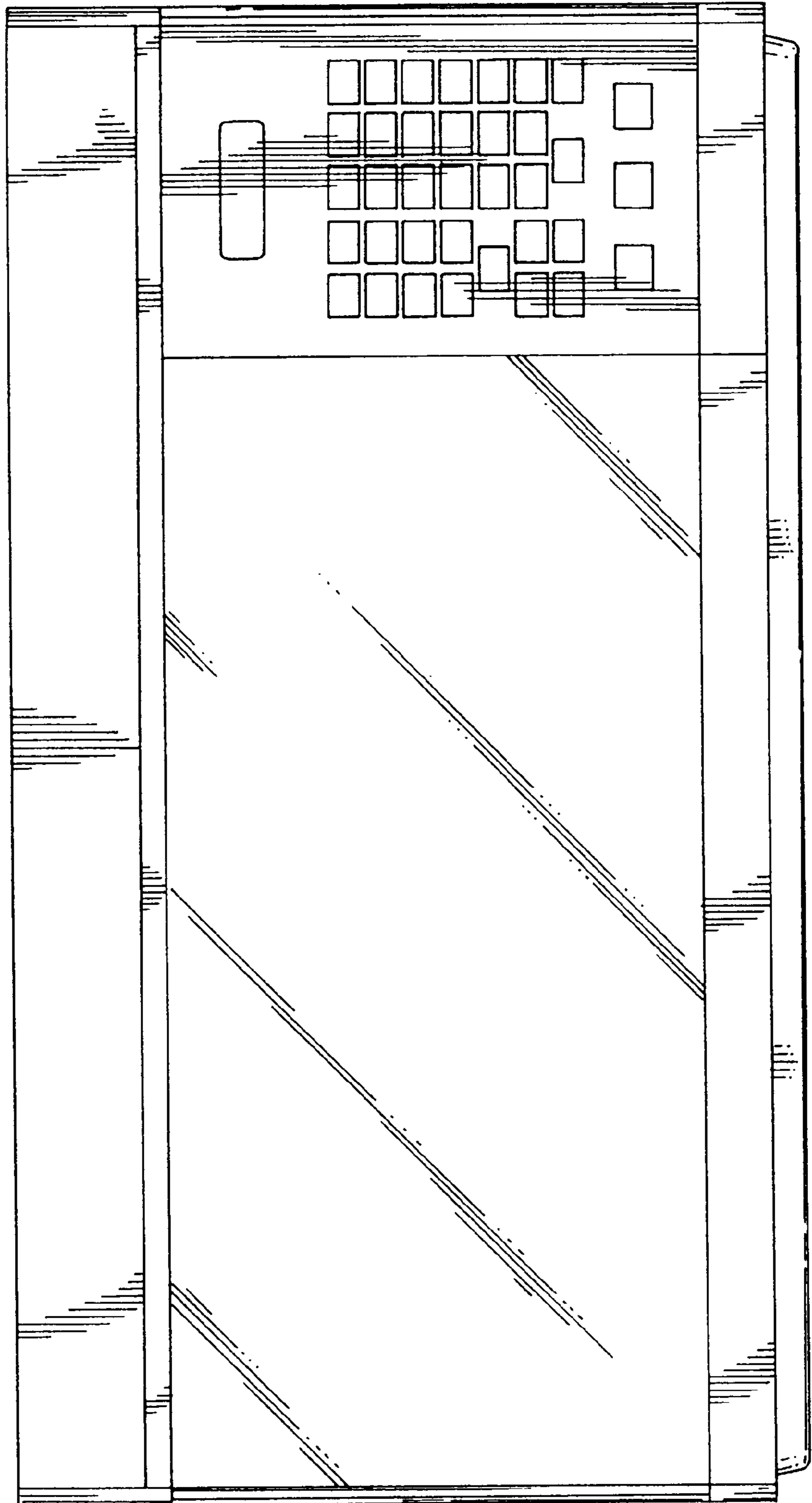

FIG. 3

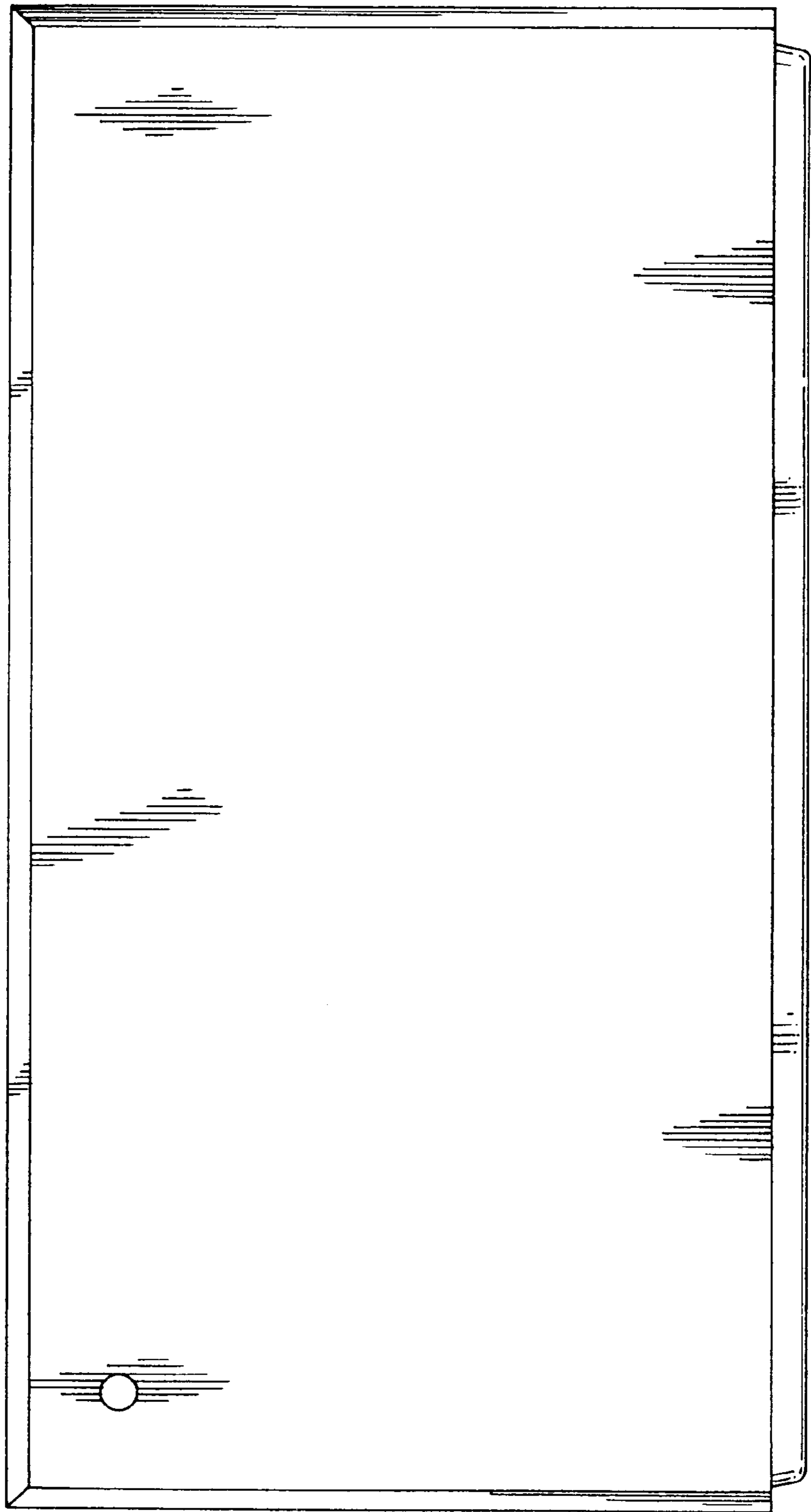

FIG. 4

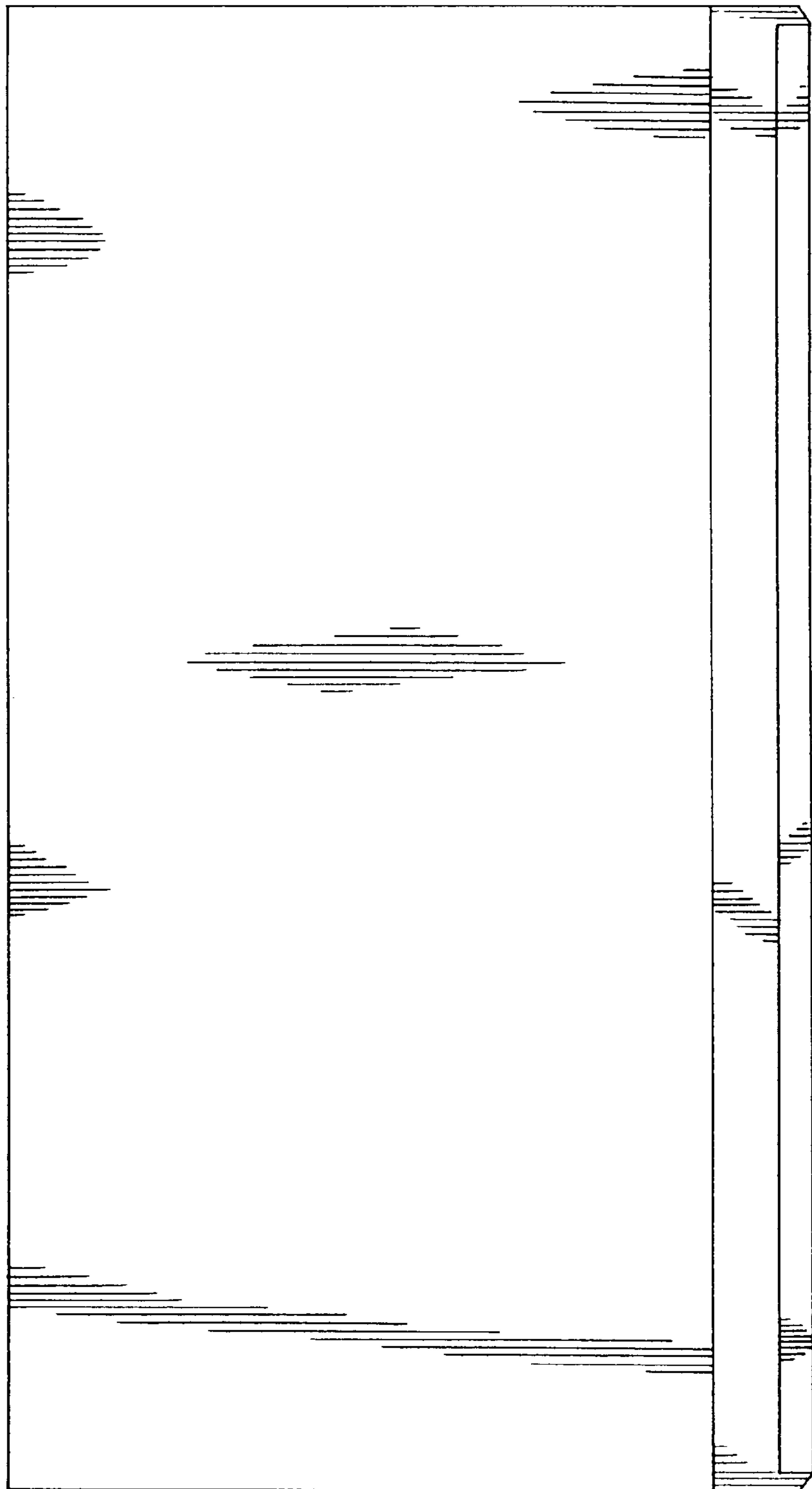

FIG. 5

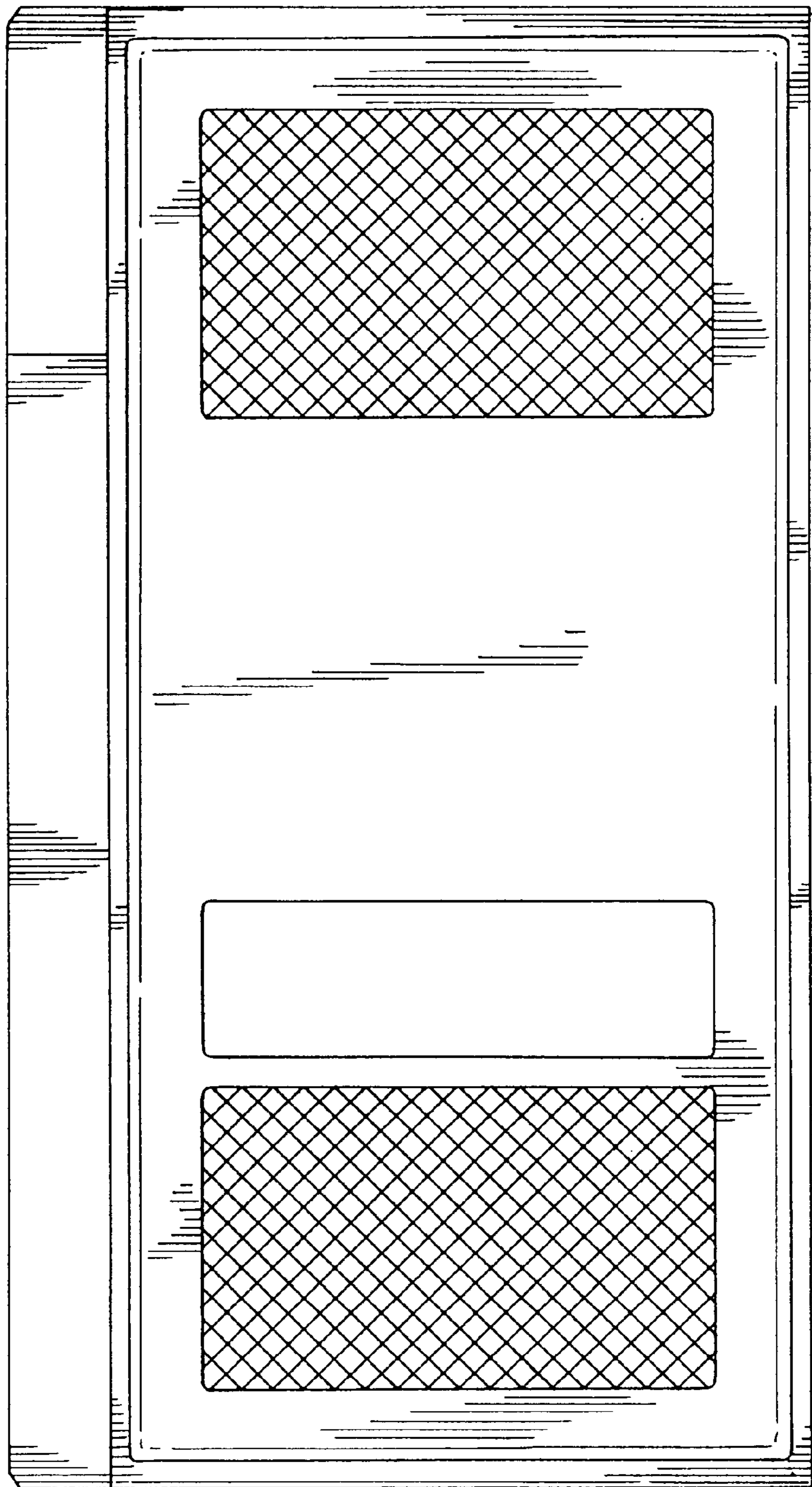

FIG. 6

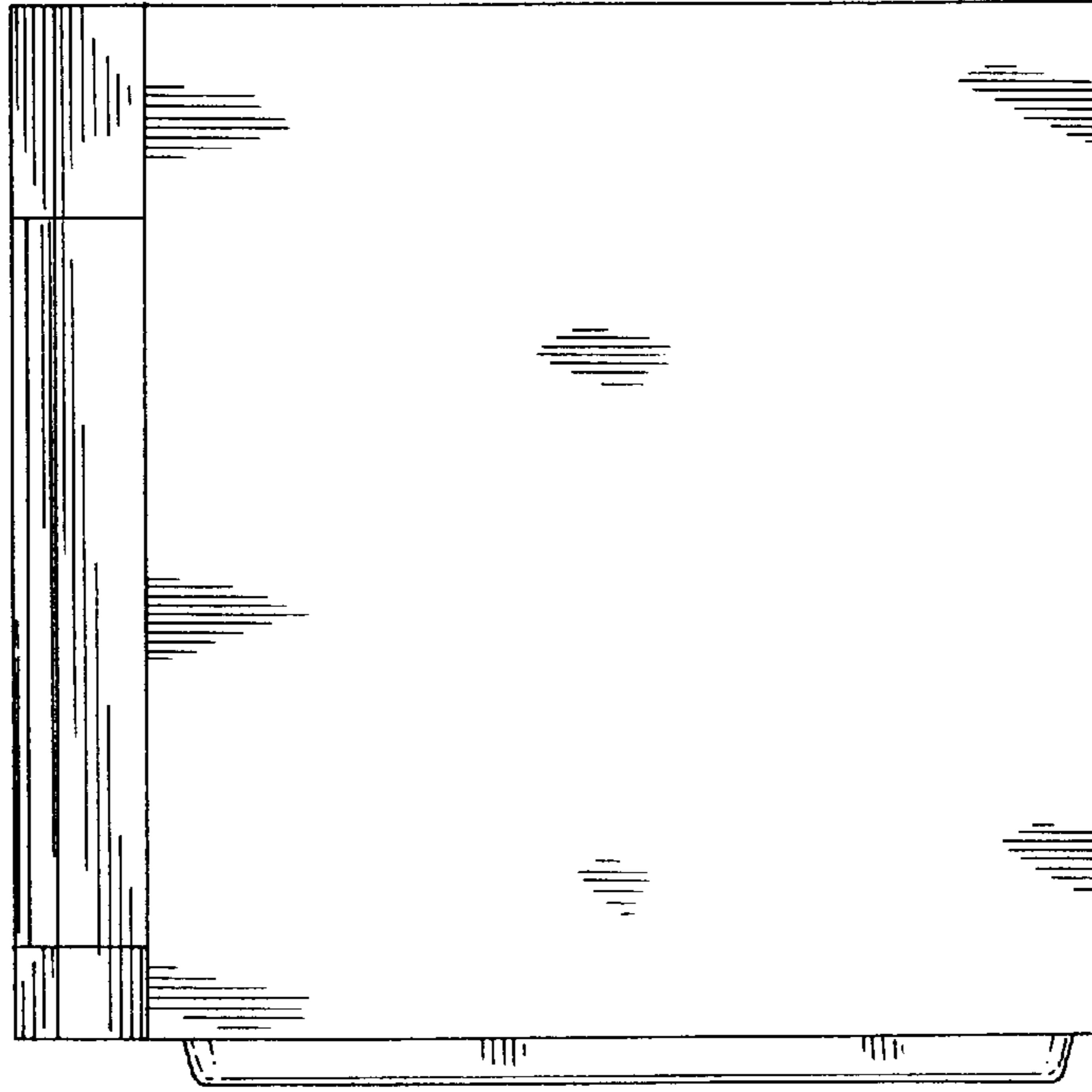

FIG. 7

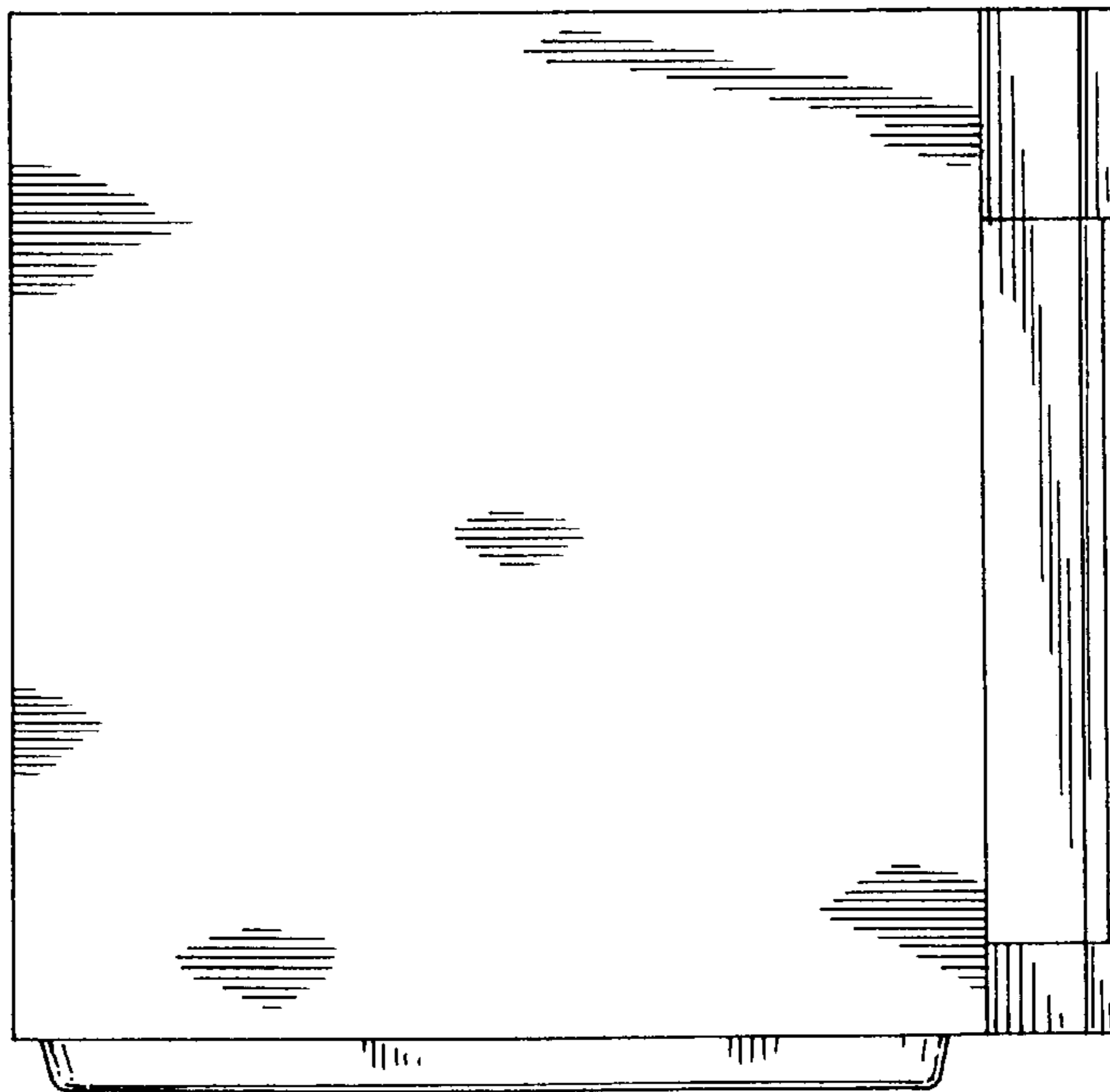

FIG. 8

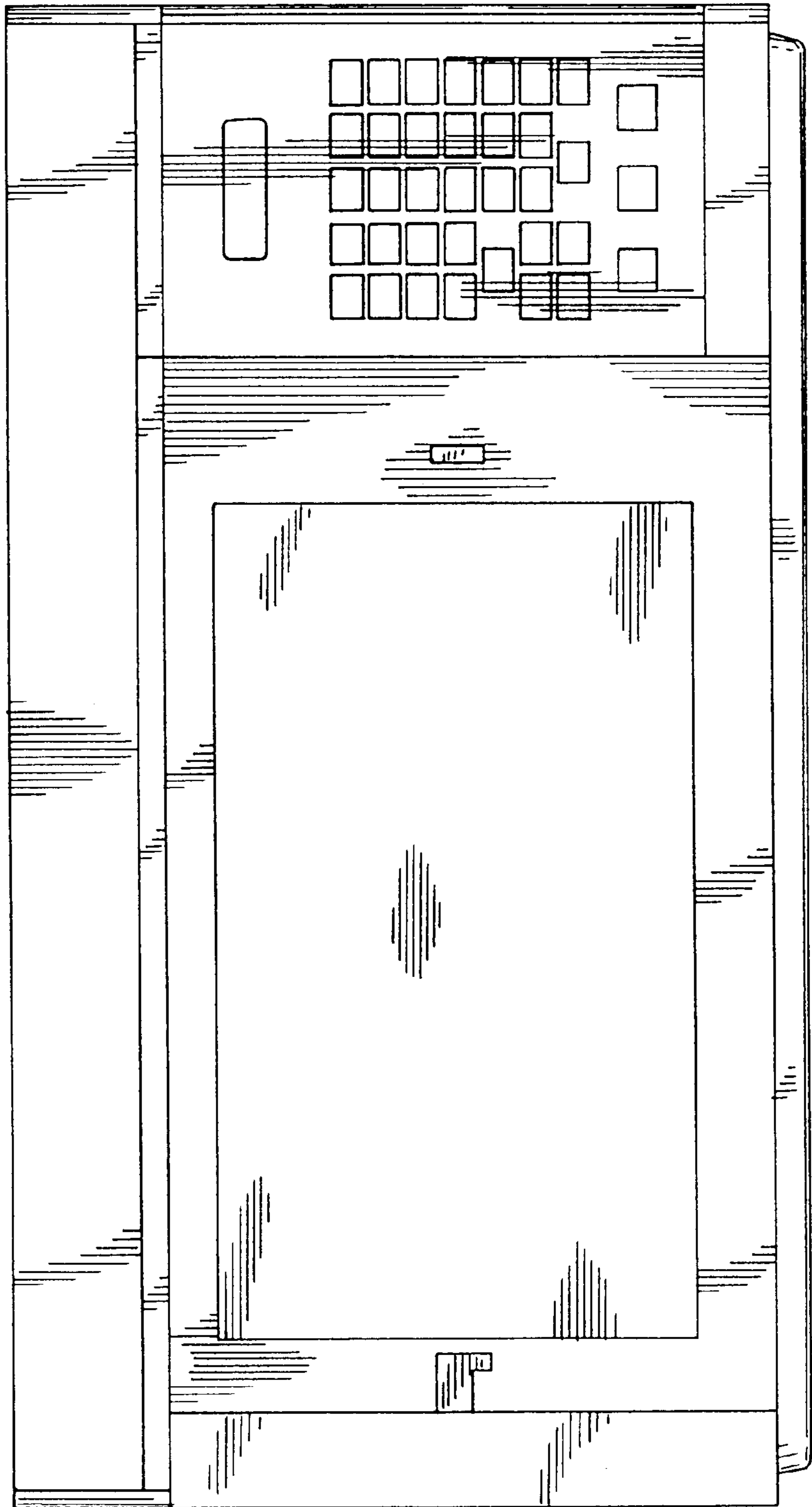



FIG. 9

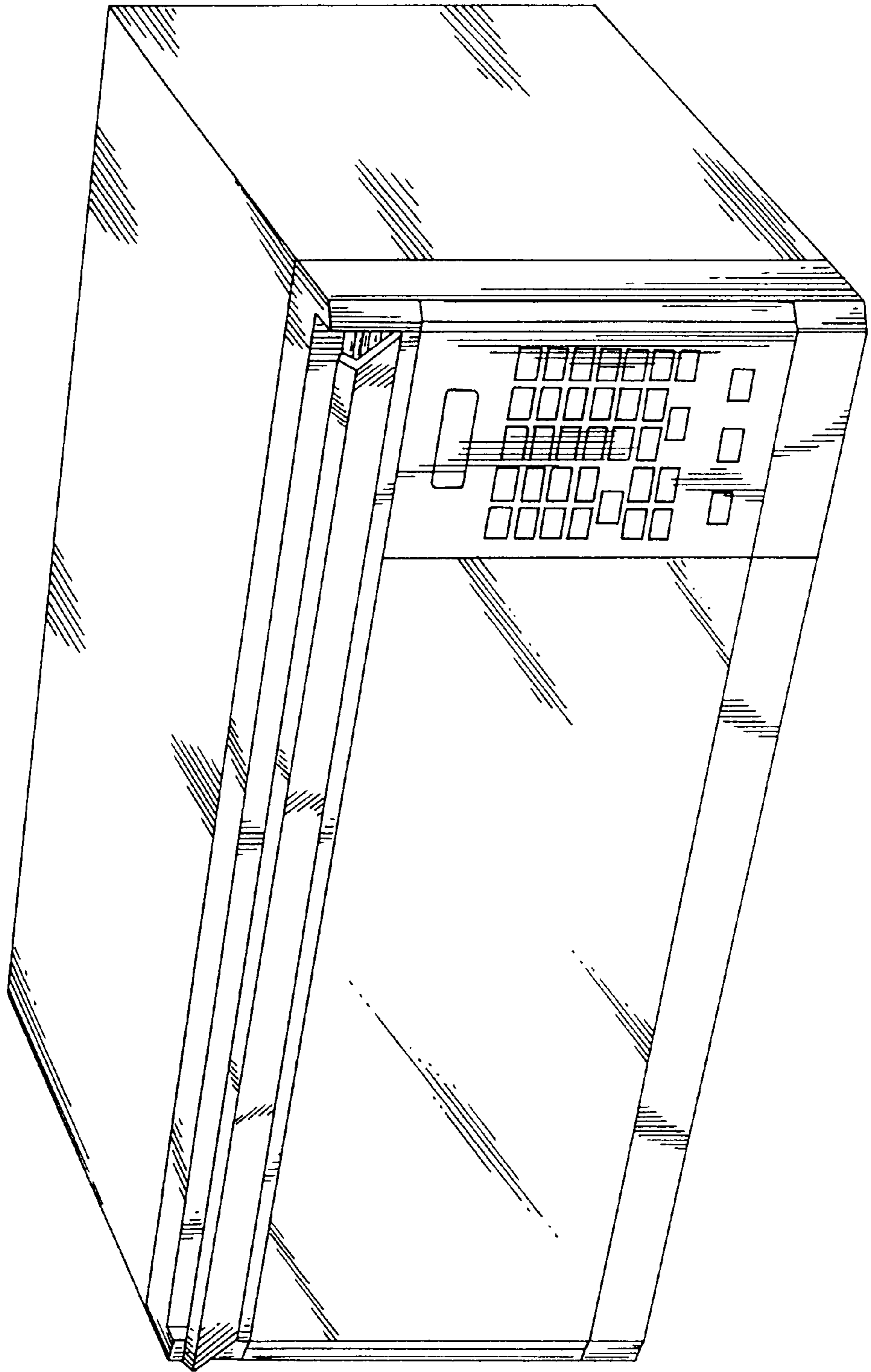

FIG. 10

