



US00D430421S

# United States Patent [19]

Natuzzi et al.

[11] Patent Number: **Des. 430,421**

[45] Date of Patent: **\*\* Sep. 5, 2000**

[54] SEAT

[75] Inventors: **Pasquale Natuzzi; Domenico Abbruzzese**, both of Bari, Italy

[73] Assignee: **Industrie Natuzzi SpA**, Bari, Italy

[\*\*] Term: **14 Years**

[21] Appl. No.: **29/110,570**

[22] Filed: **Sep. 9, 1999**

[51] **LOC (7) Cl.** ..... **06-01**

[52] **U.S. Cl.** ..... **D6/381; D6/334**

[58] **Field of Search** ..... D6/334, 335, 364, D6/371, 373, 381, 500, 501, 502; 5/12.1; 297/232

## [56] References Cited

### U.S. PATENT DOCUMENTS

D. 353,948	1/1995	Lowman	.....	D6/381
D. 367,180	2/1996	Natuzzi et al.	.....	D6/381
D. 367,187	2/1996	Natuzzi et al.	.....	D6/381
D. 369,479	5/1996	Natuzzi et al.	.....	D6/381
D. 373,484	9/1996	Natuzzi et al.	.....	D6/381
D. 373,485	9/1996	Natuzzi et al.	.....	D6/381
D. 376,925	12/1996	Paus	.....	D6/381
D. 379,036	5/1997	Natuzzi et al.	.....	D6/381
D. 388,631	1/1998	Natuzzi et al.	.....	D6/381
D. 388,970	1/1998	Natuzzi et al.	.....	D6/381
D. 399,361	10/1998	Natuzzi et al.	.....	D6/381
D. 399,363	10/1998	Natuzzi et al.	.....	D6/381
D. 403,173	12/1998	Ferguson et al.	.....	D6/381
D. 414,954	10/1999	Christa et al.	.....	D6/381
D. 418,992	1/2000	Natuzzi et al.	.....	D6/381

### OTHER PUBLICATIONS

Natuzzi Model 723, sofa, love seat & chair shown, International Home Furnishings Market, High Point, NC, Oct. 1989.

Natuzzi Model 499, Apr. 1989, at International Home Furnishings Market in High Point, North Carolina.

Natuzzi Model 616/617, Oct. 1988, at International Home Furnishings Market in High Point, North Carolina.

Natuzzi Model 622/623, Oct. 1988, at International Home Furnishings Market in High Point, North Carolina.

Natuzzi Model 753, Apr. 1990, at International Home Furnishings Market in High Point, North Carolina.  
 Natuzzi Model 782, Oct. 1990, at International Home Furnishings Market in High Point, North Carolina.  
 Natuzzi Model 949, Oct. 1992, at International Home Furnishings Market in High Point, North Carolina.  
 Natuzzi Model 1086, Oct. 1993, at International Home Furnishings Market in High Point, North Carolina.  
 Natuzzi Model 1090, Oct. 1993, at International Home Furnishings Market in High Point, North Carolina.  
 Natuzzi Model 1132, Jan. 1994, at International Home Furnishings Market in High Point, North Carolina.  
 Natuzzi Model 1136, Apr. 1994, at International Home Furnishings Market in High Point, North Carolina.  
 Natuzzi Model 1147, Apr. 1994, at International Home Furnishings Market in High Point, North Carolina.

(List continued on next page.)

*Primary Examiner*—Gary D. Watson  
*Attorney, Agent, or Firm*—Alston & Bird LLP

## [57] CLAIM

The ornamental design for a seat, as shown and described.

## DESCRIPTION

FIG. 1 is a front perspective view of a seat showing our new design in the form of a sofa;  
 FIG. 2 is a front elevational view thereof;  
 FIG. 3 is a top plan view thereof;  
 FIG. 4 is a right side elevational view, the left side being a mirror image thereof;  
 FIG. 5 is a rear perspective view thereof;  
 FIG. 6 is a front elevational view of a seat showing our new design in the form of a loveseat; and,  
 FIG. 7 is a front elevational view of a seat showing our new design in the form of a chair.

The broken lines shown herein are for illustrative purposes only and form no part of the claimed design.

The rear views of FIGS. 6 and 7 are like FIG. 5, the difference being a matter of length.

The end views of FIGS. 6 and 7 are like FIG. 4.

FIGS. 1 and 5 are shown on an enlarged scale with respect to the other views.

**1 Claim, 3 Drawing Sheets**

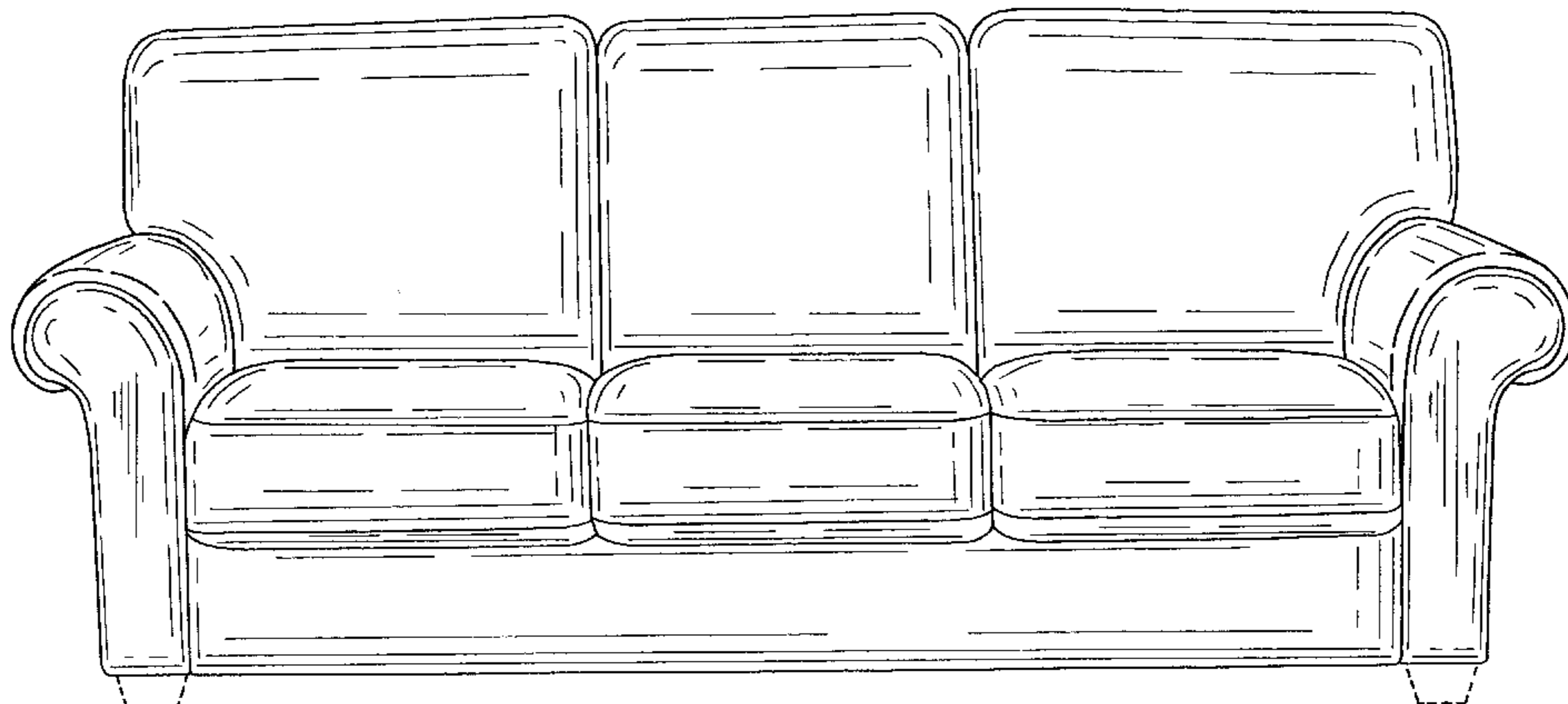

OTHER PUBLICATIONS

Natuzzi Model 1157, Apr. 1994, at International Home Furnishings Market in High Point, North Carolina.  
Natuzzi Model 1162, Apr. 1994, at International Home Furnishings Market in High Point, North Carolina.  
Natuzzi Model 1183, Apr. 1994, at International Home Furnishings Market in High Point, North Carolina.  
Natuzzi Model 1190, Apr. 1994, at International Home Furnishings Market in High Point, North Carolina.  
Natuzzi Model 1204, Oct. 1994, at International Home Furnishings Market in High Point, North Carolina.  
Natuzzi Model 1276, Mar. 1995, at International Home Furnishings Market in High Point, North Carolina.  
Natuzzi Model 1288, Mar. 1995, at International Home Furnishings Market in High Point, North Carolina.  
Natuzzi Model 1299, Apr. 1995, at International Home Furnishings Market in High Point, North Carolina.  
Natuzzi Model 1321, Apr. 1995, at International Home Furnishings Market in High Point, North Carolina.  
Natuzzi Model 1349, Sep. 1995, at International Home Furnishings Market in High Point, North Carolina.

Natuzzi Model 1436, Mar. 1996, at International Home Furnishings Market in High Point, North Carolina.  
Natuzzi Model 1450, Mar. 1996, at International Home Furnishings Market in High Point, North Carolina.  
Natuzzi Model 1474, Oct. 1996, at International Home Furnishings Market in High Point, North Carolina.  
Natuzzi Model 1496, Oct. 1996, at International Home Furnishings Market in High Point, North Carolina.  
Natuzzi Model 1504, Oct. 1996, at International Home Furnishings Market in High Point, North Carolina.  
Natuzzi Model 1521, Oct. 1996, at International Home Furnishings Market in High Point, North Carolina.  
Natuzzi Model 1596, Apr. 1997, at International Home Furnishings Market in High Point, North Carolina.  
Natuzzi Model 1656, Oct. 1997, at International Home Furnishings Market in High Point, North Carolina.  
Natuzzi Model 1658, Oct. 1997, at International Home Furnishings Market in High Point, North Carolina.

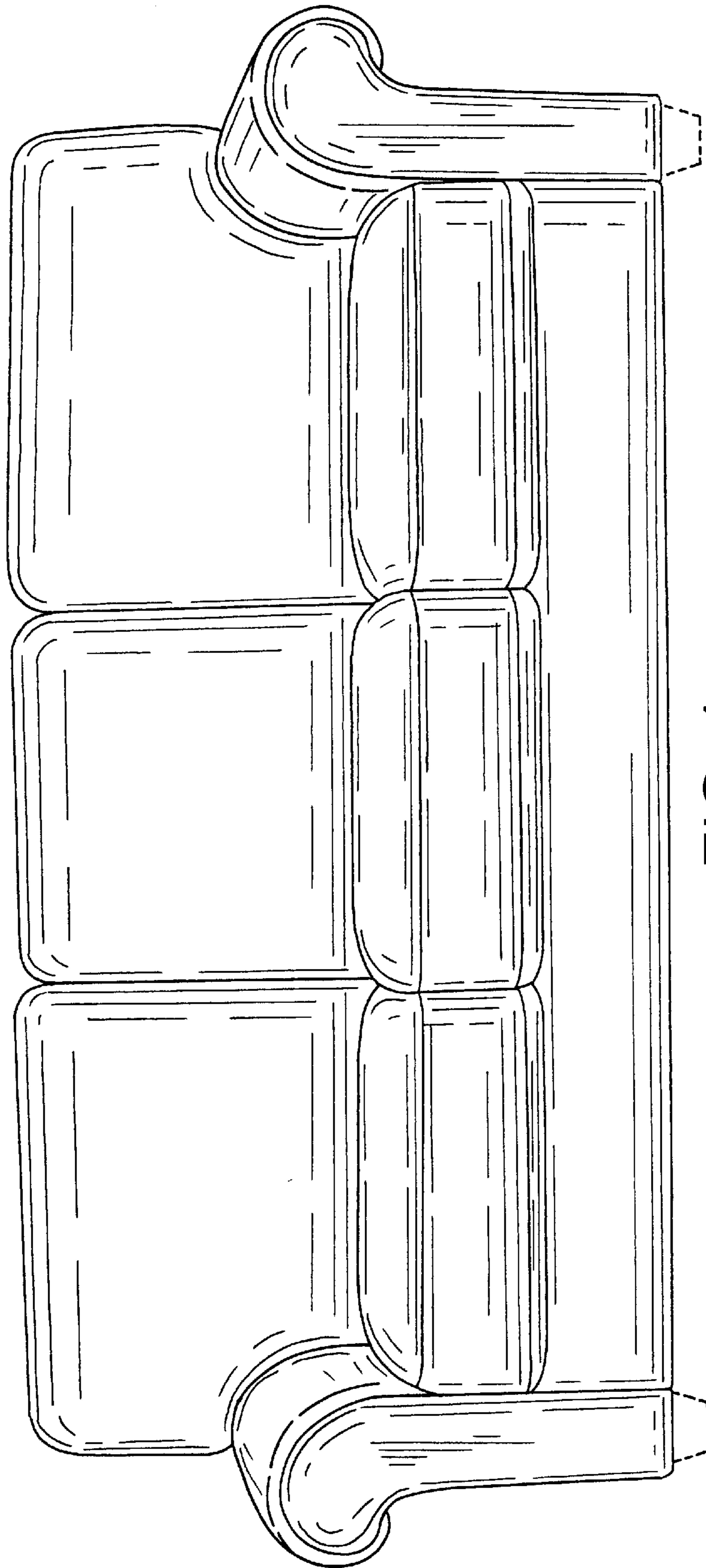

FIG. 1.



FIG. 2.

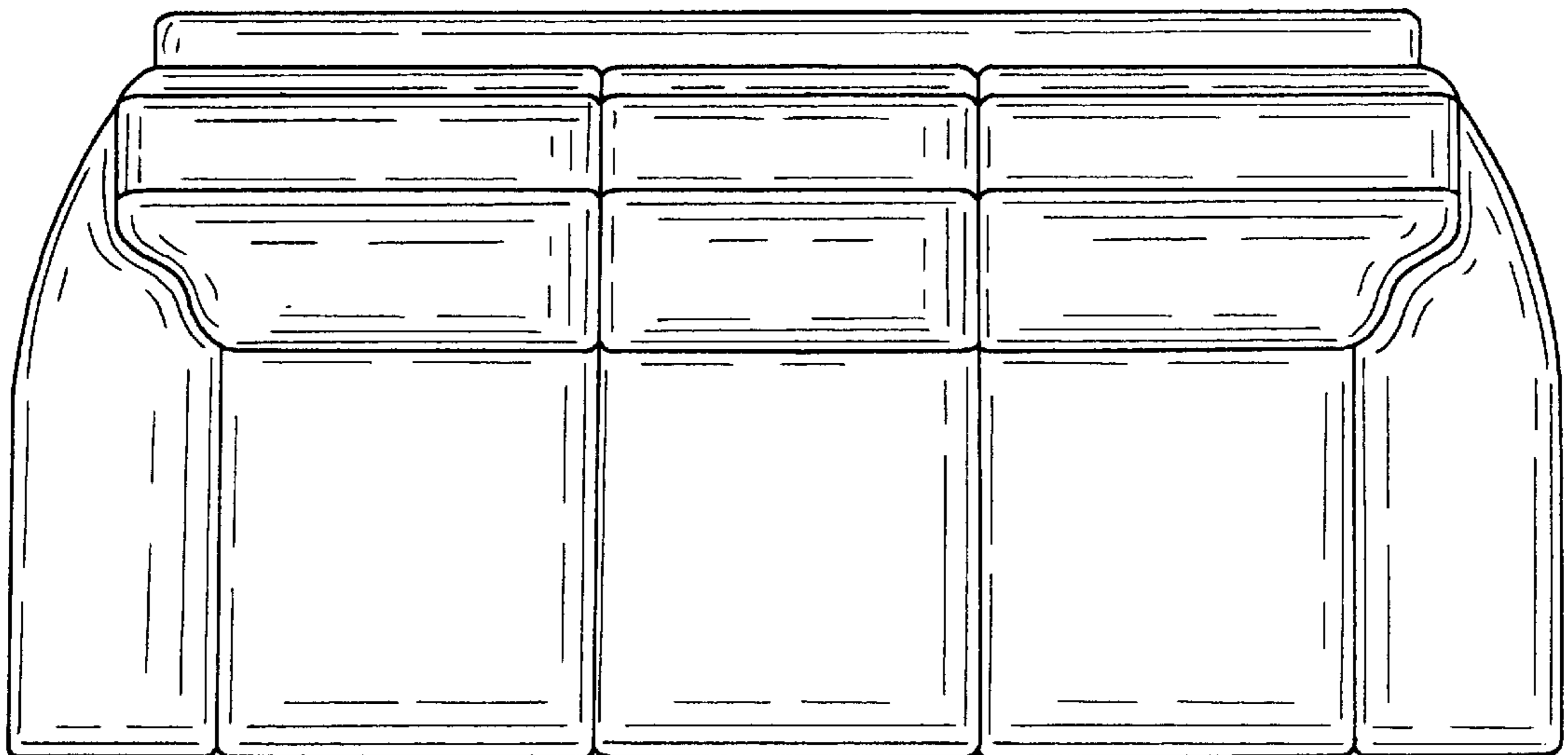

FIG. 3.

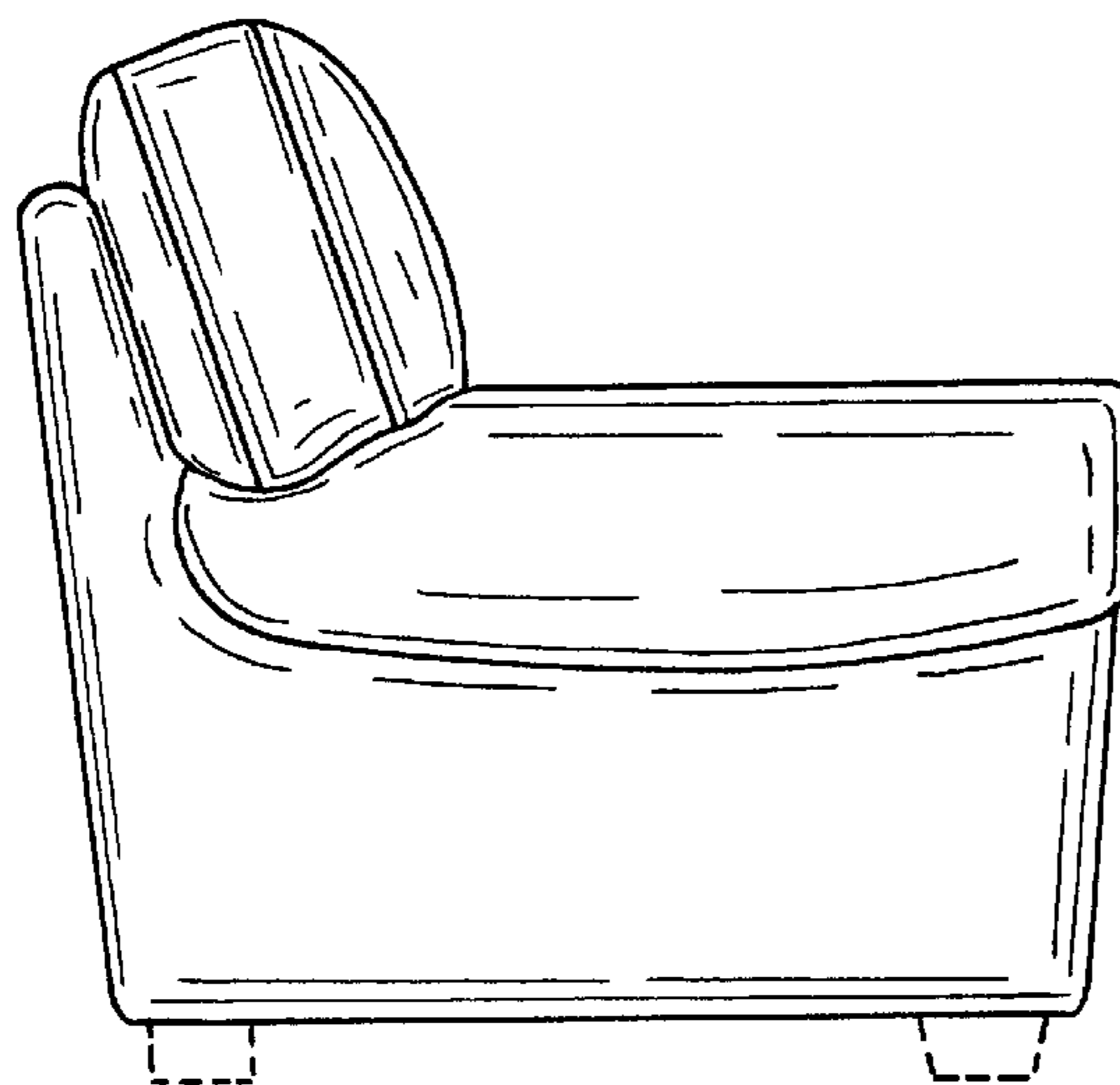

FIG. 4.

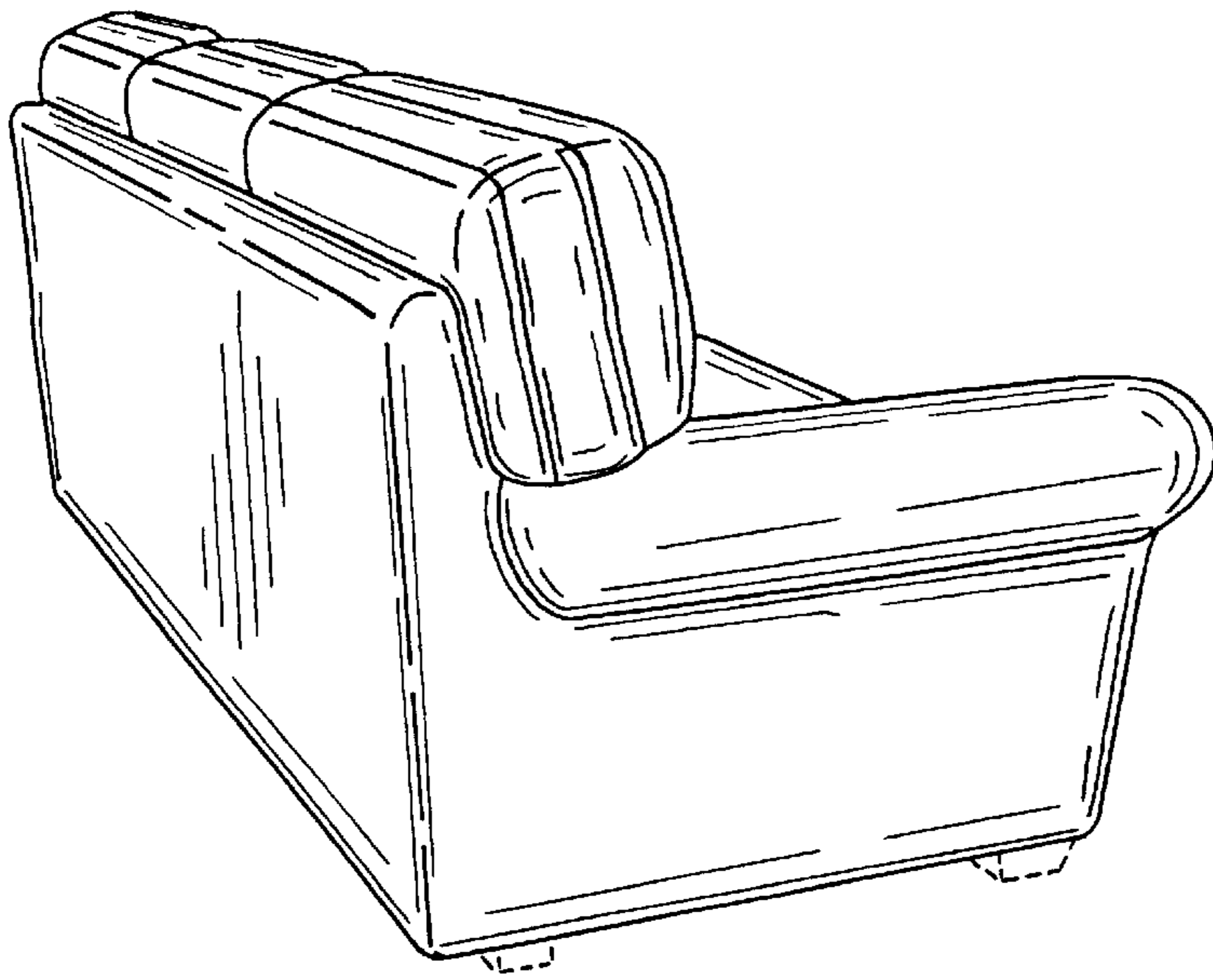

FIG. 5.

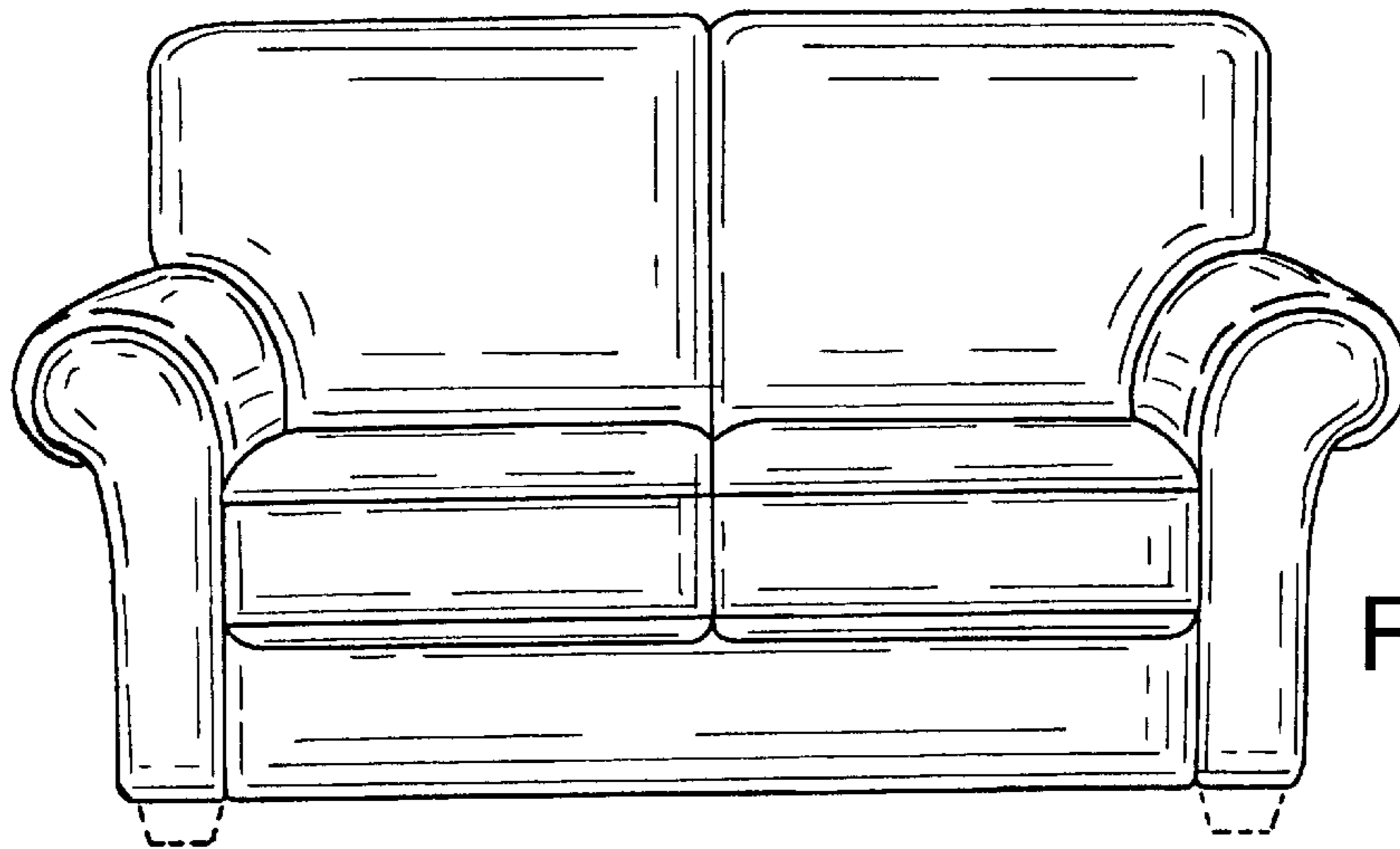

FIG. 6.

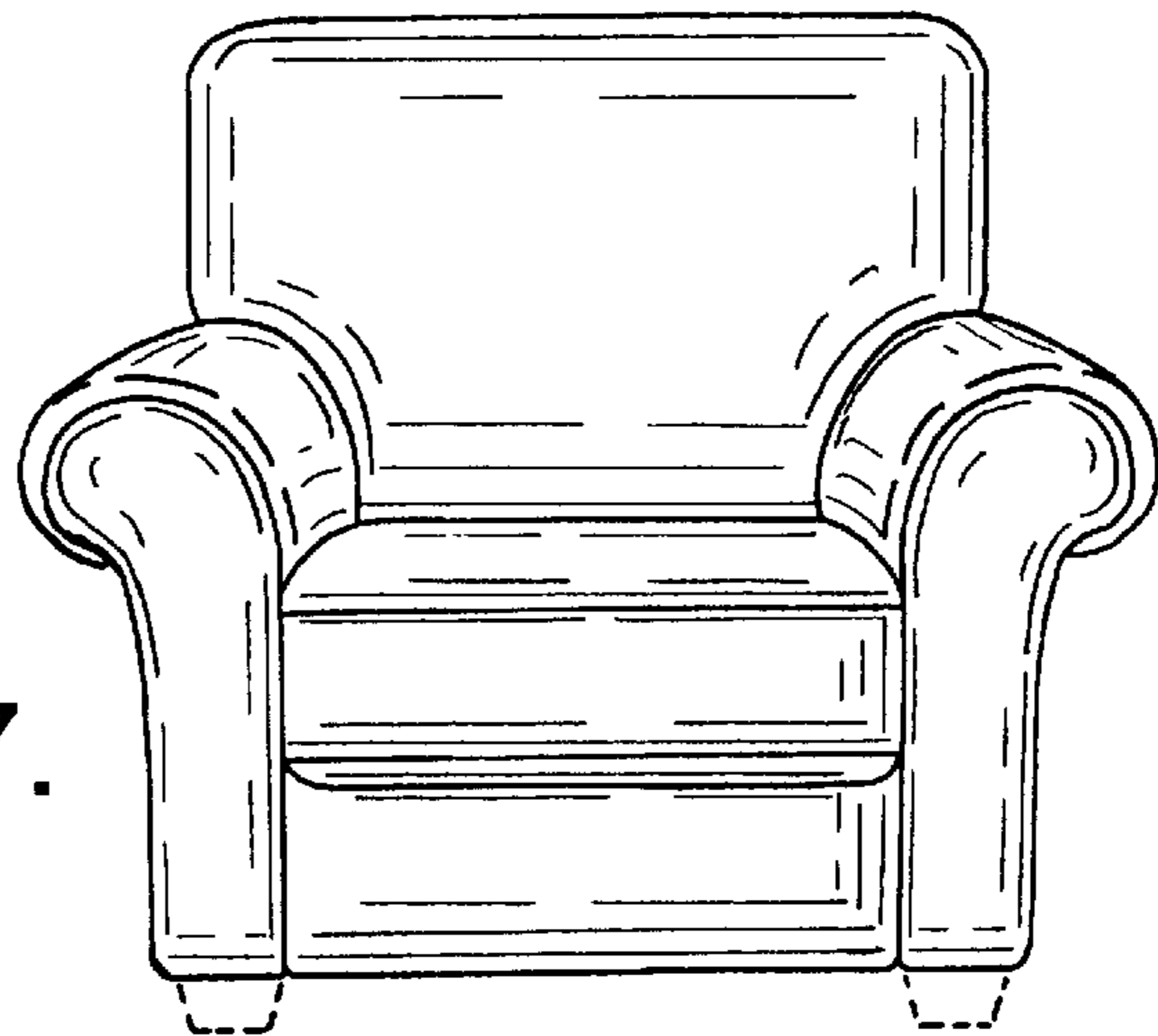

FIG. 7.