



US00D430420S

United States Patent [19] Peterson

[11] **Patent Number: Des. 430,420**

[45] **Date of Patent: ** *Sep. 5, 2000**

[54] **AIR-CUSHIONED COUCH**

[75] Inventor: **Leroy L. Peterson**, Omaha, Nebr.

[73] Assignee: **Sportsstuff Inc.**, Omaha, Nebr.

[*] Notice: This patent is subject to a terminal disclaimer.

[**] Term: **14 Years**

[21] Appl. No.: **29/104,514**

[22] Filed: **May 6, 1999**

[51] **LOC (7) Cl.** **06-01**

[52] **U.S. Cl.** **D6/381; D6/334; D6/364; D30/118**

[58] **Field of Search** **D6/331, 333, 334, D6/335, 336, 364, 365, 381-384, 500-502, 601, 604; D21/521, 803, 808; D30/108, 118; 119/28.5; 297/452.41**

[56] **References Cited**

U.S. PATENT DOCUMENTS

- D. 212,009 8/1968 Madlem D30/118
- D. 216,400 12/1969 Schwertley D30/118

- D. 309,199 7/1990 McMahon D30/118
- D. 335,044 4/1993 Sutton D6/382
- D. 382,945 8/1997 Hansen et al. D30/118
- D. 386,832 11/1997 McAlister D30/118
- D. 398,721 9/1998 Krizek D30/118
- 2,032,248 2/1936 Bing 119/28.5
- 3,902,456 9/1975 David 119/28.5
- 5,588,393 12/1996 Heilborn 119/28.5

Primary Examiner—Doris V. Coles
Assistant Examiner—Mimosa De
Attorney, Agent, or Firm—Henderson & Sturm LLP

[57] **CLAIM**

The ornamental design for an air-cushioned couch, as shown and described.

DESCRIPTION

FIG. 1 is a perspective view of the air-cushioned couch showing my new design;
FIG. 2 is a front elevational view thereof;
FIG. 3 is a rear elevational view thereof;
FIG. 4 is a top plan view thereof;
FIG. 5 is a bottom plan view thereof;
FIG. 6 is a left side elevational view thereof; and,
FIG. 7 is a right side elevational view thereof.

1 Claim, 3 Drawing Sheets

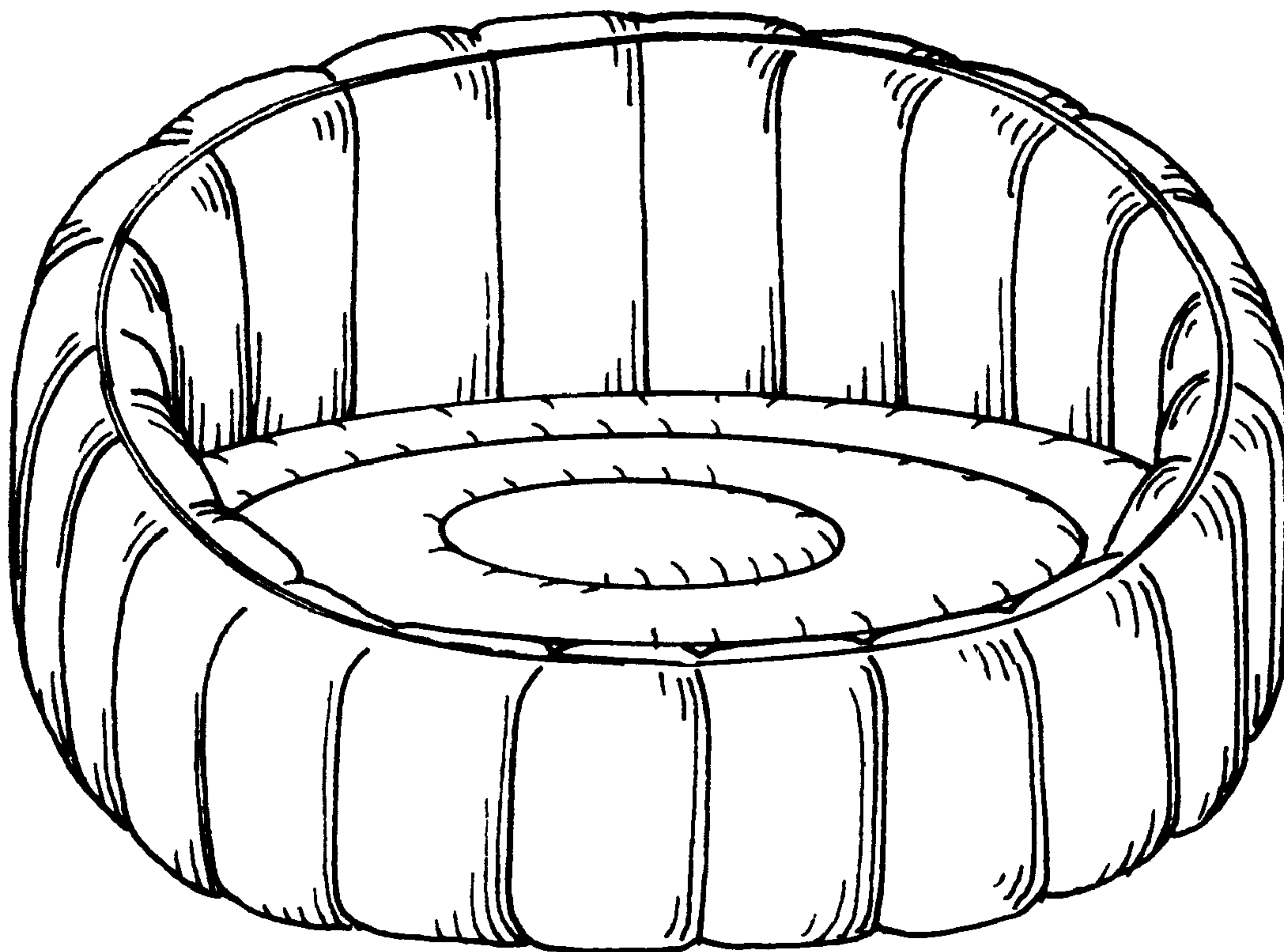

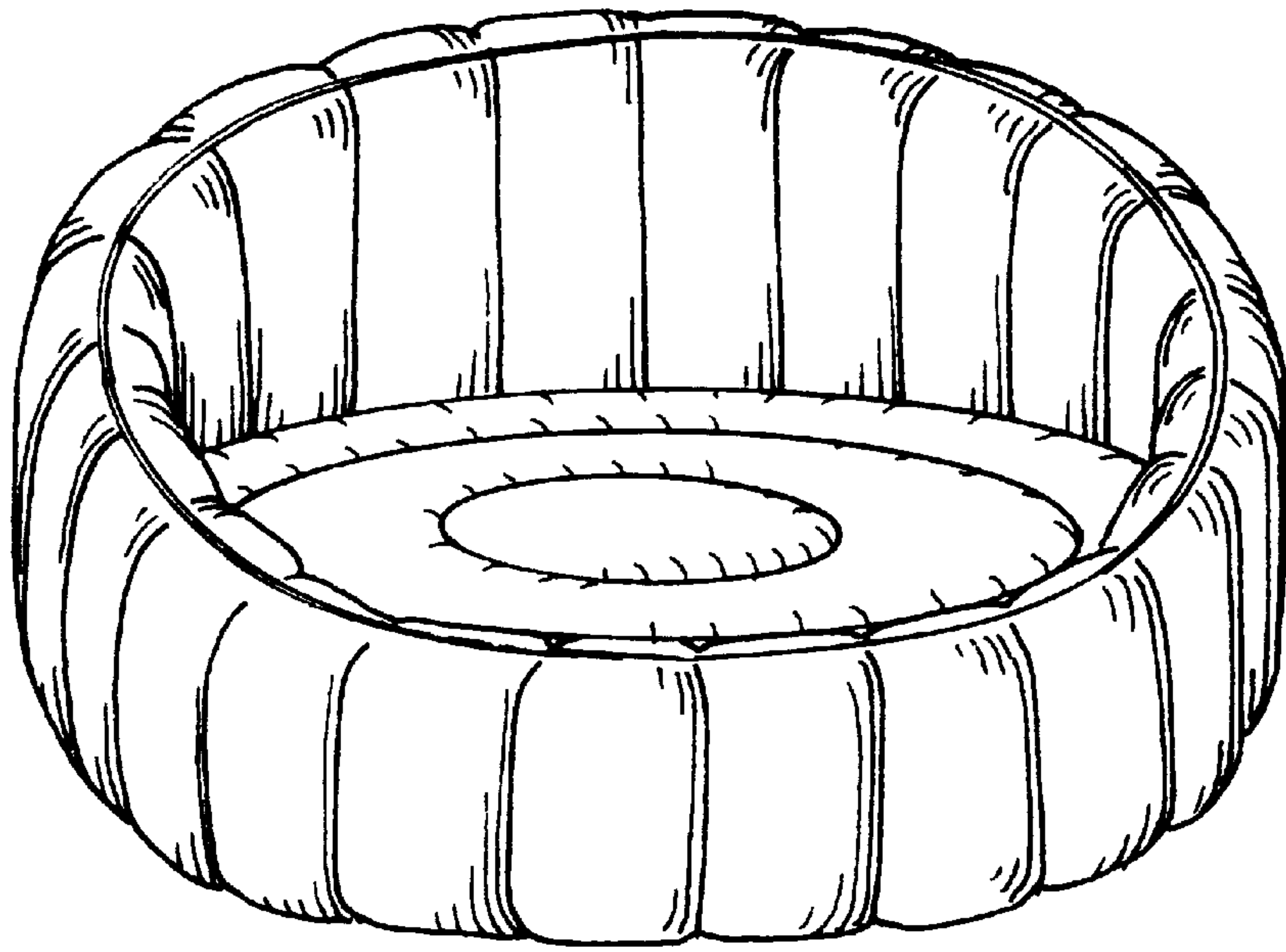

Fig. 1

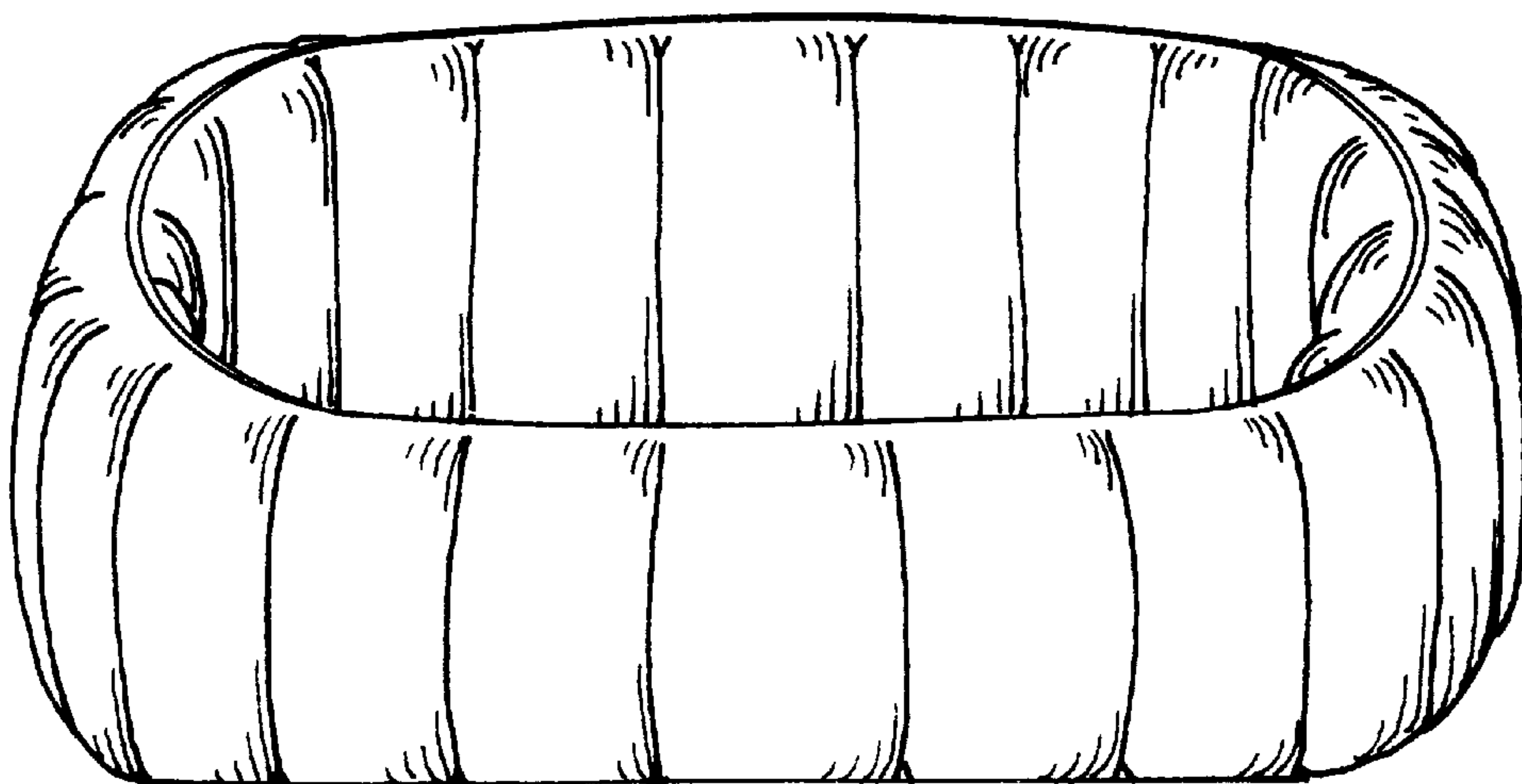

Fig. 2

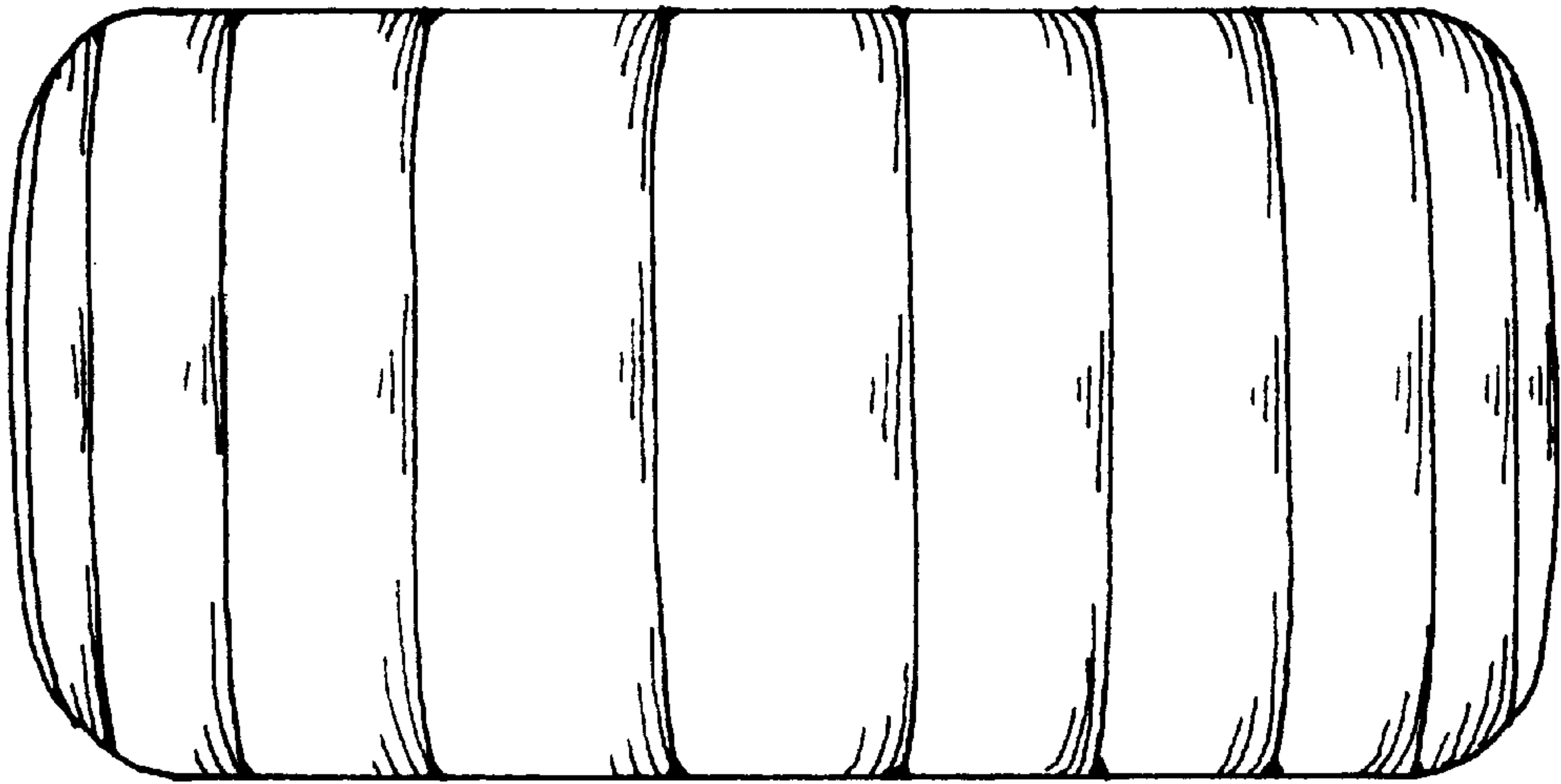

Fig. 3

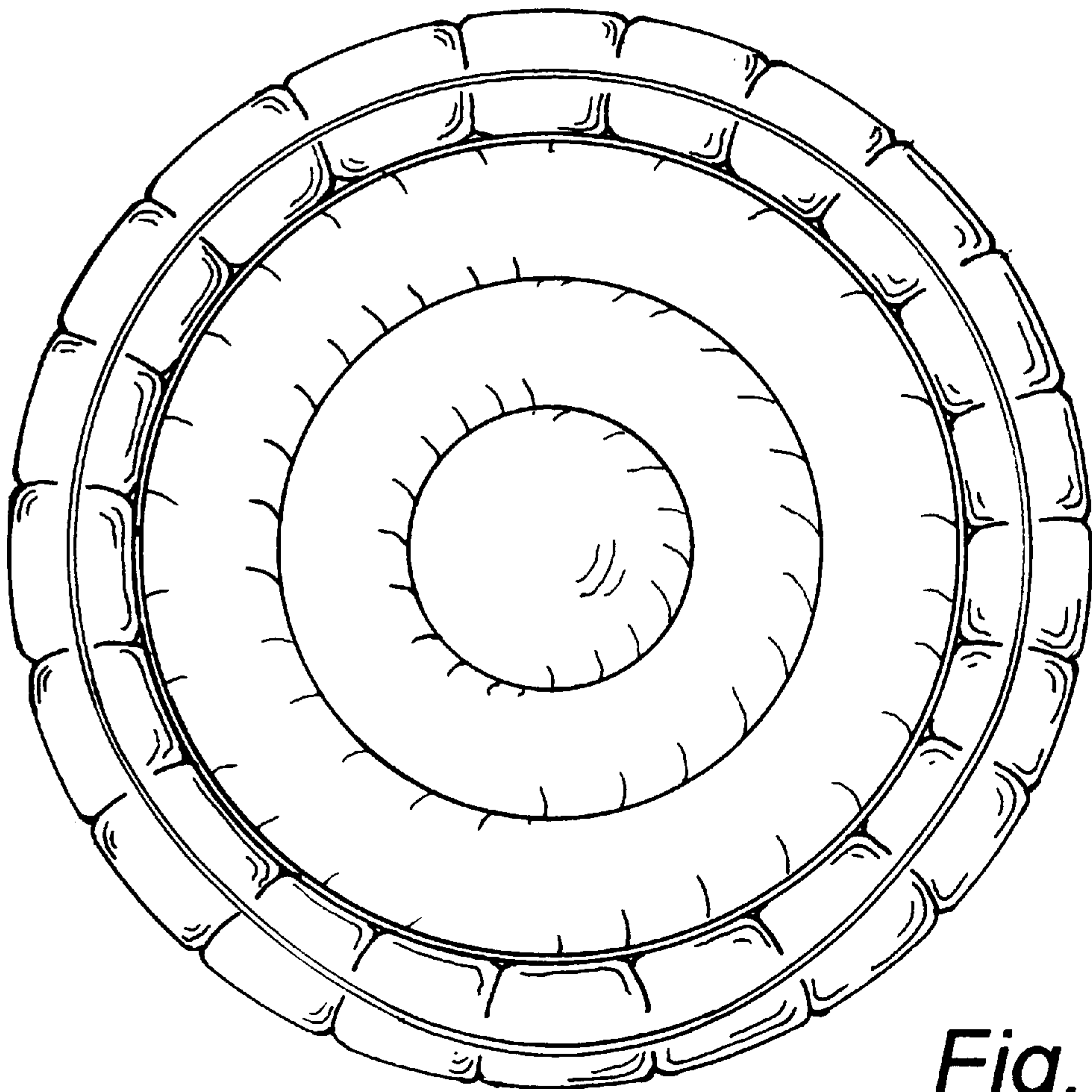

Fig. 4

Fig. 5

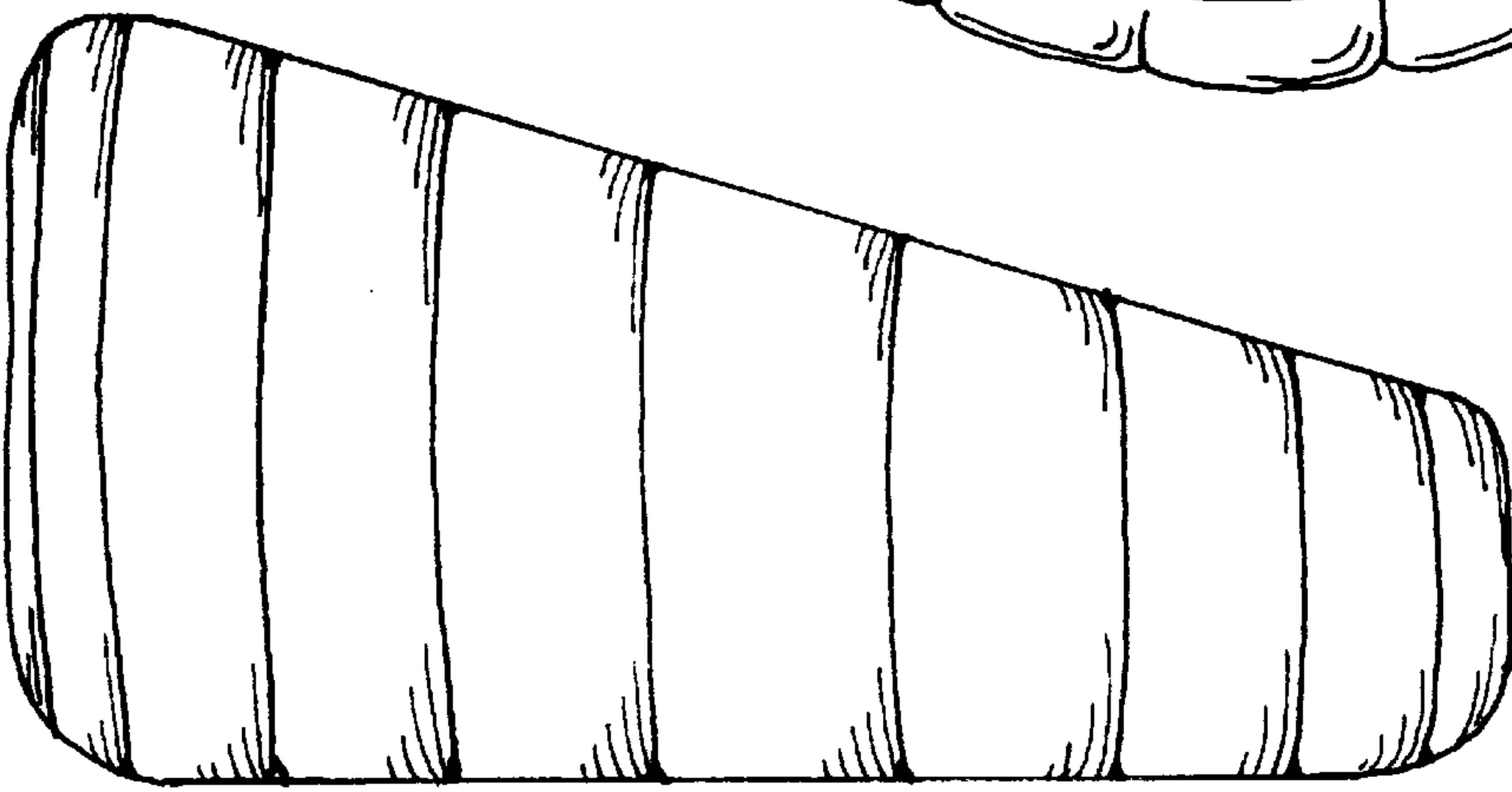
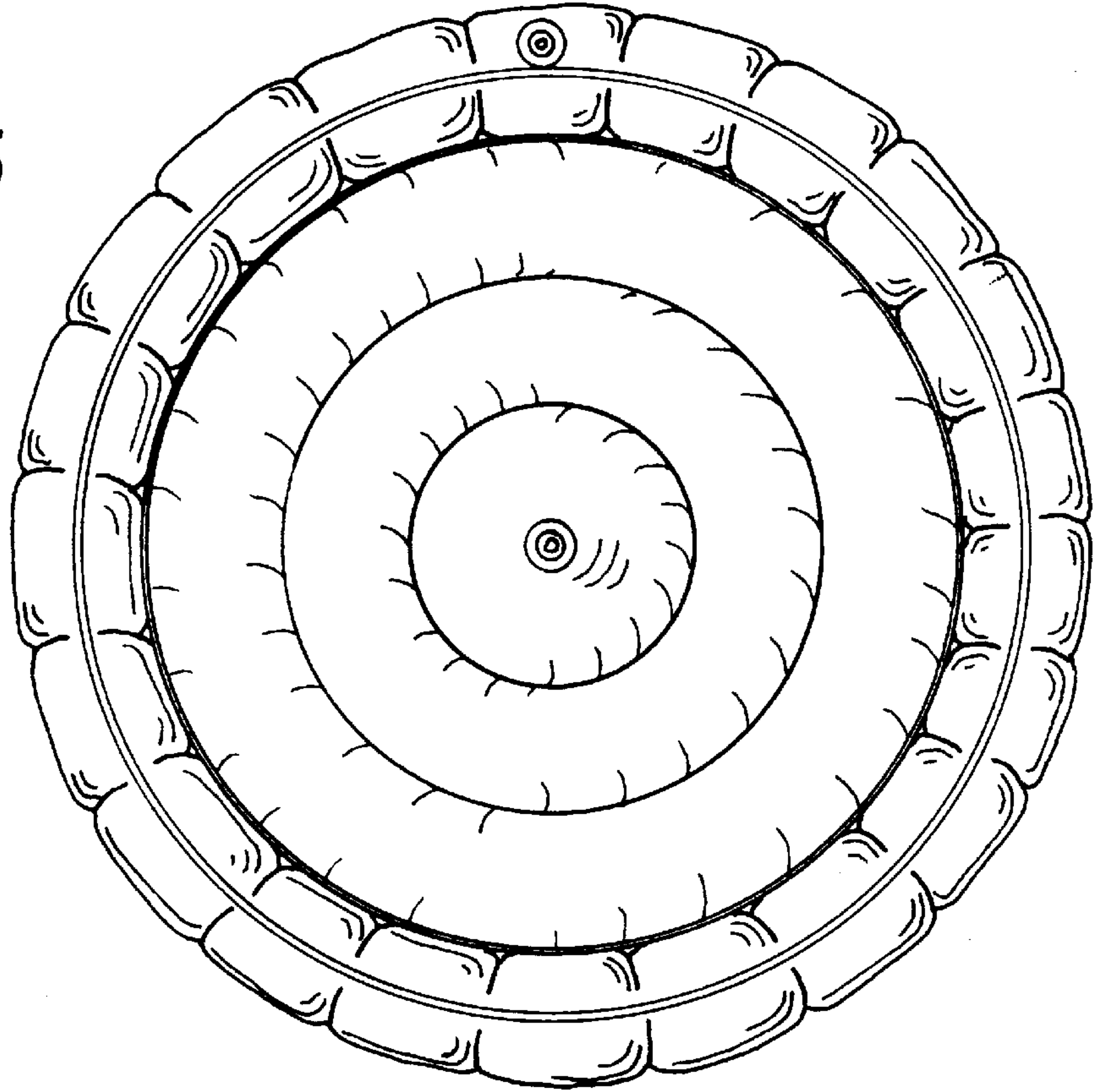

Fig. 6

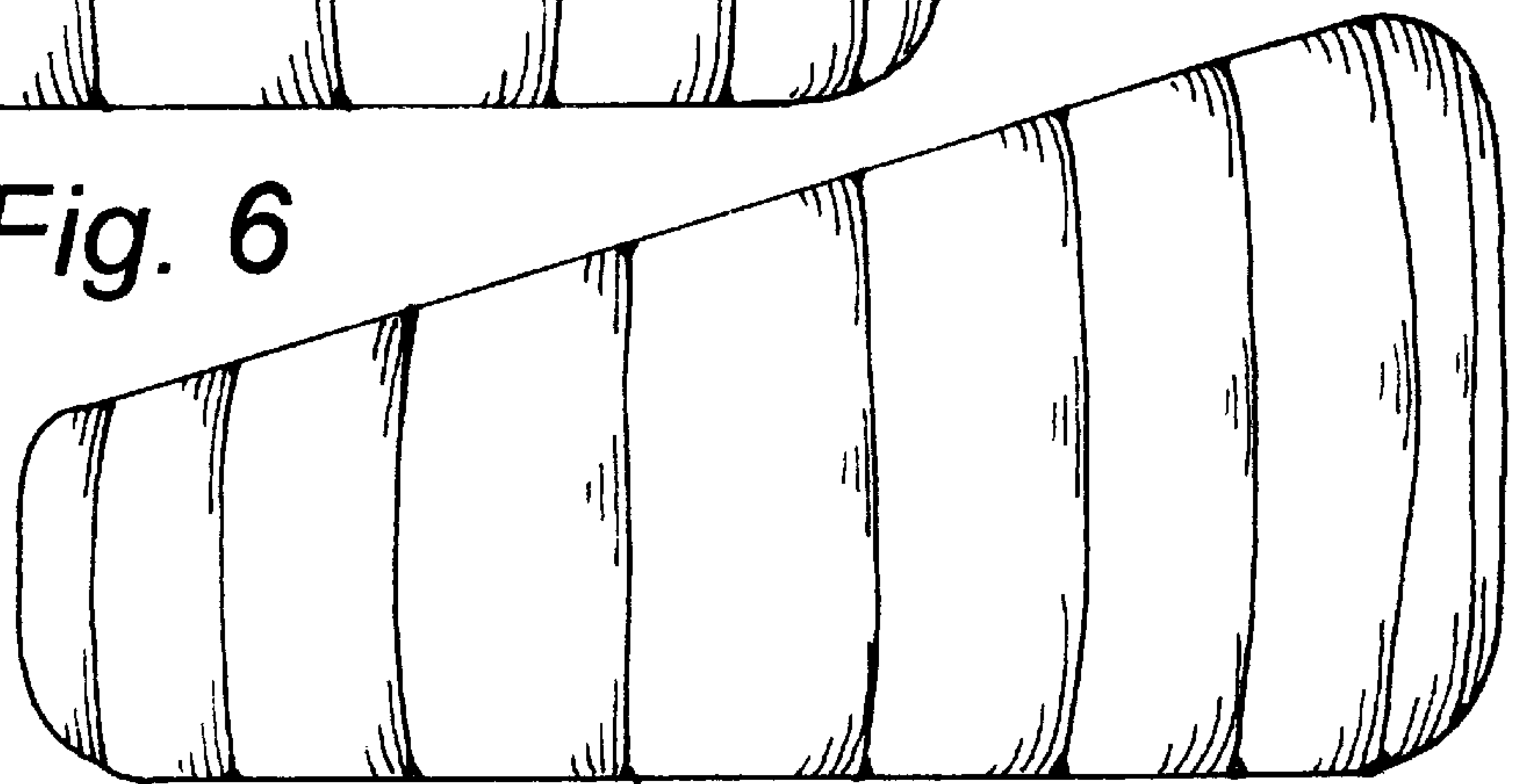

Fig. 7