



US00D430350S

United States Patent [19]
Stachowski

[11] **Patent Number: Des. 430,350**

[45] **Date of Patent: ** Aug. 29, 2000**

[54] **HAIR CLIP**

5,318,054 7/1994 Neilson et al. 132/273
5,495,861 3/1996 Liberman 132/276

[76] Inventor: **Barbara C. Stachowski**, 11 El Gavilan,
Orinda, Calif. 94563

Primary Examiner—Paula A. Mortimer
Attorney, Agent, or Firm—Lumen Intellectual Property
Services

[**] Term: **14 Years**

[21] Appl. No.: **29/097,823**

[57] **CLAIM**

[22] Filed: **Dec. 14, 1998**

The ornamental design for hair clip, as shown and described.

[51] **LOC (7) Cl.** **28-03**

DESCRIPTION

[52] **U.S. Cl.** **D28/39**

[58] **Field of Search** D28/1 P, 93, 39,
D28/40, 41, 42; 132/273, 275, 276, 212;
24/16 PB, 335, 336, 339, 545, 546, 563;
128/869; 156/221; 248/74.3; 281/45

FIG. 1 is a front view of a hair clip showing my new design;
FIG. 2 is a top view thereof;
FIG. 3 is a side view thereof;
FIG. 4 is a bottom view thereof;
FIG. 5 is a perspective view of the hair clip in a position of
use with hair being shown in broken lines;
FIG. 6 is a view of the hair clip in a position of use with a
first hair style, with hair being shown in broken lines;
FIG. 7 is a view of the hair clip in a position of use with a
second hair style, with hair being shown in broken lines;
and,
FIG. 8 is a view of the hair clip in a position of use with a
third hair style, with hair being shown in broken lines.
The broken lines in the figures showing the hair are for
illustrative purposes only and form no part of the claimed
design.

[56] **References Cited**

U.S. PATENT DOCUMENTS

351,941	11/1886	Simmons	24/335
D. 381,120	7/1997	Barkor	D28/41
D. 385,655	10/1997	Jankowski	D28/10
1,489,731	4/1924	Baldwin	24/532
2,014,723	9/1935	Di Carlo	24/546
2,424,740	7/1947	Chamberlain et al.	156/221
2,923,760	2/1960	Famely	248/74.3
3,471,867	10/1969	Kirchhoff	132/273
4,474,383	10/1984	Kikis	132/273
4,858,249	8/1989	Stewart	2/305

1 Claim, 2 Drawing Sheets

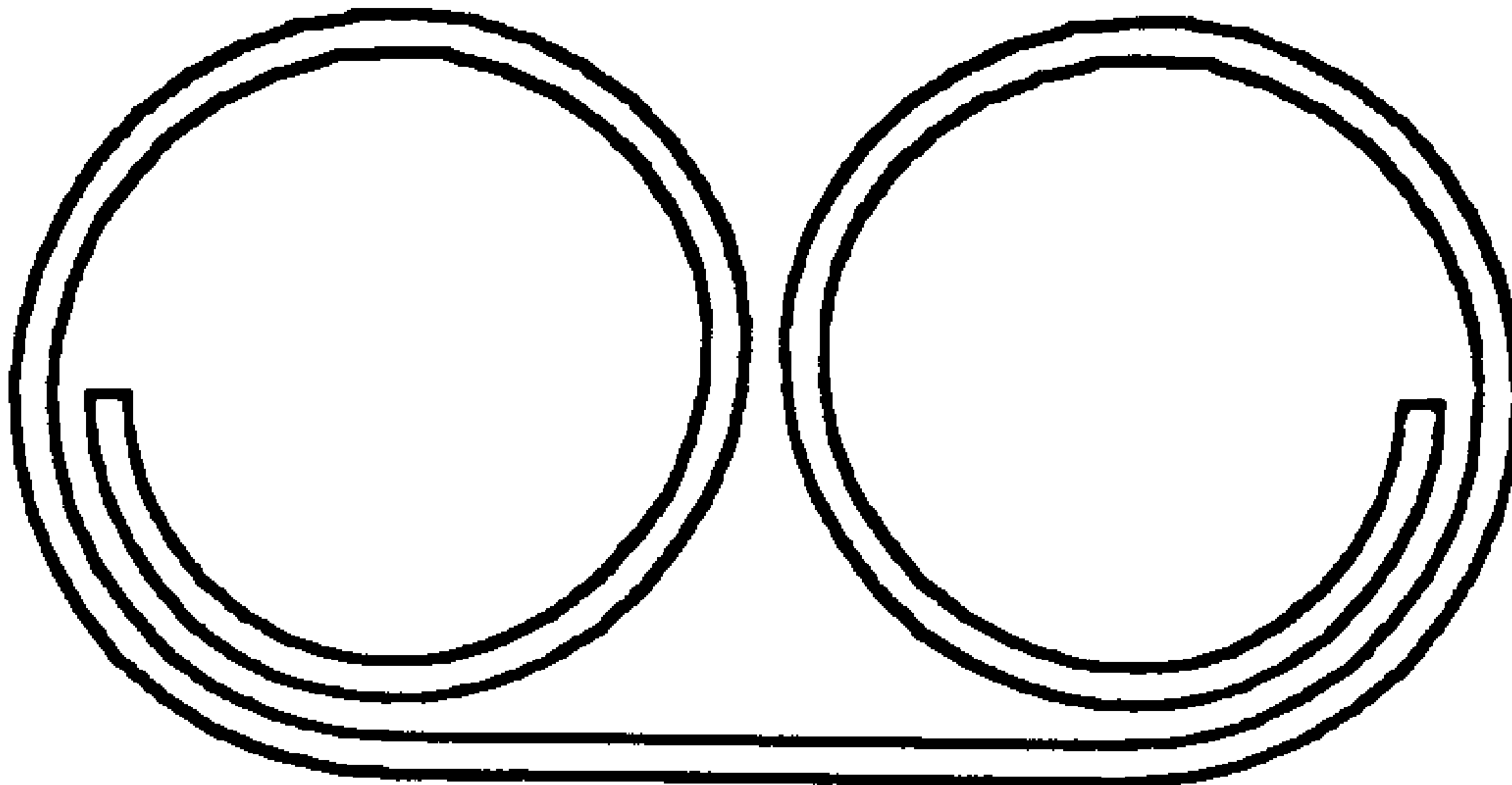

FIG. 1

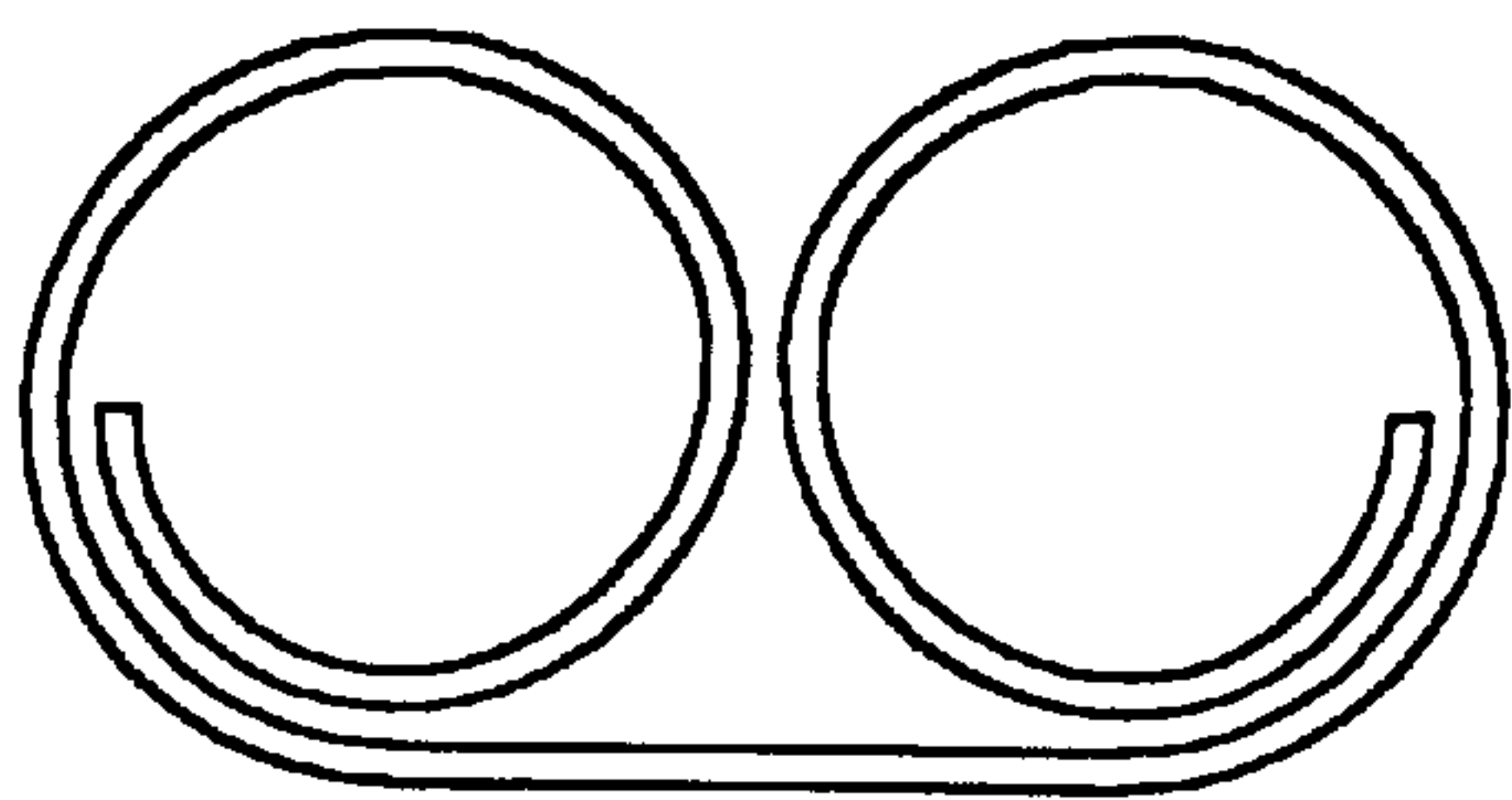

FIG. 2

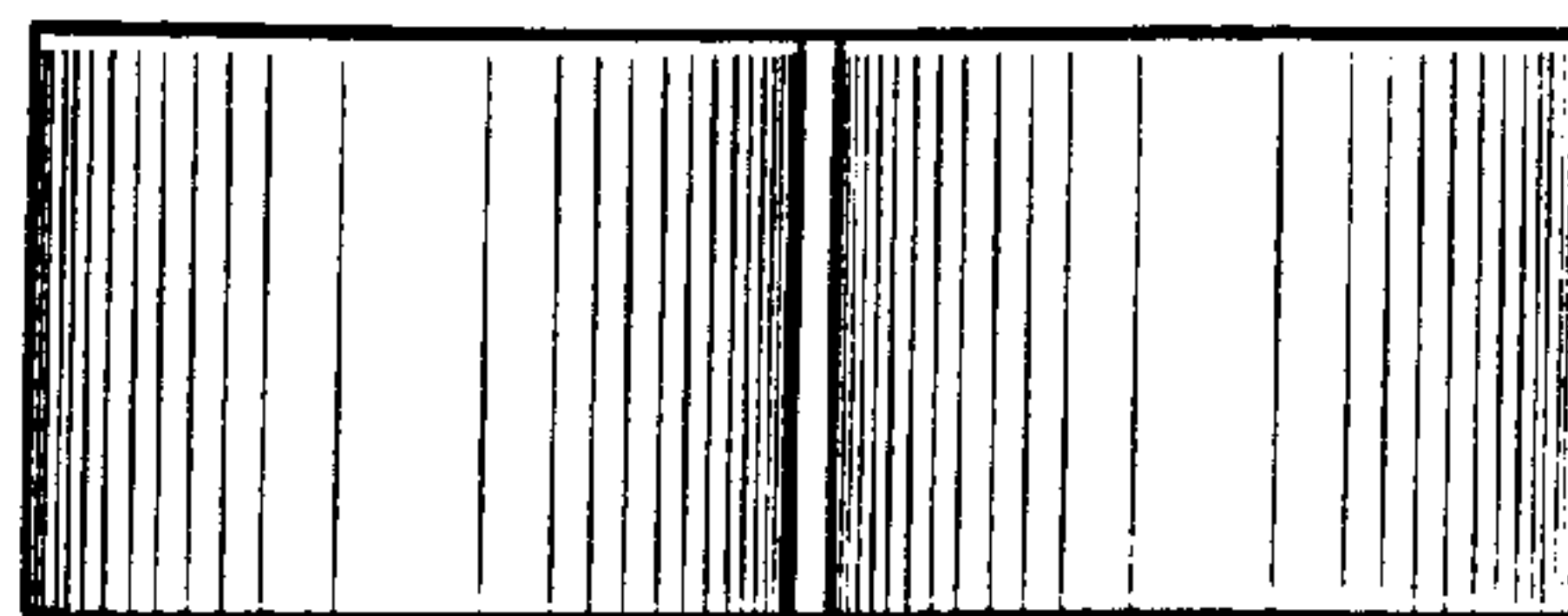

FIG. 3

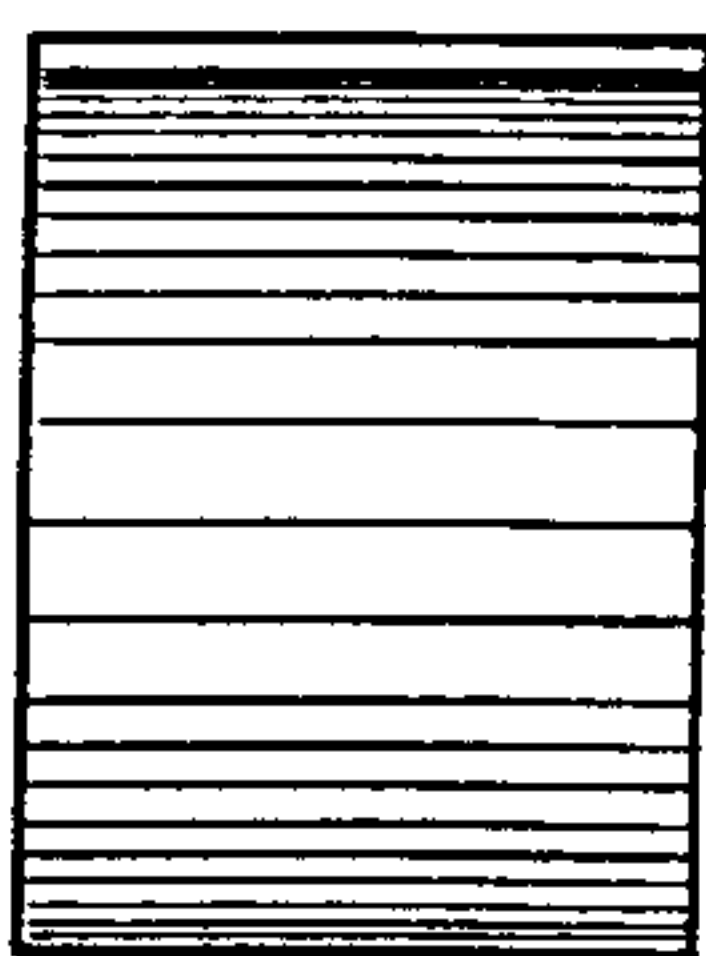

FIG. 4

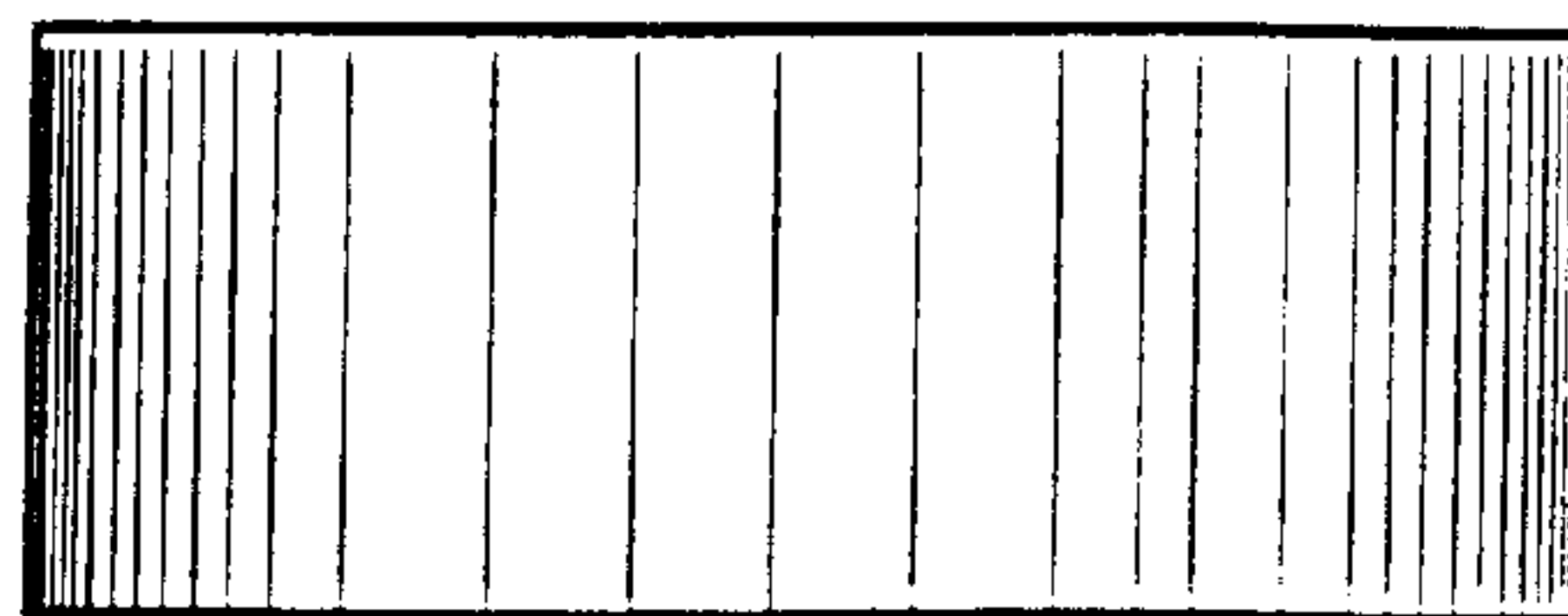
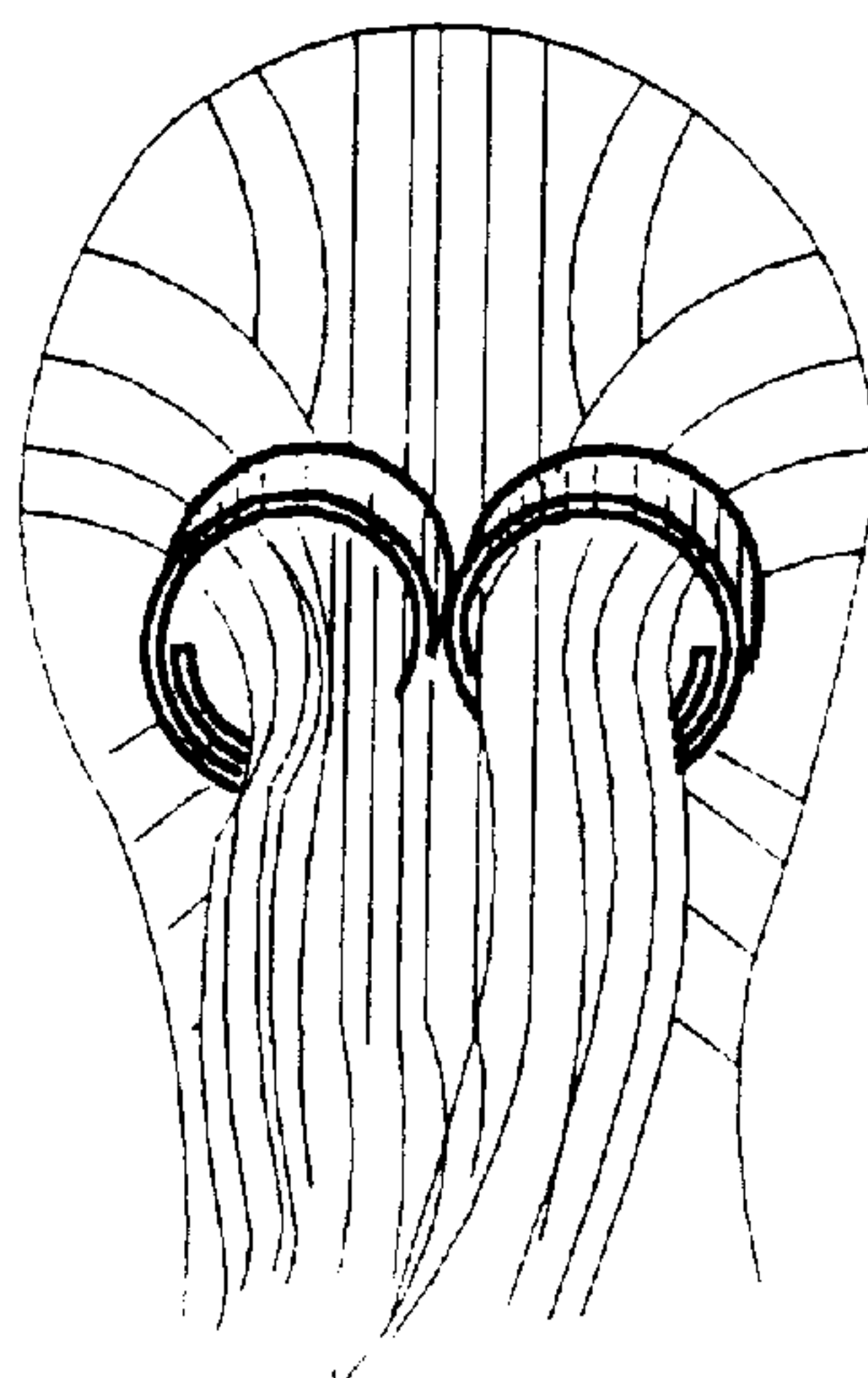

FIG. 8



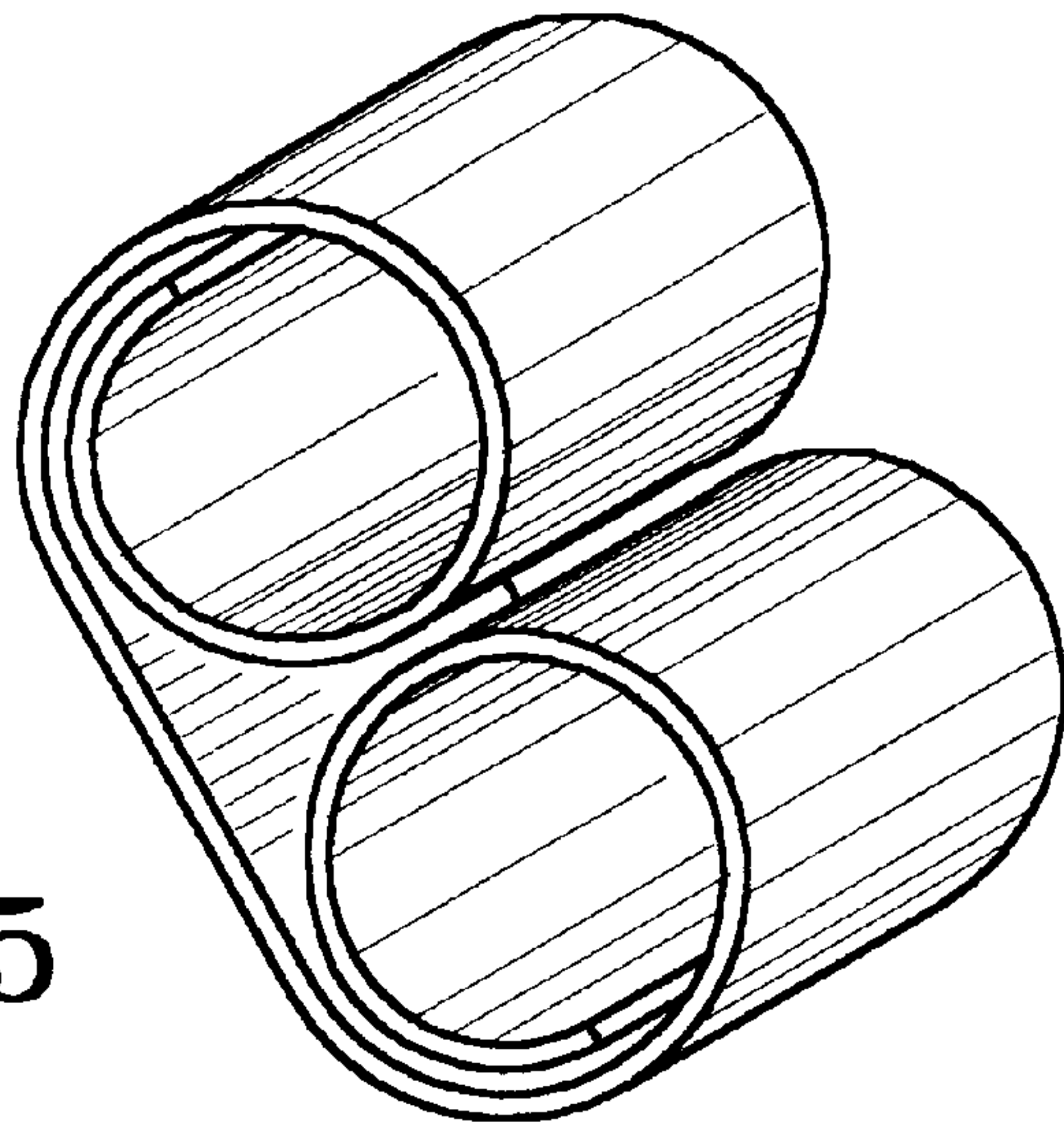

FIG. 5

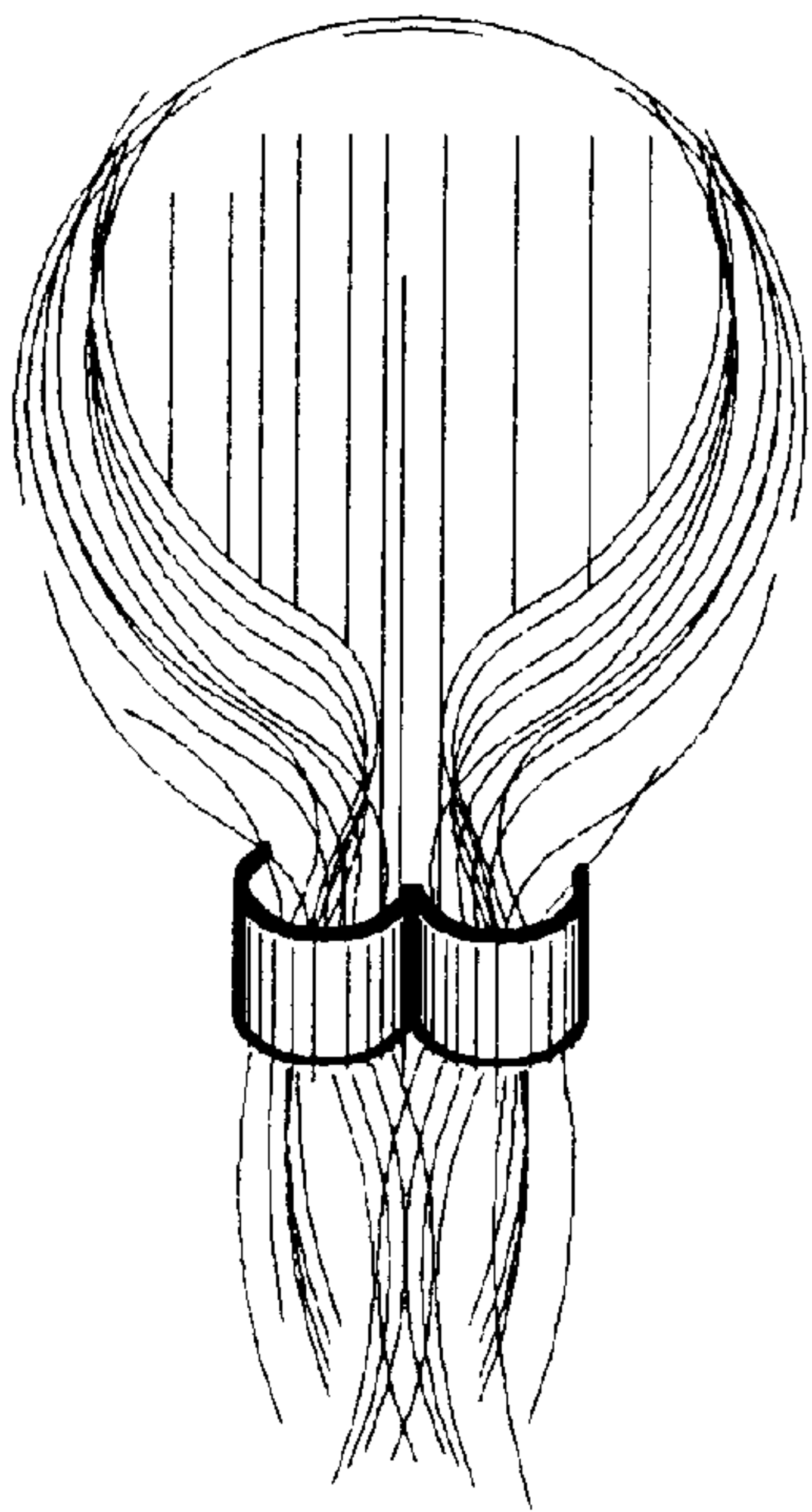

FIG. 6

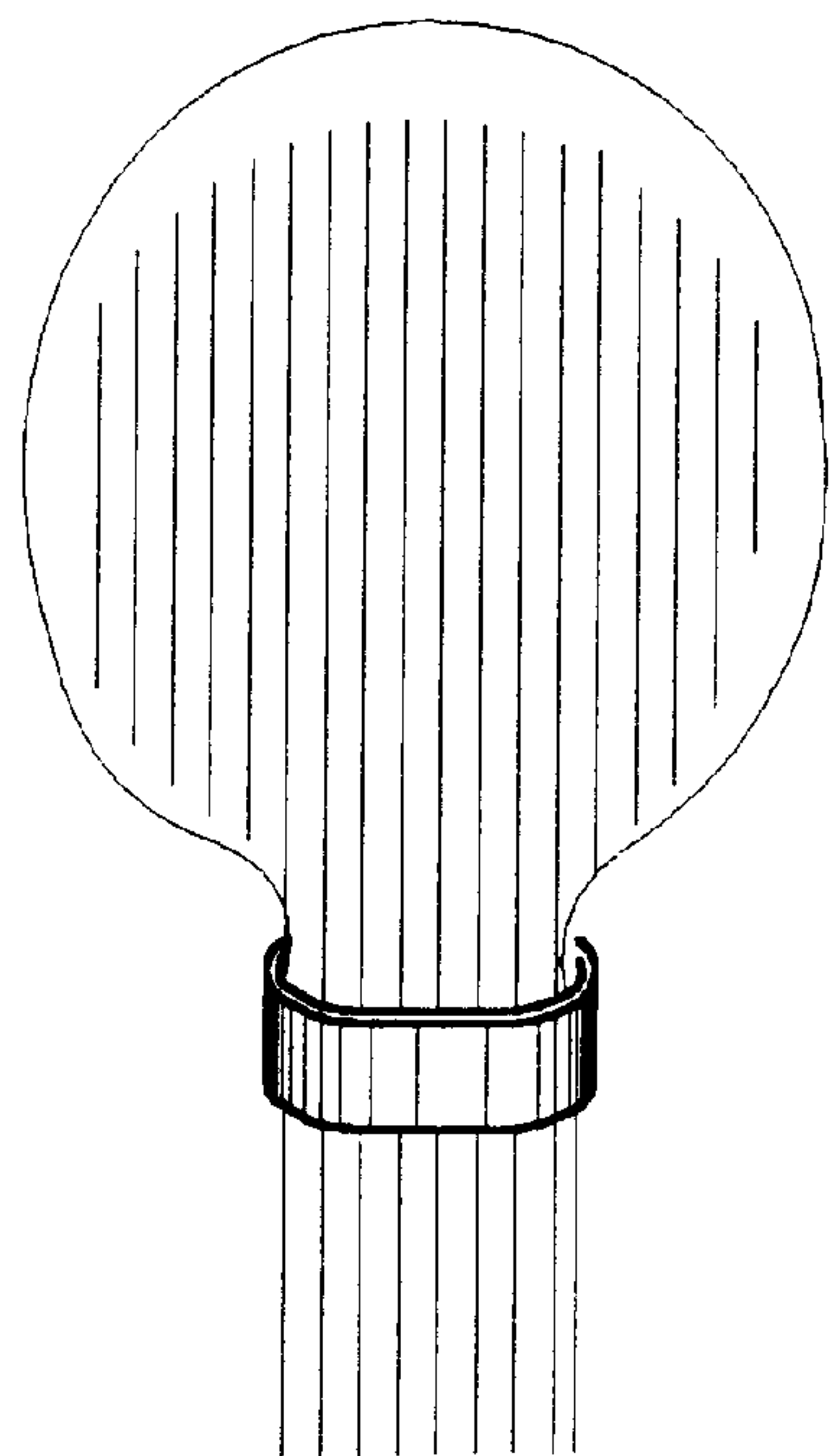

FIG. 7