



US00D430200S

United States Patent [19]

Taneya et al.

[11] **Patent Number: Des. 430,200**

[45] **Date of Patent: ** *Aug. 29, 2000**

[54] **INK TANK FOR PRINTER**

[75] Inventors: **Yoichi Taneya**, Yokohama; **Hiroyuki Ishinaga**, Tokyo; **Hiroyuki Tokuda**, Yokohama; **Tetsuya Sekine**, Kawasaki, all of Japan

[73] Assignee: **Canon Kabushiki Kaisha**, Tokyo, Japan

[*] Notice: This patent is subject to a terminal disclaimer.

[**] Term: **14 Years**

[21] Appl. No.: **29/032,820**

[22] Filed: **Dec. 29, 1994**

[30] **Foreign Application Priority Data**

Jul. 5, 1994 [JP] Japan 6-19893

[51] **LOC (7) Cl.** **18-02**

[52] **U.S. Cl.** **D18/56; 347/86**

[58] **Field of Search** **D18/56; 347/86, 347/87**

D. 367,884 3/1996 Taneya et al. D18/56
D. 371,389 7/1996 Taneya et al. D18/56
D. 372,732 8/1996 Taneya et al. D18/56
D. 392,671 3/1998 Sasaki D18/56

Primary Examiner—Cathy Anne MacCormac
Attorney, Agent, or Firm—Fitzpatrick, Cella, Harper & Scinto

[57] **CLAIM**

The ornamental design for an ink tank for printer, as shown and described.

DESCRIPTION

FIG. 1 is a front elevational view of an ink tank for printer showing our new design;

FIG. 2 is a rear elevational view thereof;

FIG. 3 is a top plan view thereof;

FIG. 4 is a bottom plan view thereof;

FIG. 5 is a left side elevational view thereof;

FIG. 6 is a right side elevational view thereof; and,

FIG. 7 is a perspective view thereof.

[56] **References Cited**

U.S. PATENT DOCUMENTS

D. 356,110 3/1995 Tokuda et al. D18/56

1 Claim, 3 Drawing Sheets

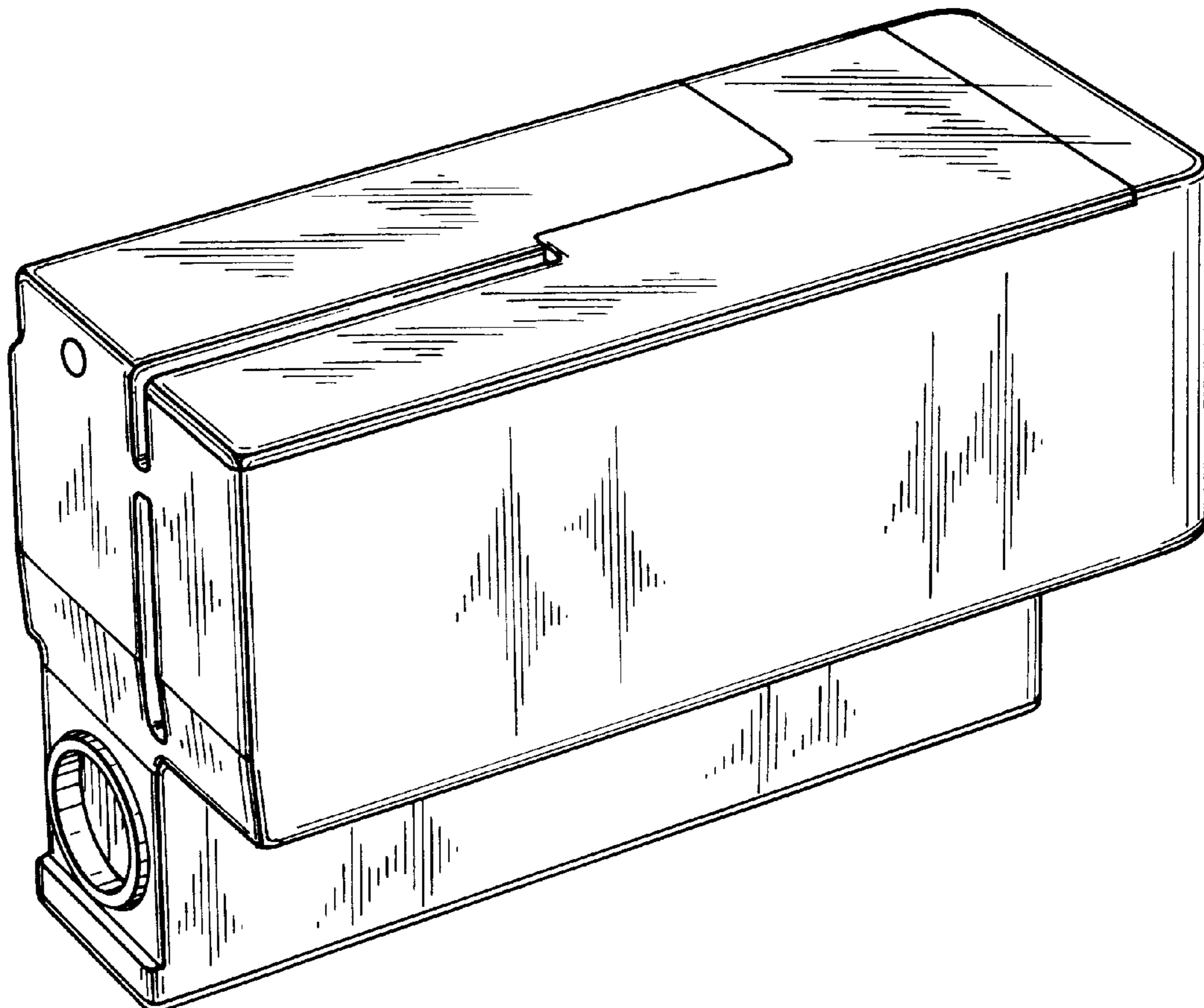

FIG. 1

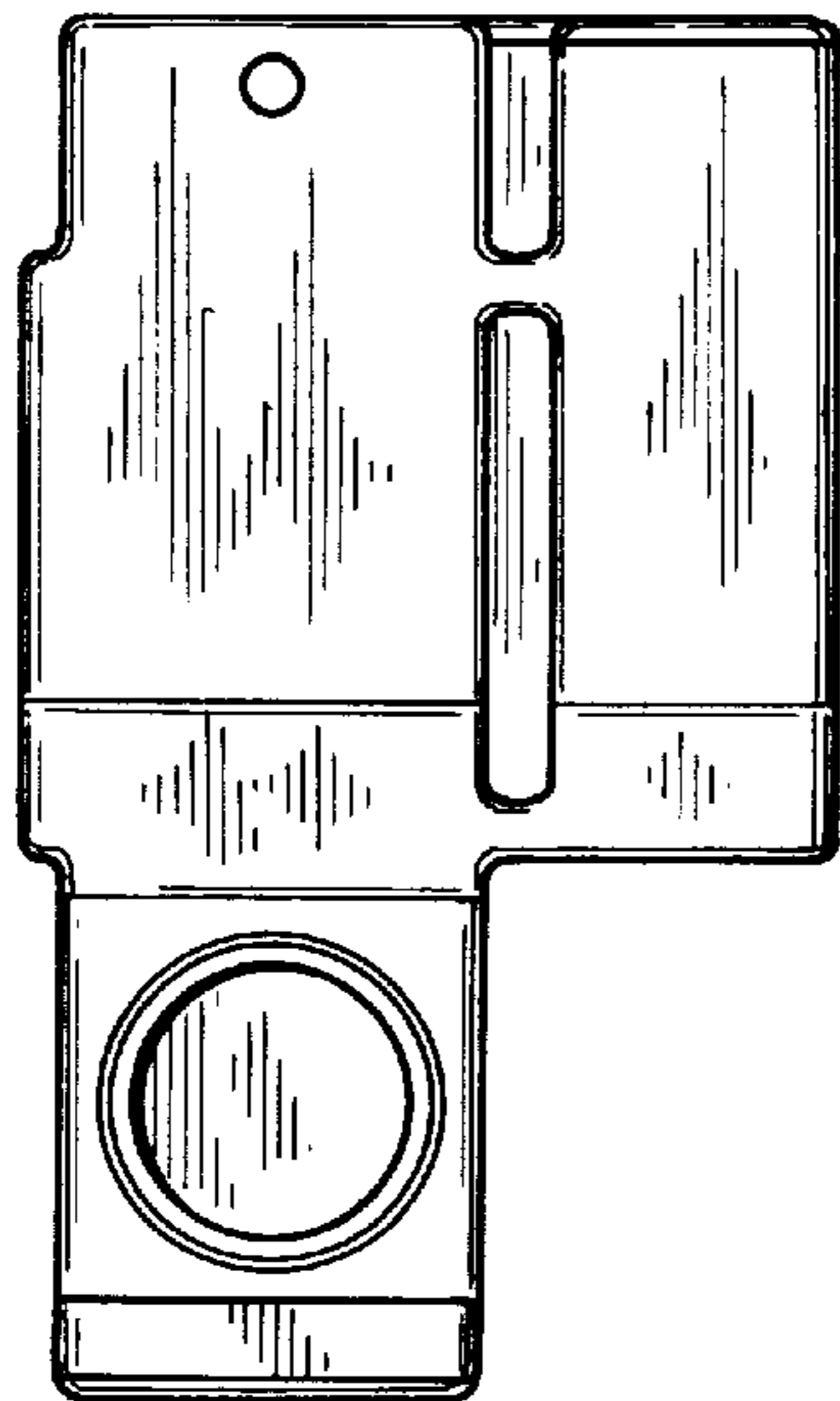

FIG. 2

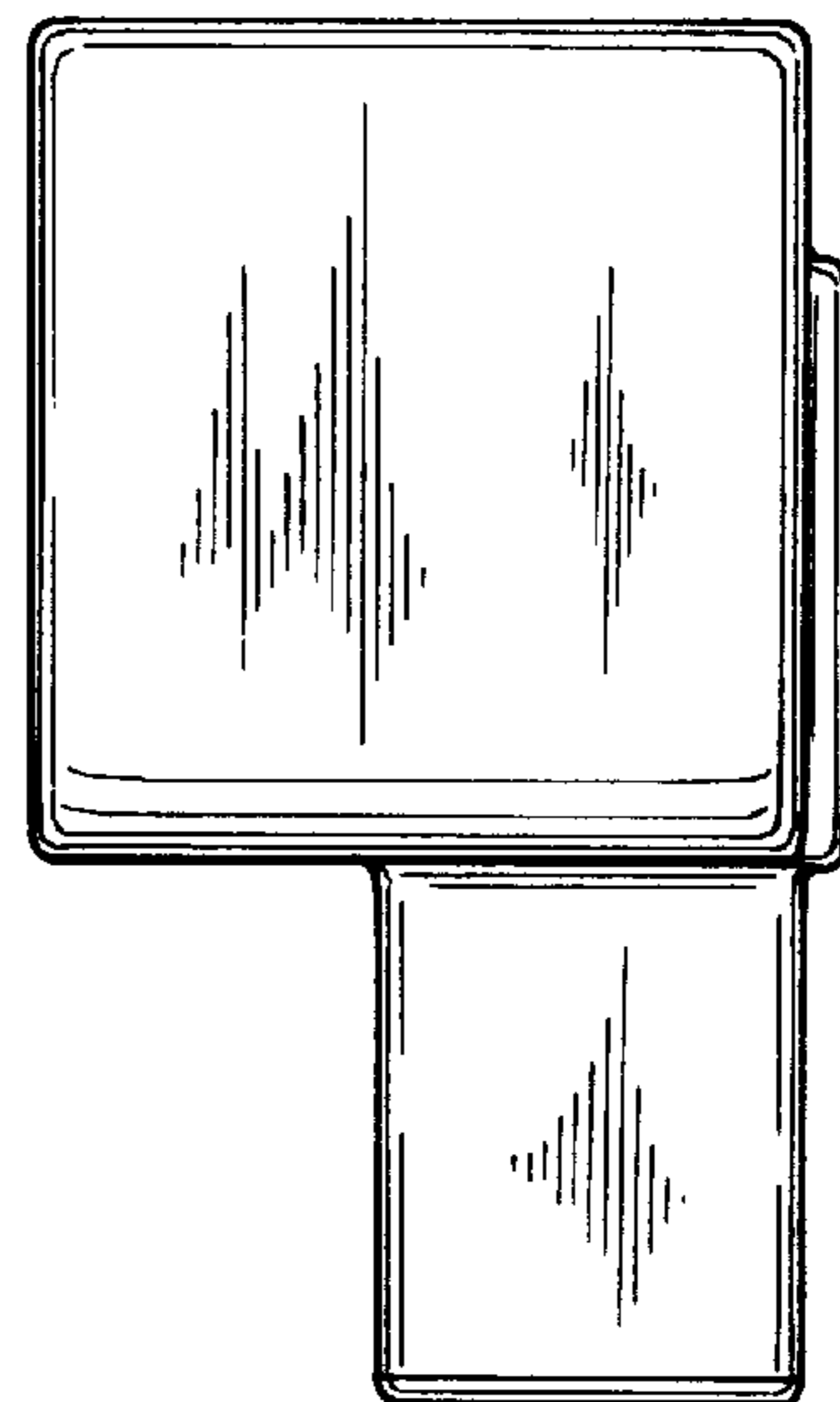

FIG. 3

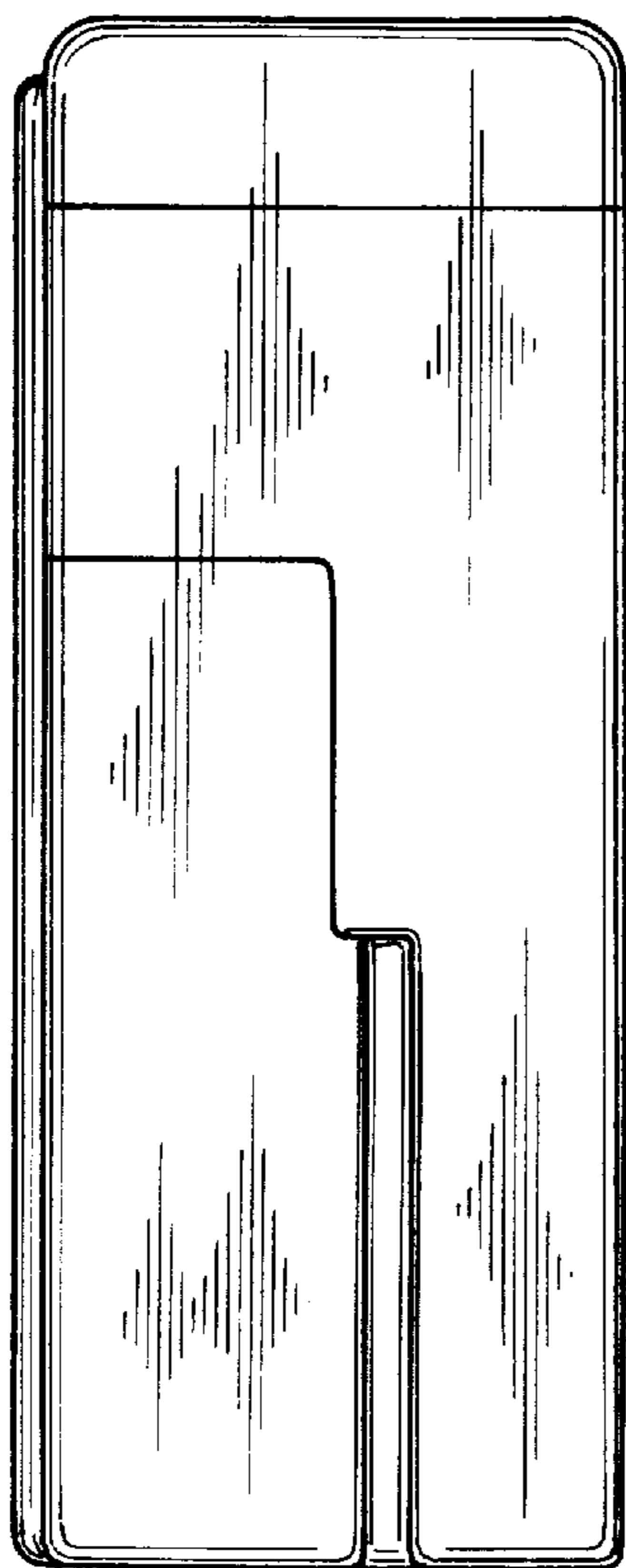

FIG. 4

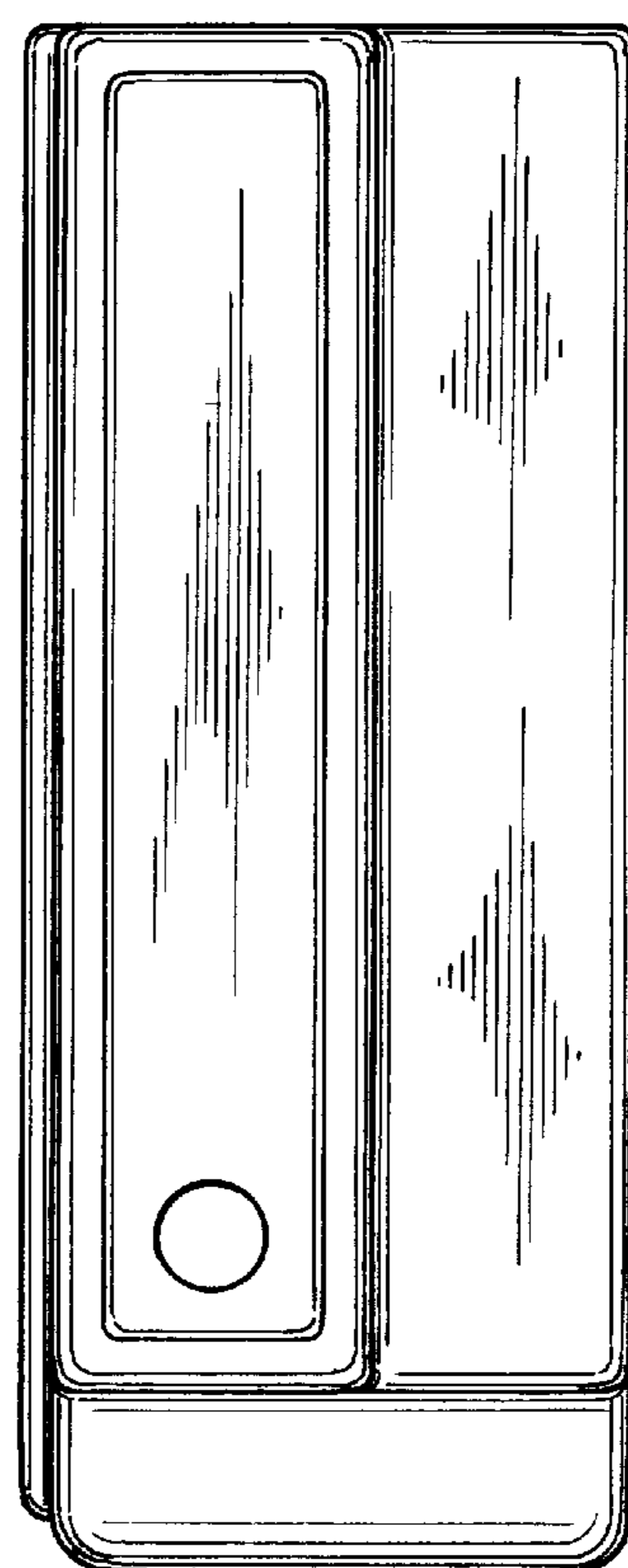

FIG. 5

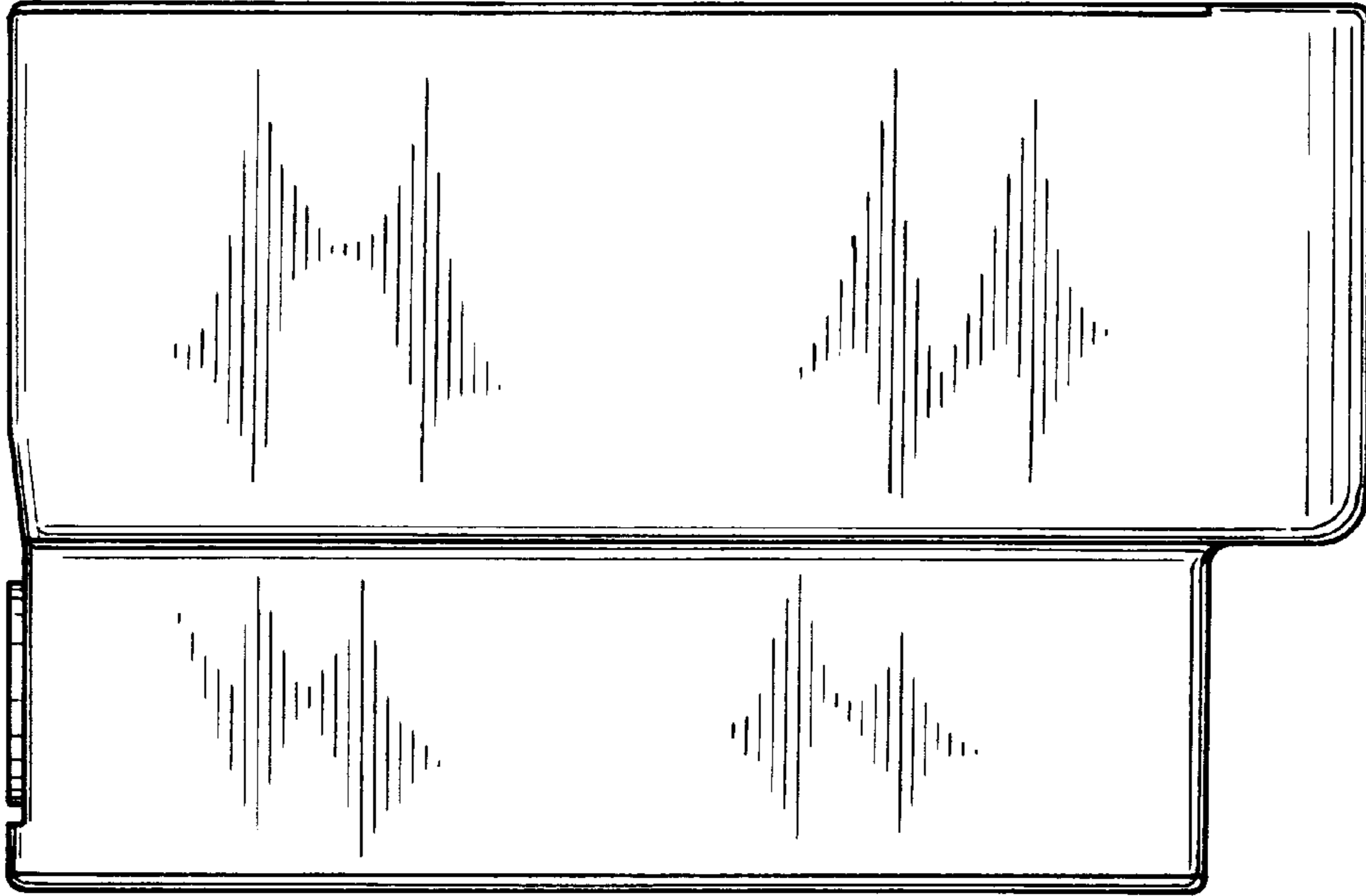

FIG. 6

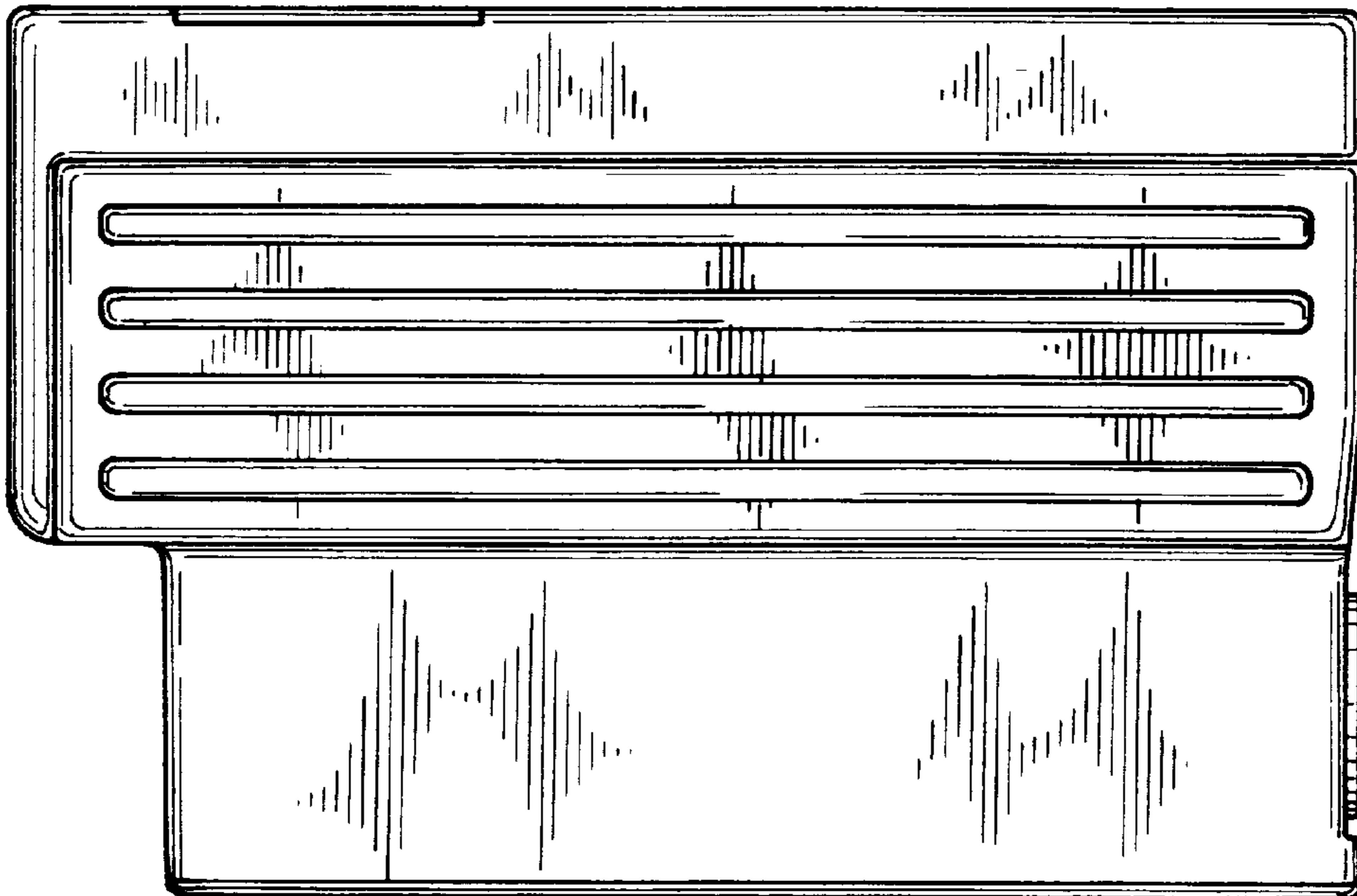

FIG. 7

