



US00D430172S

United States Patent [19]
Kesavan

[11] **Patent Number: Des. 430,172**

[45] **Date of Patent: ** Aug. 29, 2000**

[54] **REPLACEABLE WEAR TIP**

DESCRIPTION

[75] Inventor: **Arun Kesavan**, Peoria, Ill.

[73] Assignee: **Caterpillar Inc.**, Peoria, Ill.

[**] Term: **14 Years**

[21] Appl. No.: **29/110,091**

[22] Filed: **Aug. 30, 1999**

[51] **LOC (7) Cl.** **15-04**

[52] **U.S. Cl.** **D15/28**

[58] **Field of Search** D15/10, 21-26,
D15/28-29, 32; 37/421, 442, 455; 404/121,
124

[56] **References Cited**

U.S. PATENT DOCUMENTS

H946	8/1991	Lonn	404/121
D. 338,898	8/1993	Corcoran et al.	D15/28
3,274,908	9/1966	Grant et al.	404/121
4,074,942	2/1978	Cochran	404/121
4,481,728	11/1984	Mulder et al.	37/452
5,217,321	6/1993	Corcoran et al.	404/121
5,217,322	6/1993	Corcoran et al.	404/121
5,358,355	10/1994	Brockway	404/121

Primary Examiner—Sandra L. Morris
Attorney, Agent, or Firm—August E. Roehrig, Jr.

[57] **CLAIM**

The ornamental design for a replaceable wear tip, as shown and described.

FIG. 1 is a front perspective view of the replaceable wear tip of our invention;
 FIG. 2 is a top planar view of the replaceable wear tip illustrated in FIG. 1;
 FIG. 3 is a frontal elevational view of the replaceable wear tip illustrated in FIG. 1, the rear elevational view being a mirror image thereof;
 FIG. 4 is a right side elevational view of the replaceable wear tip illustrated in FIG. 1, the left side elevational view being a mirror image thereof;
 FIG. 5 is a bottom planar view of the replaceable wear tip illustrated in FIG. 1;
 FIG. 6 is a cross sectional view of the replaceable wear tip taken along lines 6—6 of FIG. 3 to better illustrate the contours thereof; and
 FIG. 7 is a cross sectional view of the replaceable wear tip taken along line 7—7 of FIG. 4 to better illustrate the contours thereof.
 FIG. 8 is a front perspective view of an alternative embodiment of the replaceable wear tip of our invention;
 FIG. 9 is a top planar view of the alternative embodiment of the replaceable wear tip illustrated in FIG. 8;
 FIG. 10 is a frontal elevational view of the alternative embodiment of the replaceable wear tip shown in FIG. 8, the rear elevational view being a mirror image thereof; and,
 FIG. 11 is a right side elevational view of the alternative embodiment of the replaceable wear tip illustrated in FIG. 8, the left side elevational view being a mirror image thereof. The bottom of the replaceable wear tip is not seen when in use.

1 Claim, 11 Drawing Sheets

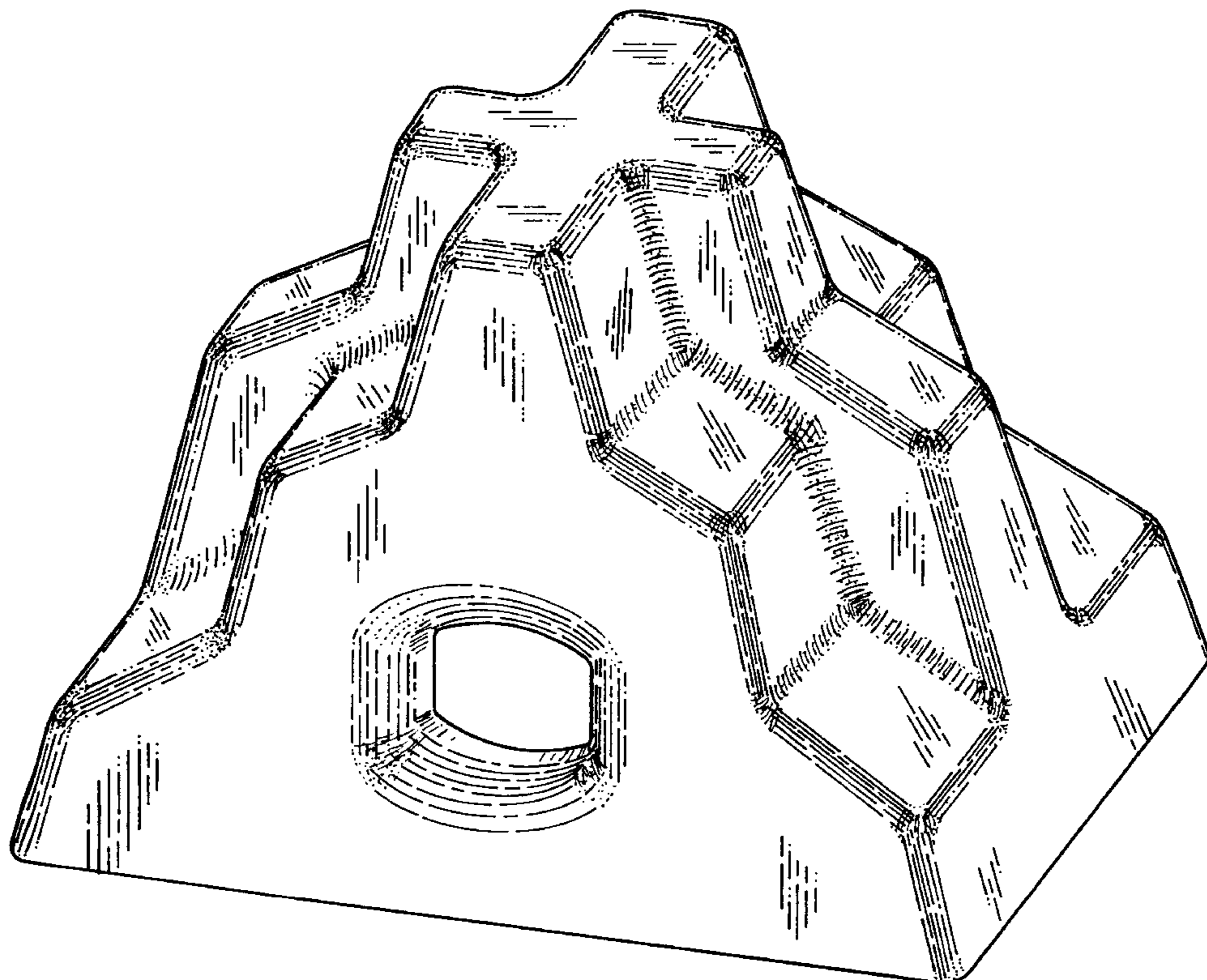

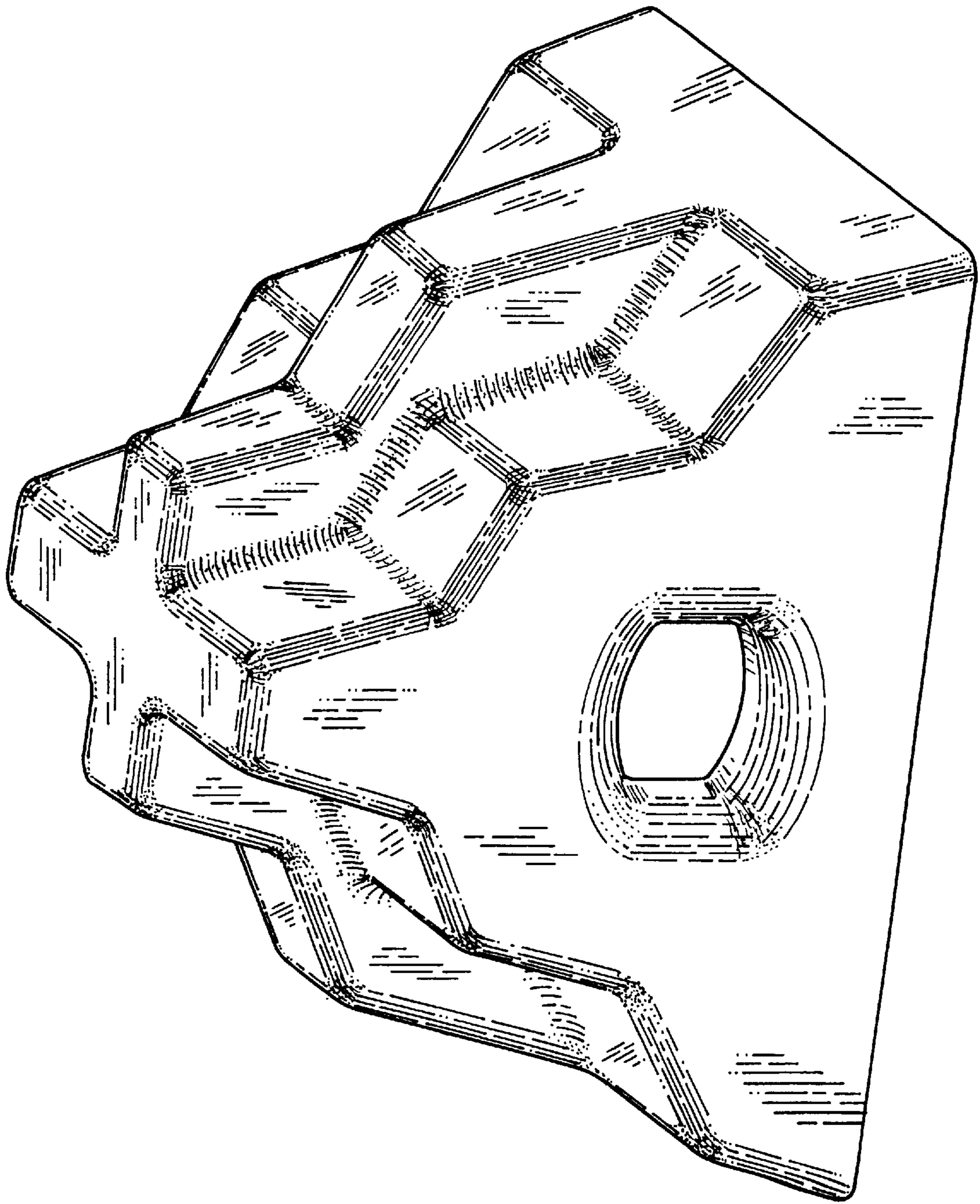

FIG. 1

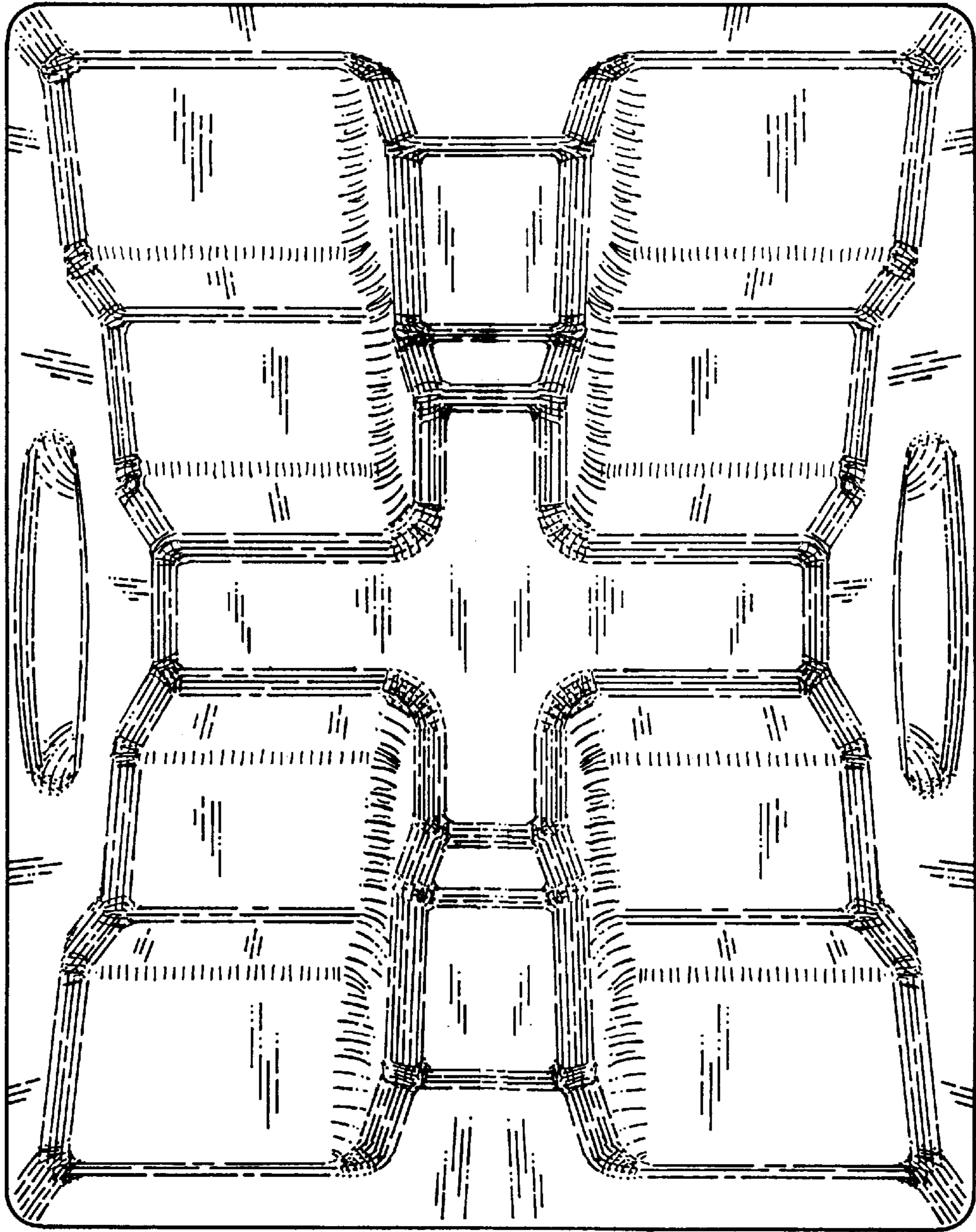
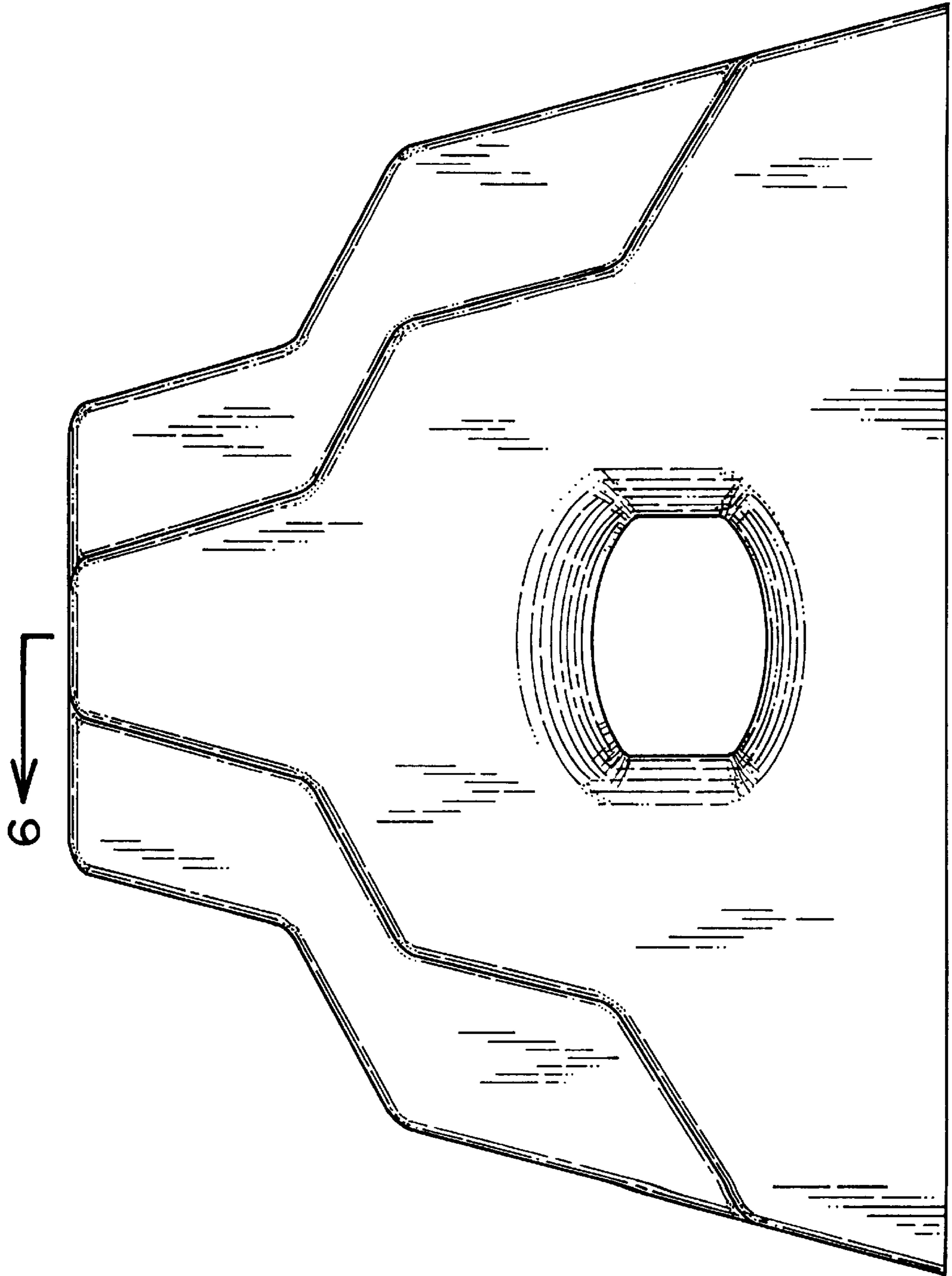
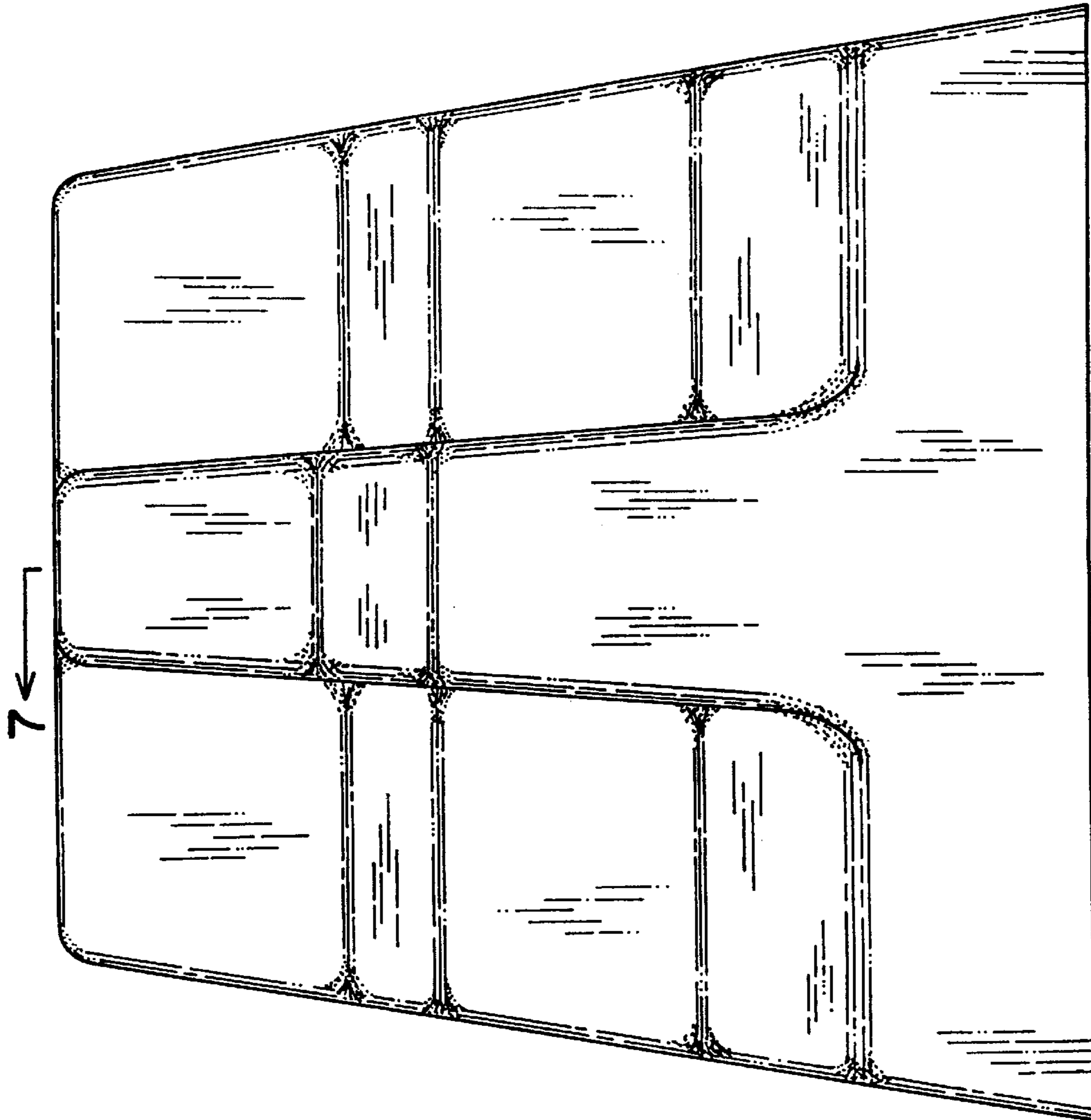

FIG. 2





7 ←

7 ←

FIG. 4

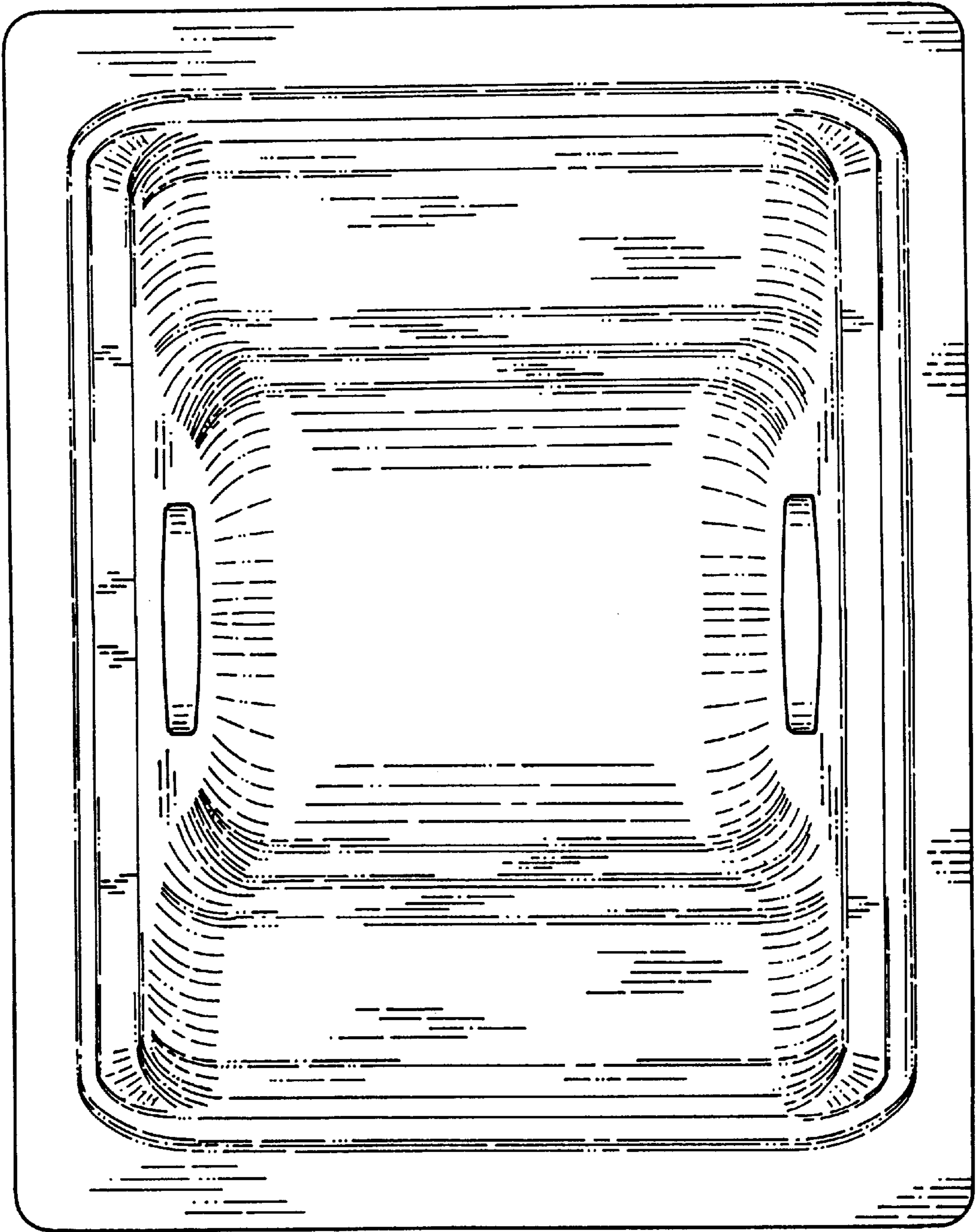

FIG. 5

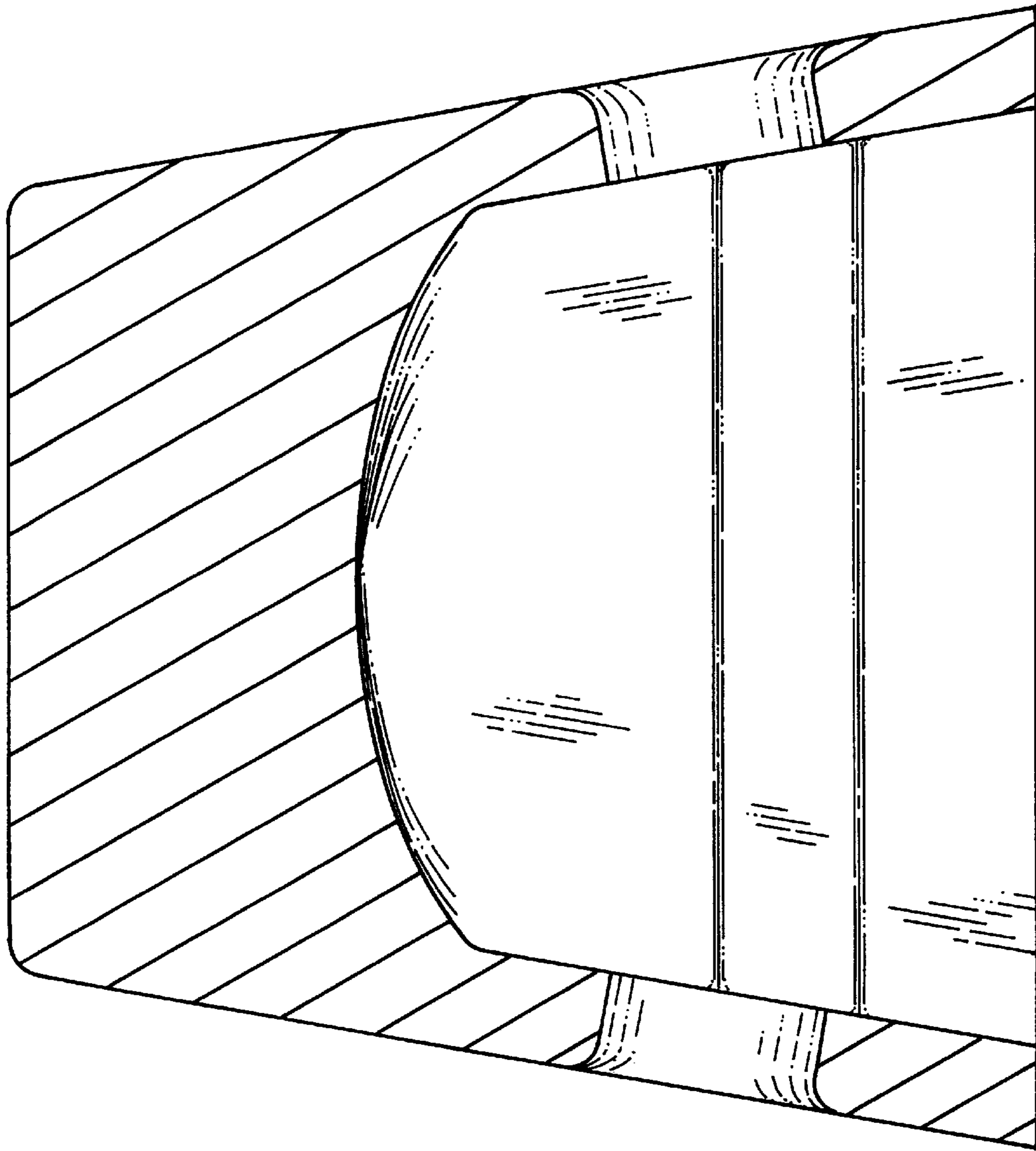

FIG. 6

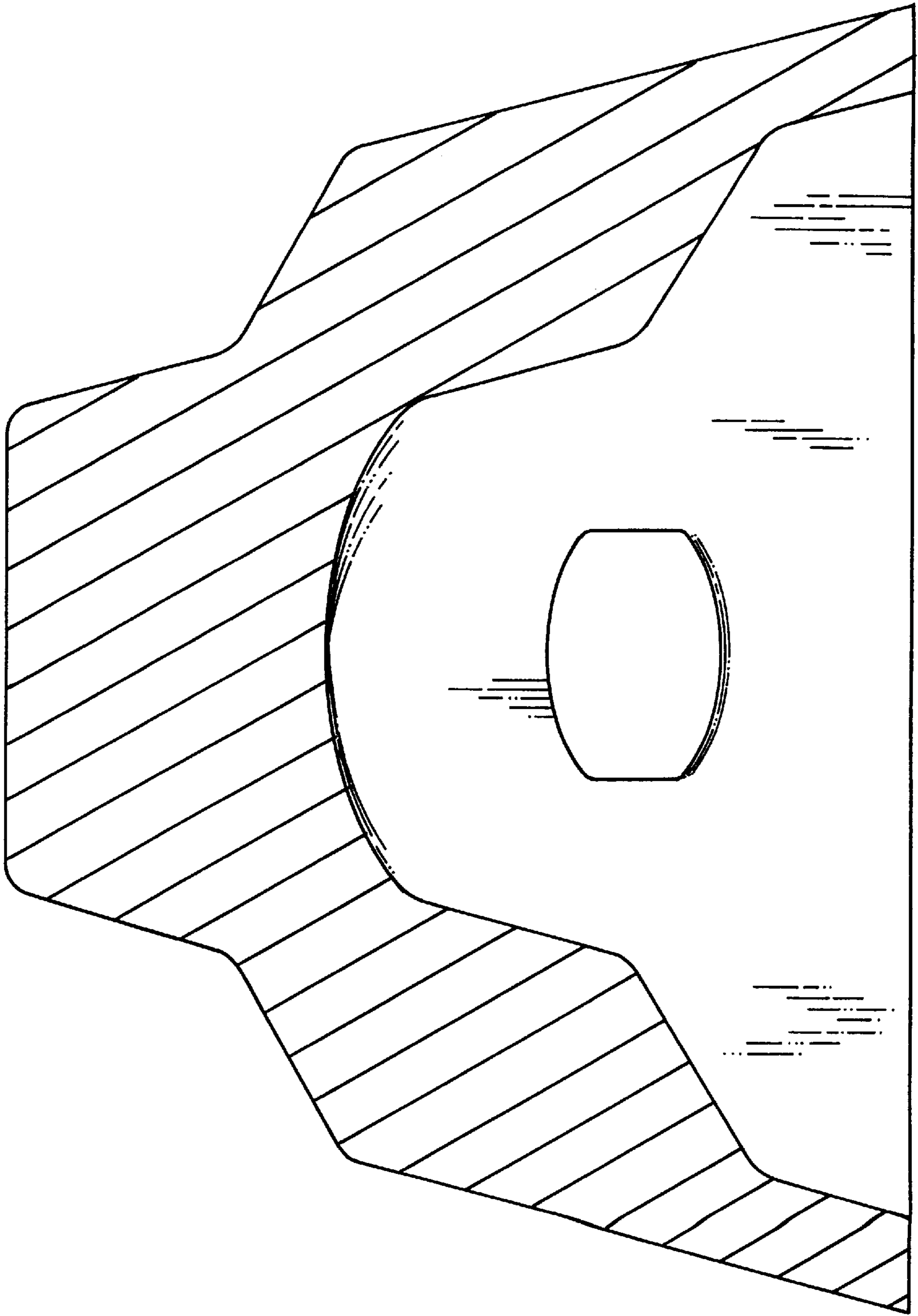

FIG. 7

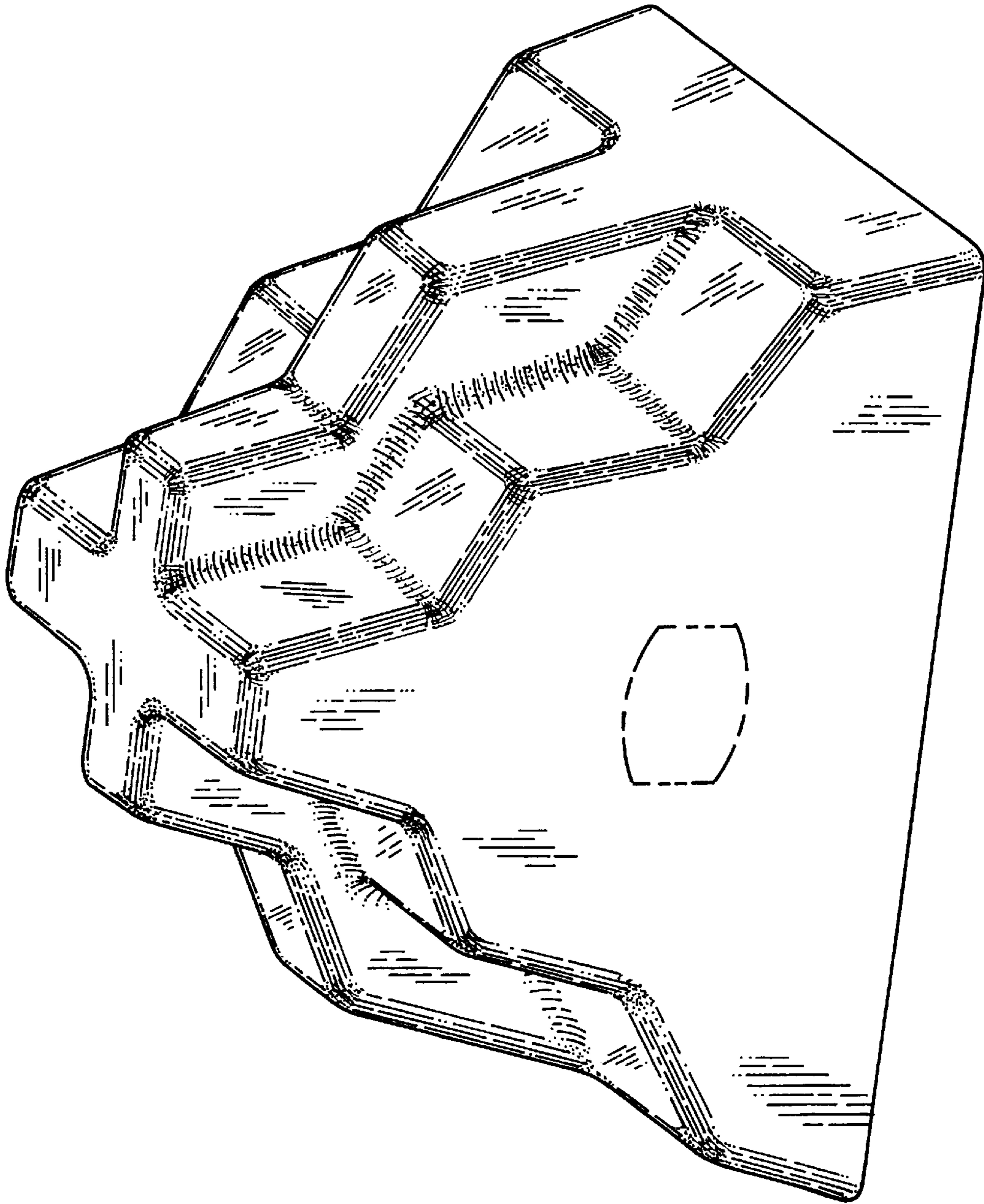

FIG. 8

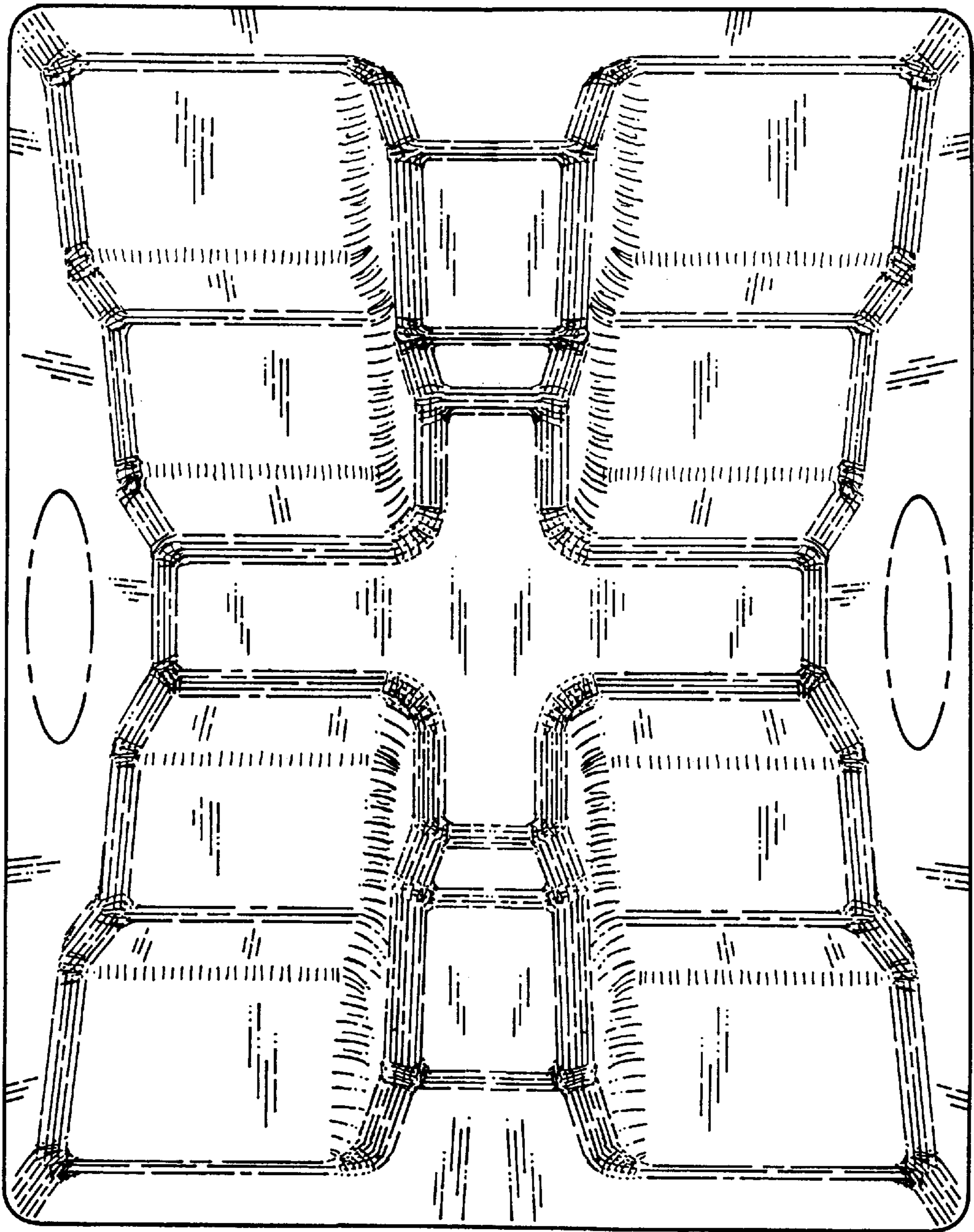

FIG. 9

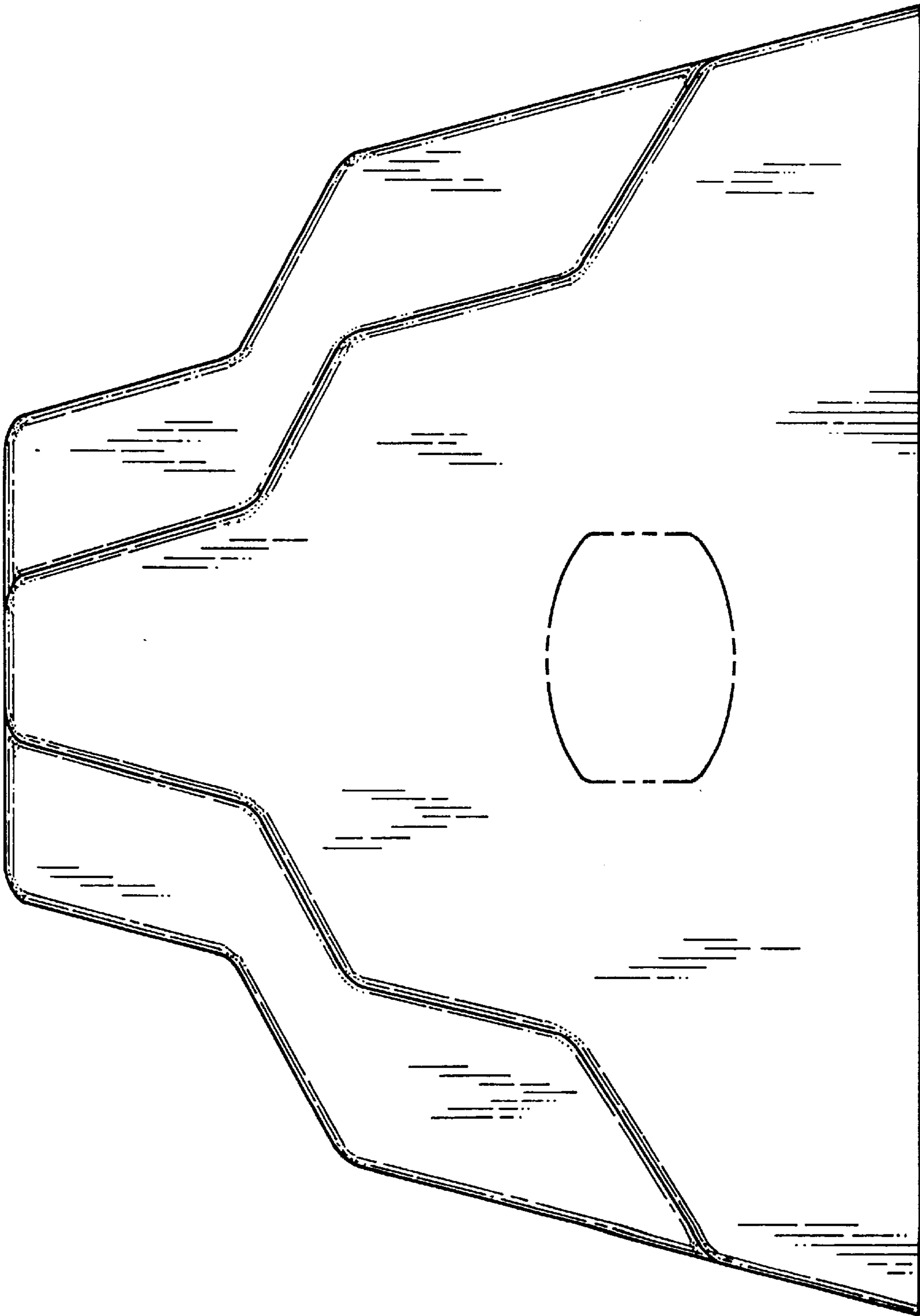

FIG. 10

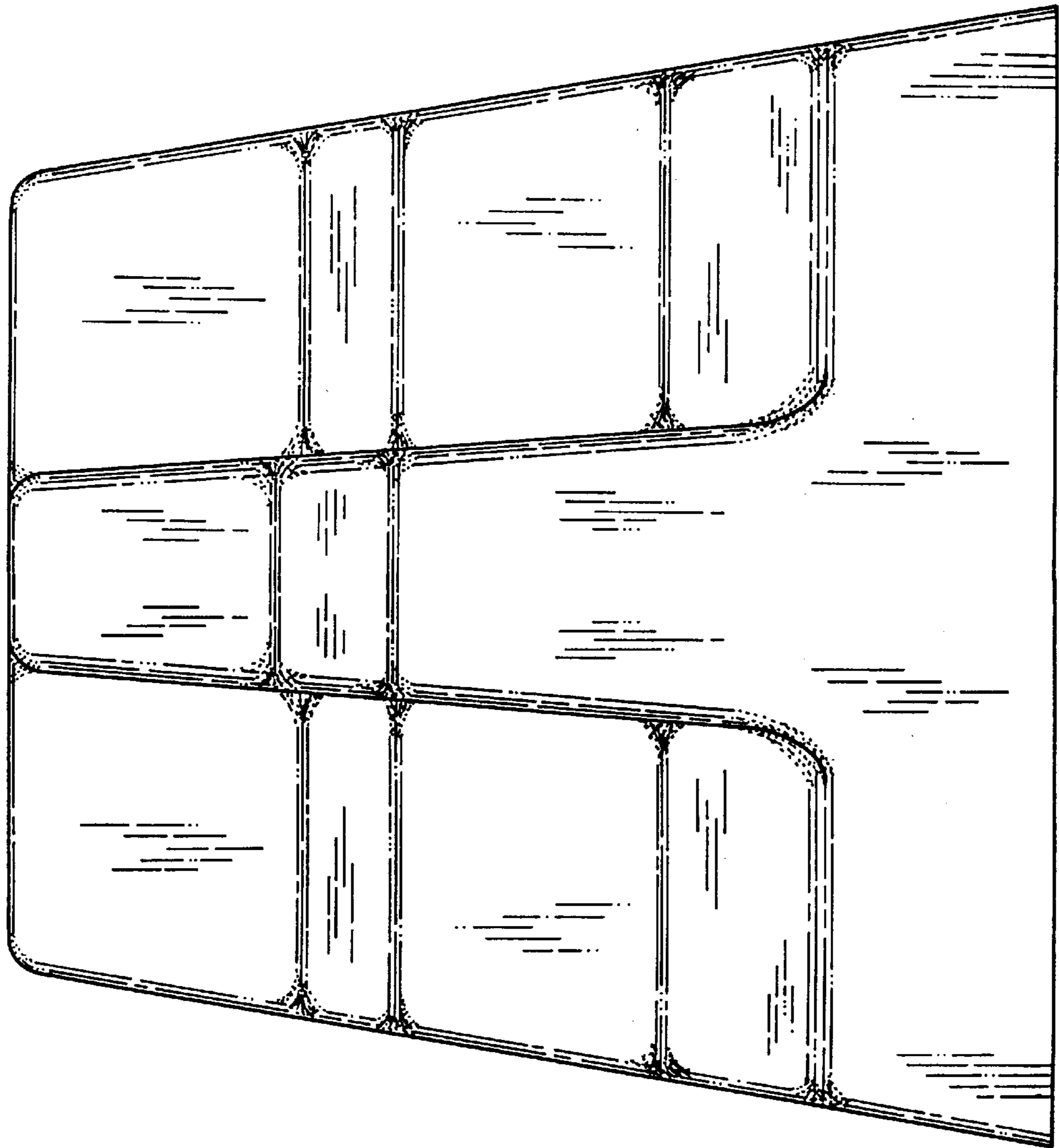

FIG. 11