



US00D430117S

United States Patent [19]

Sachs et al.

[11] Patent Number: Des. 430,117

[45] Date of Patent: ** Aug. 29, 2000

[54] ELECTRONIC BOOK

[75] Inventors: **James Sachs**, Menlo Park; **Thomas W. Pomeroy**, Atherton; **Phil Hobson**, Los Altos; **Joost Godee**; **David William Laituri**, both of Palo Alto, all of Calif.

[73] Assignee: **SoftBook Press, Inc.**, Menlo Park, Calif.

[**] Term: **14 Years**

[21] Appl. No.: **29/078,048**

[22] Filed: **Oct. 16, 1997**

[51] LOC (7) Cl. **14-02**

[52] U.S. Cl. **D14/100**

[58] Field of Search D14/100, 106, D14/115, 114; D19/26, 59, 60; 345/104, 156, 173; 364/708.1; 349/12; 24/67.9

[56] References Cited

U.S. PATENT DOCUMENTS

273,301	3/1883	Page et al.	24/67.9
D. 326,446	5/1992	Wong	D14/100
D. 359,306	6/1995	Lande et al.	D19/26

Primary Examiner—Freda Nunn
Attorney, Agent, or Firm—Blakely, Sokoloff, Taylor & Zafman LLP

[57] CLAIM

The ornamental design for an electronic book, as shown and described.

DESCRIPTION

FIG. 1 is a perspective view of the electronic book showing our new design with the cover closed;
FIG. 2 is a first side elevational view thereof;
FIG. 3 is a second side elevational view thereof;
FIG. 4 is a front elevational view thereof;
FIG. 5 is a rear elevational view thereof;
FIG. 6 is a bottom plan view thereof;
FIG. 7 is a perspective view of the electronic book showing our new design with the cover open;
FIG. 8 is a top plan view thereof;
FIG. 9 is a front elevational view thereof;
FIG. 10 is a rear elevational view thereof;
FIG. 11 is a bottom plan view thereof;
FIG. 12 is a first side elevational view thereof; and,
FIG. 13 is a second elevational view thereof.

1 Claim, 7 Drawing Sheets

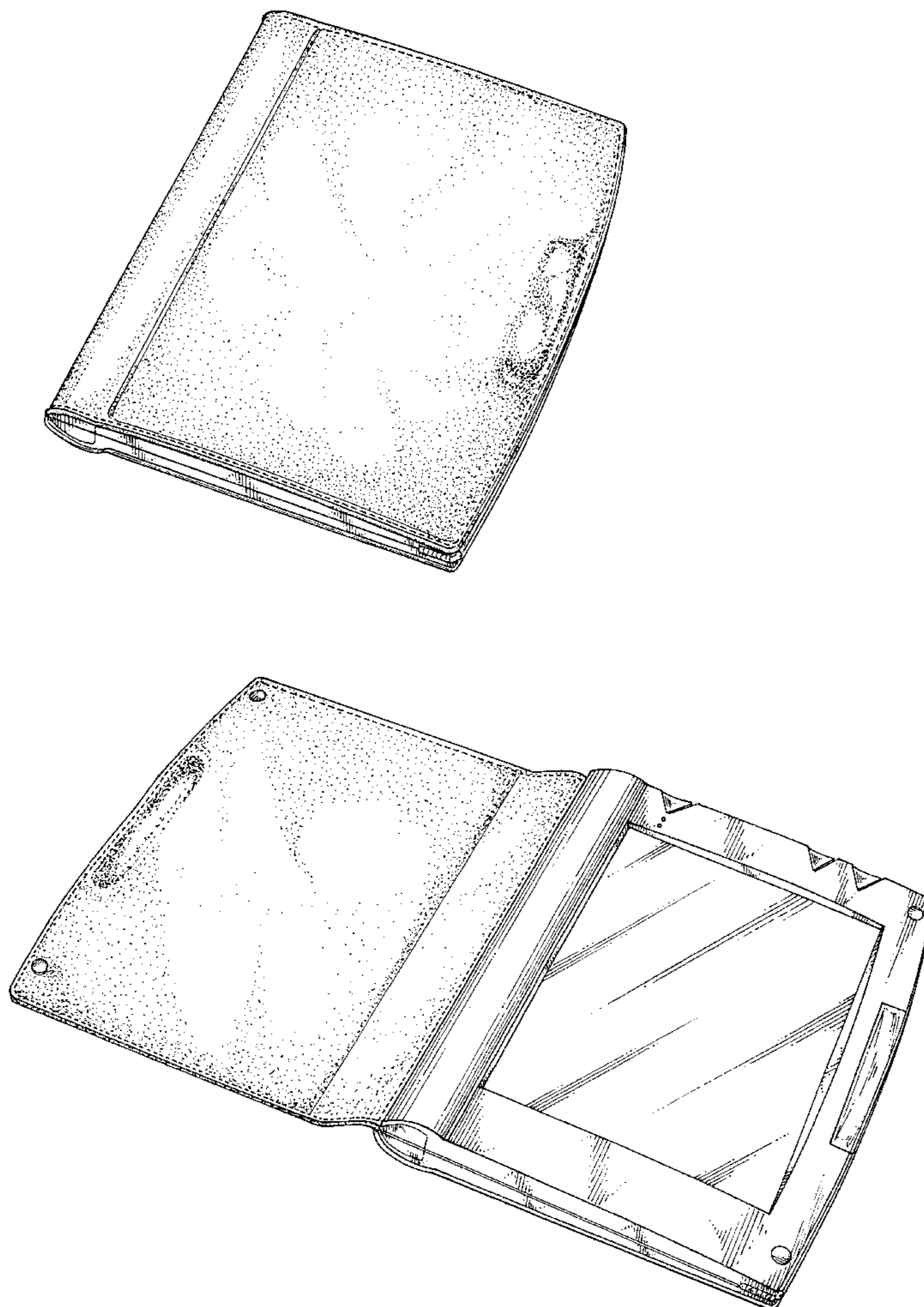

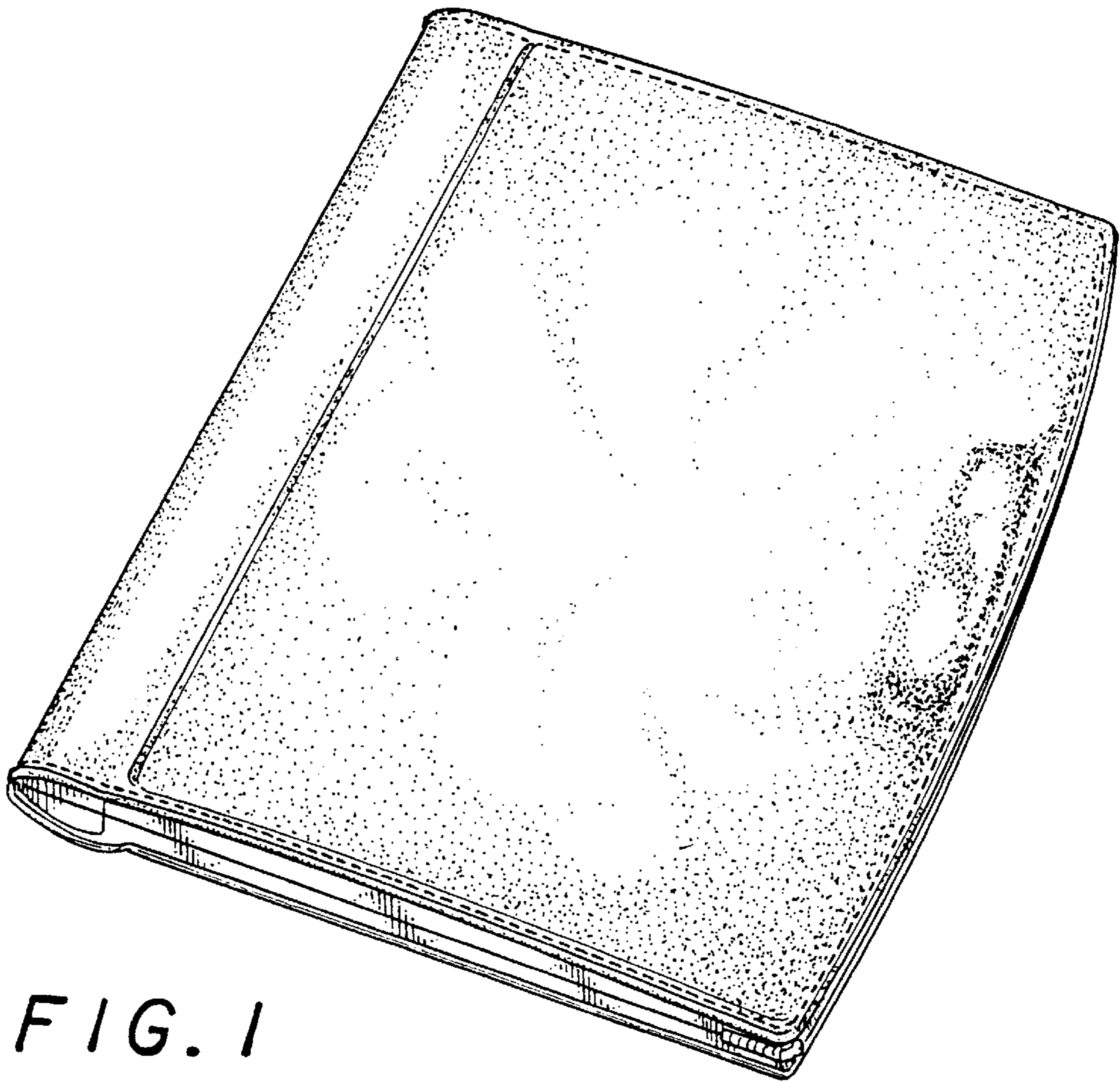

FIG. 1

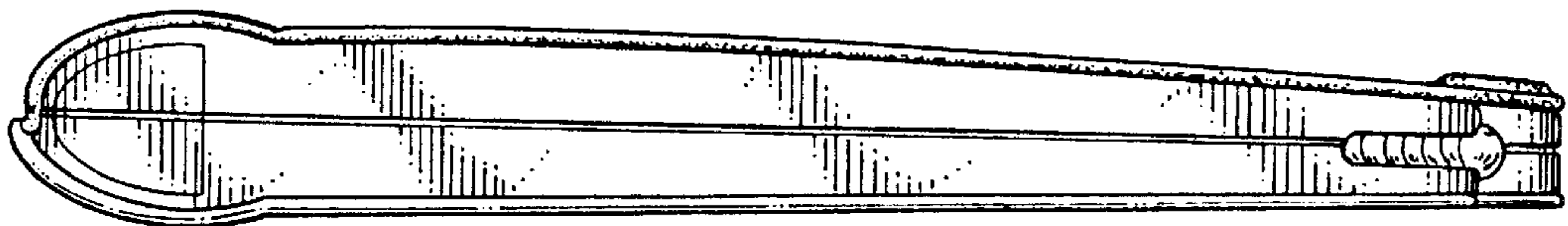

FIG. 2

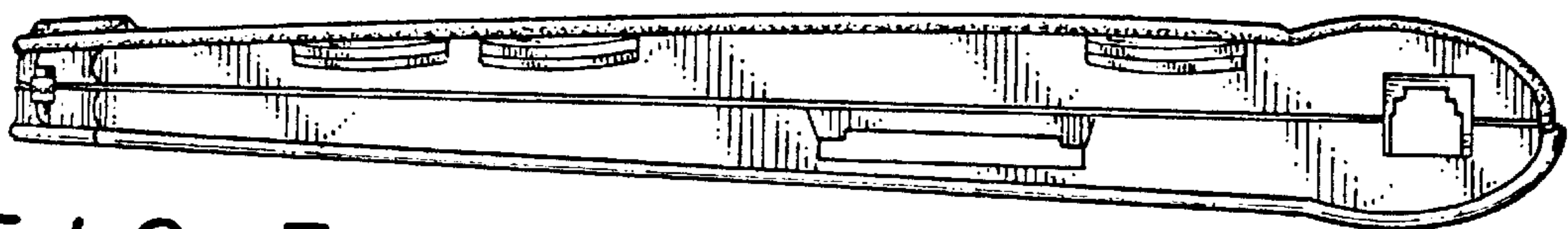

FIG. 3

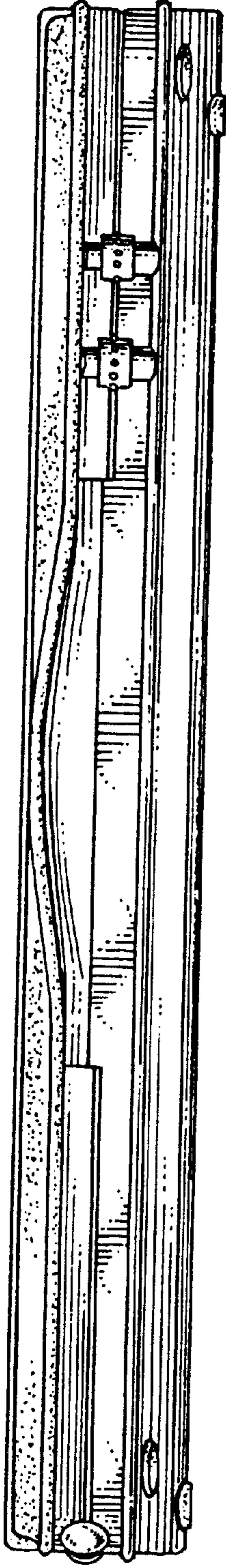

FIG. 4

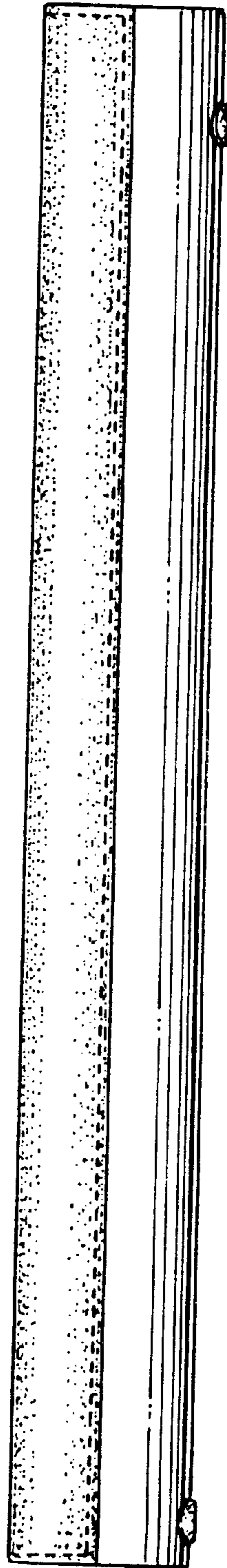

FIG. 5

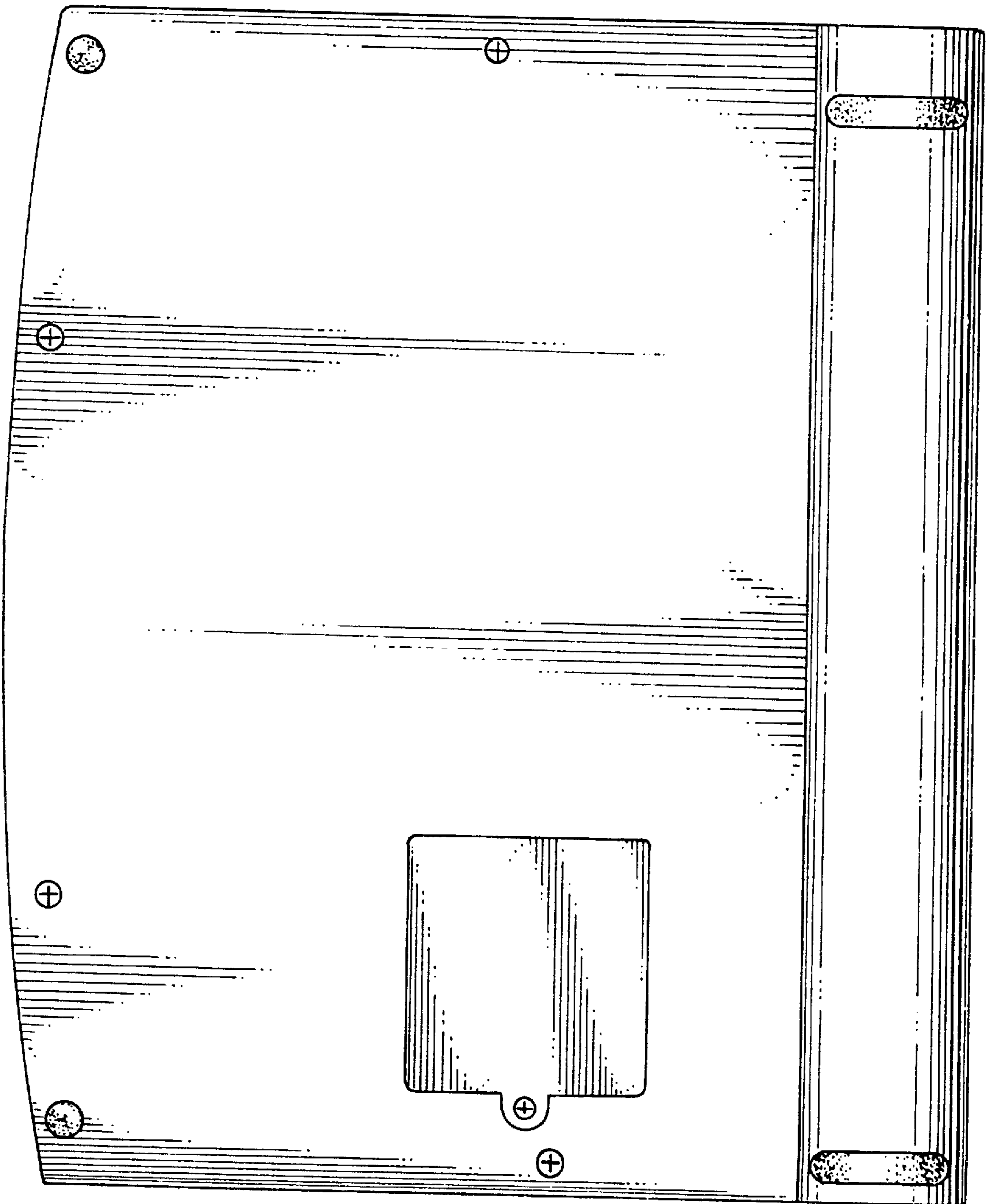

FIG. 6

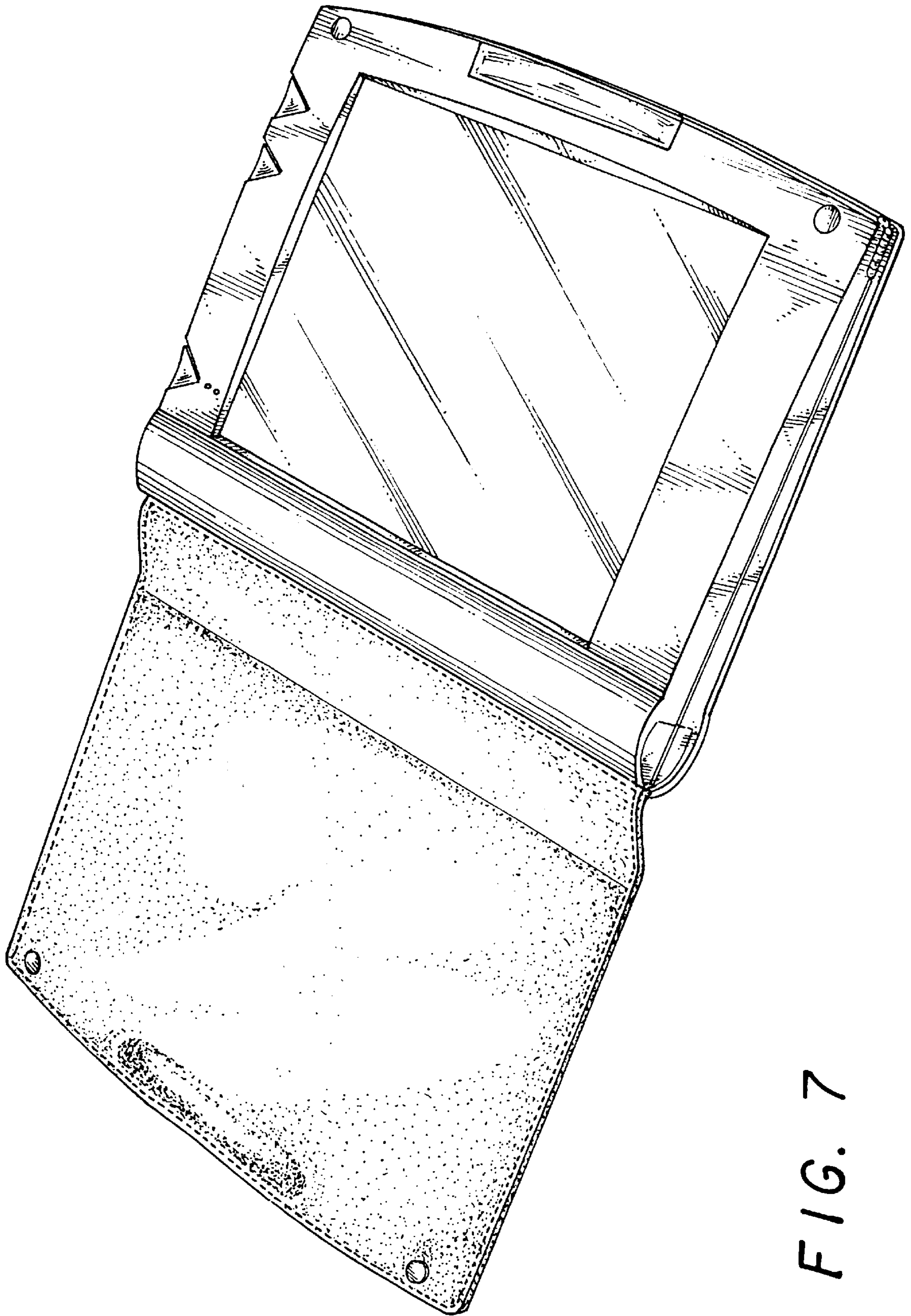

FIG. 7

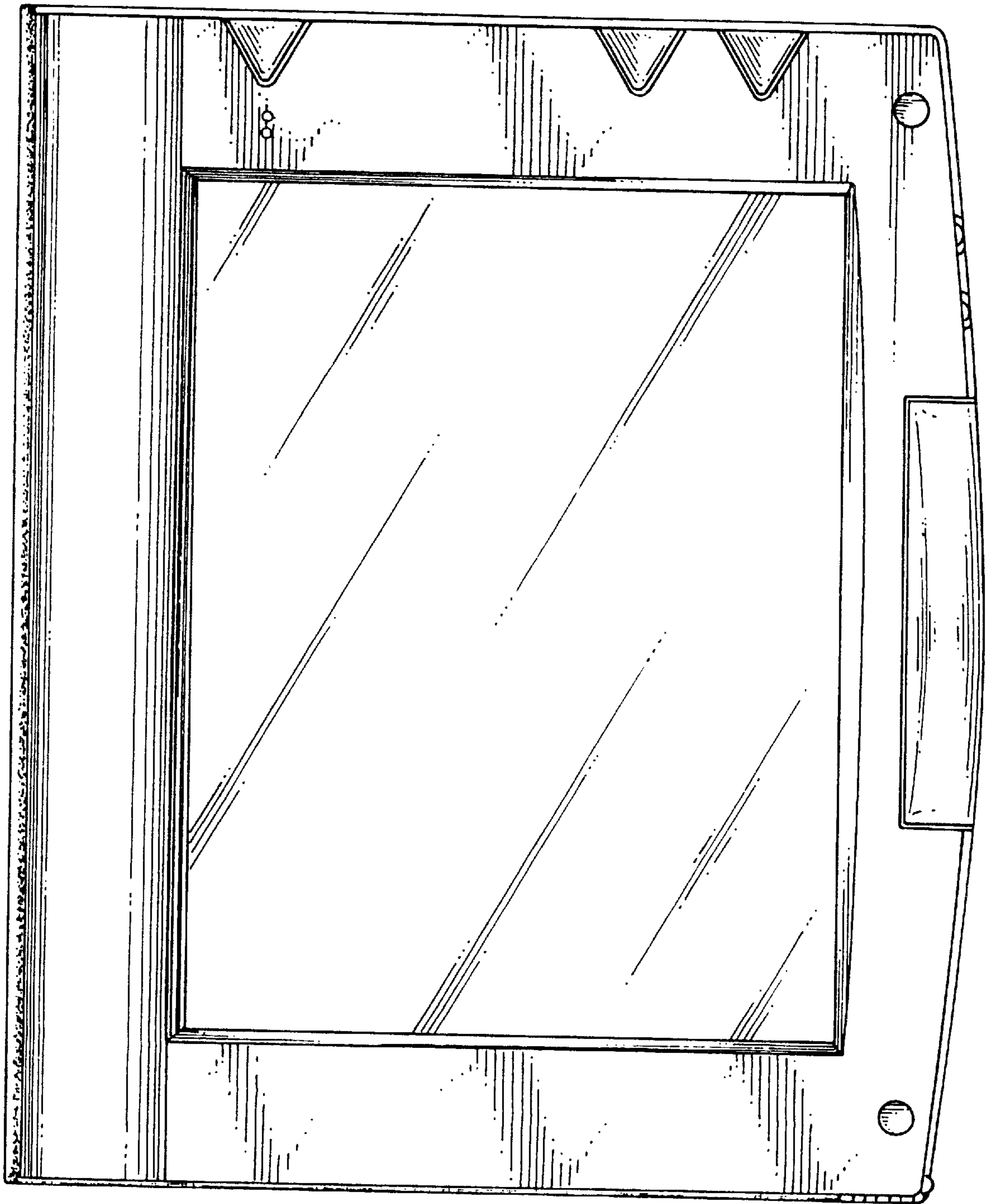

FIG. 8

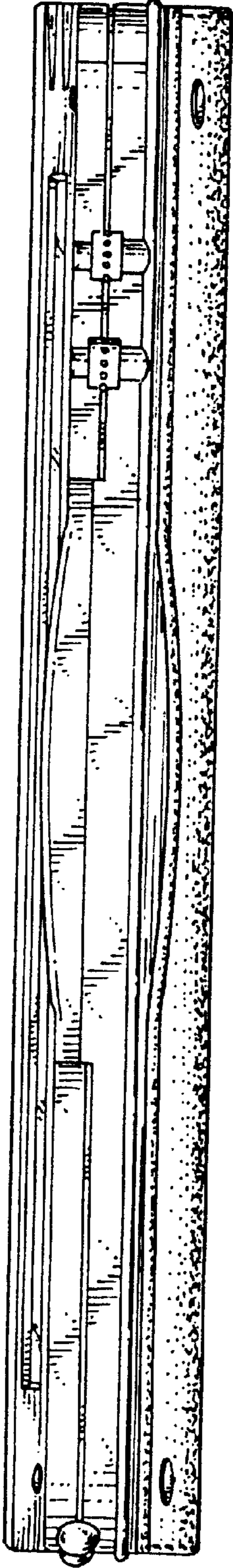

FIG. 9

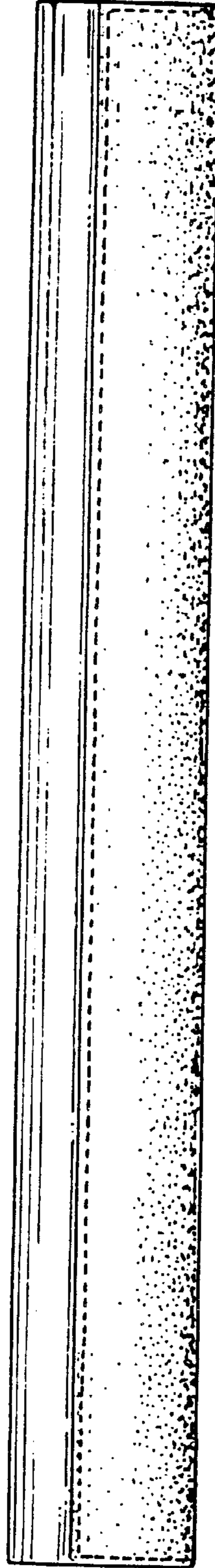

FIG. 10

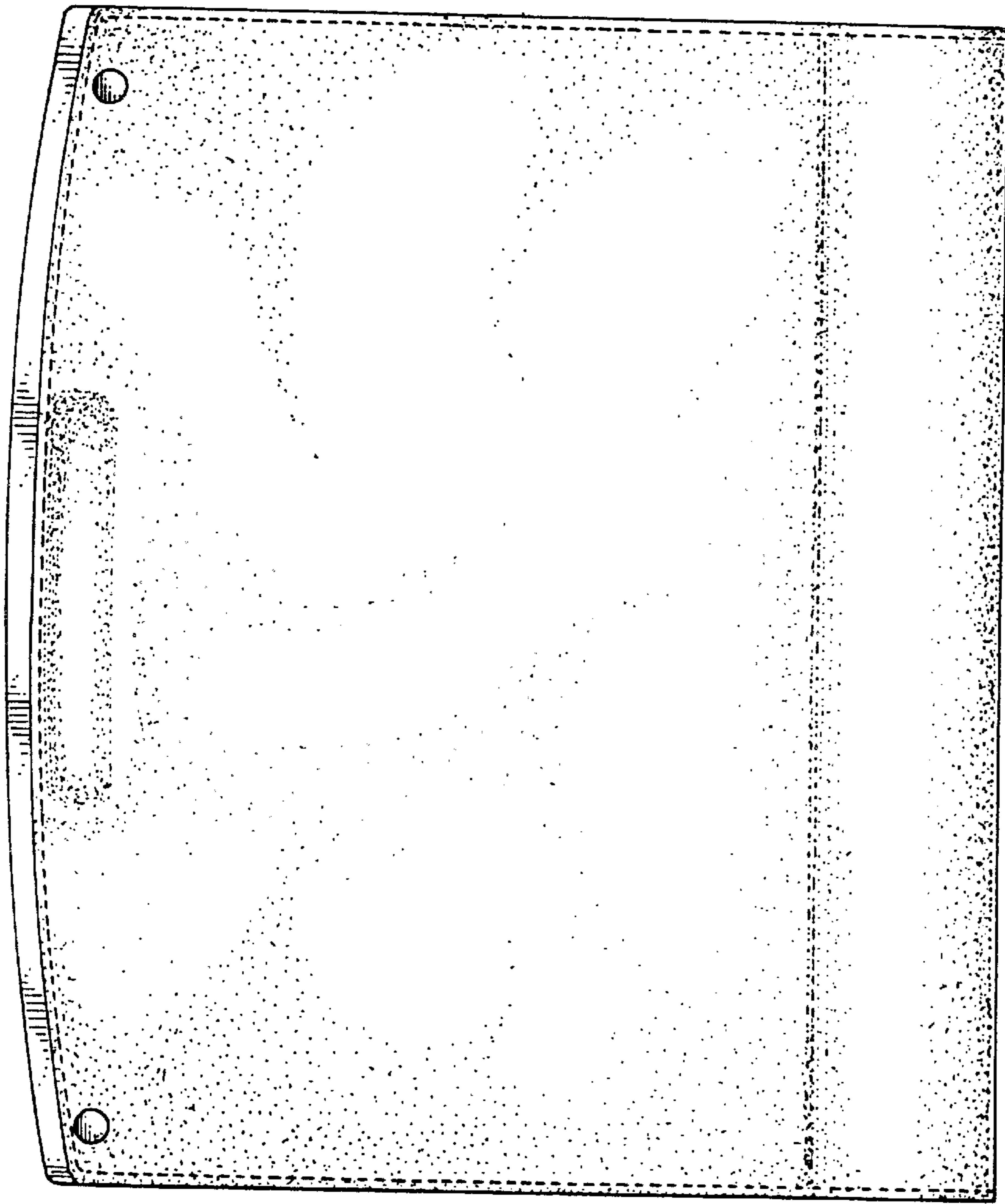

FIG. 11

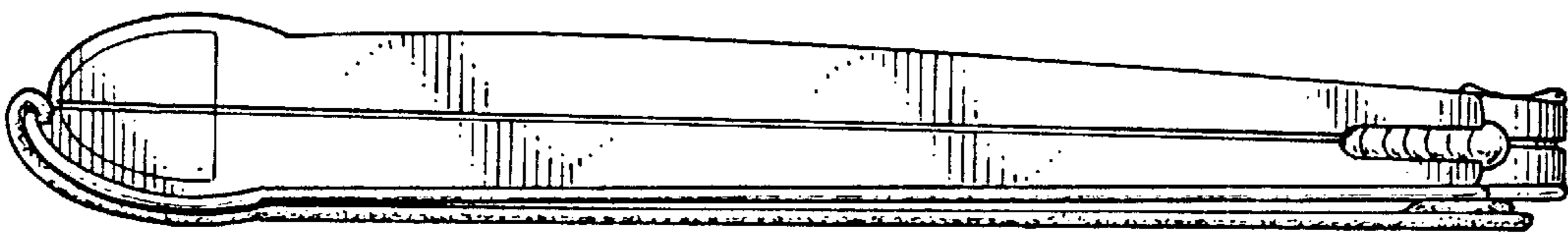

FIG. 12

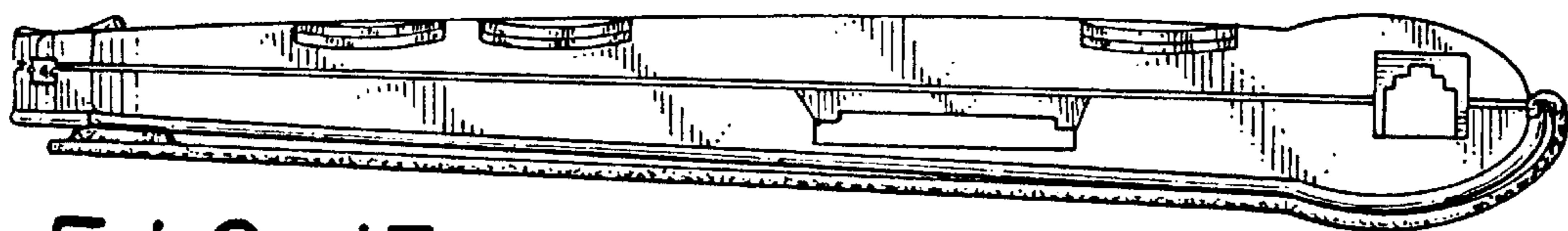

FIG. 13