



US00D430027S

United States Patent [19] Koock

[11] Patent Number: Des. 430,027

[45] Date of Patent: ** Aug. 29, 2000

[54] PACKAGE FOR NATURAL FIBER

[76] Inventor: James Timothy Koock, P.O. Box One, Fredricksburg, Tex. 78624

[**] Term: 14 Years

[21] Appl. No.: 29/097,883

[22] Filed: Dec. 16, 1998

[51] LOC (7) Cl. 09-03

[52] U.S. Cl. D9/432; D9/418

[58] Field of Search D9/345-346, 414, D9/430-433, 418; 206/83.5

[56] References Cited

U.S. PATENT DOCUMENTS

152,560	6/1874	King	206/83.5
443,619	12/1890	Orr	206/83.5
443,620	12/1890	Orr	206/83.5
496,042	4/1893	Dederick	206/83.5
1,574,885	3/1926	Henne	206/83.5
1,726,523	9/1929	Blows	206/83.5
2,971,643	2/1961	Farley	206/83.5
3,906,591	9/1975	Boiardi	206/83.5
4,538,385	9/1985	Kandarian	52/3
4,746,011	5/1988	McNair, Jr. et al.	206/83.5
5,035,323	7/1991	Daniels et al.	206/459.5
5,632,558	5/1997	Baker	383/75

FOREIGN PATENT DOCUMENTS

0012269	7/1933	Australia	206/83.5
0563497	6/1960	Belgium	150/154
0843259	6/1970	Canada	206/83.5
0149491	7/1981	Germany	383/99
1266390	3/1972	United Kingdom	383/99

OTHER PUBLICATIONS

Texas A&M Research & Extension Center photographs, taken Jul. 22, 1998; the prior art indicated in photographs 2 and 3 was in general use in wool industry prior to Dec. 16, 1997.

Primary Examiner—Ted Shooman

Assistant Examiner—Carol Rademaker

Attorney, Agent, or Firm—Fulbright & Jaworski L.L.P.

[57] CLAIM

The ornamental design for a package for natural fiber, as shown and described.

DESCRIPTION

FIG. 1 is a front isometric view showing the front, top, and left side of my design for a package for natural fiber; FIG. 2 is a front elevation view thereof, the opposite side (i.e., rear side) being a mirror image of the front side shown; FIG. 3 is a left side elevation view thereof, the opposite side (i.e., right side) being a mirror image of the left side shown; FIG. 4 is a top plan view thereof; FIG. 5 is a bottom plan view thereof; FIG. 6 is an enlarged fragmentary view taken in the circled area FIG. 6 of FIG. 1 showing a pattern of apertures, it being understood that this pattern is repeated uniformly throughout the package design; and, FIG. 7 is a front isometric view of an alternative embodiment showing the front, top, and left side of my design for a package for natural fiber, it being understood that the rear and right sides are mirror images of the front and left sides, respectively. It is further understood that the bottom of the alternative embodiment of FIG. 7 is substantially the same as shown in FIG. 5, except that it is transparent in the alternative embodiment of FIG. 7.

1 Claim, 2 Drawing Sheets

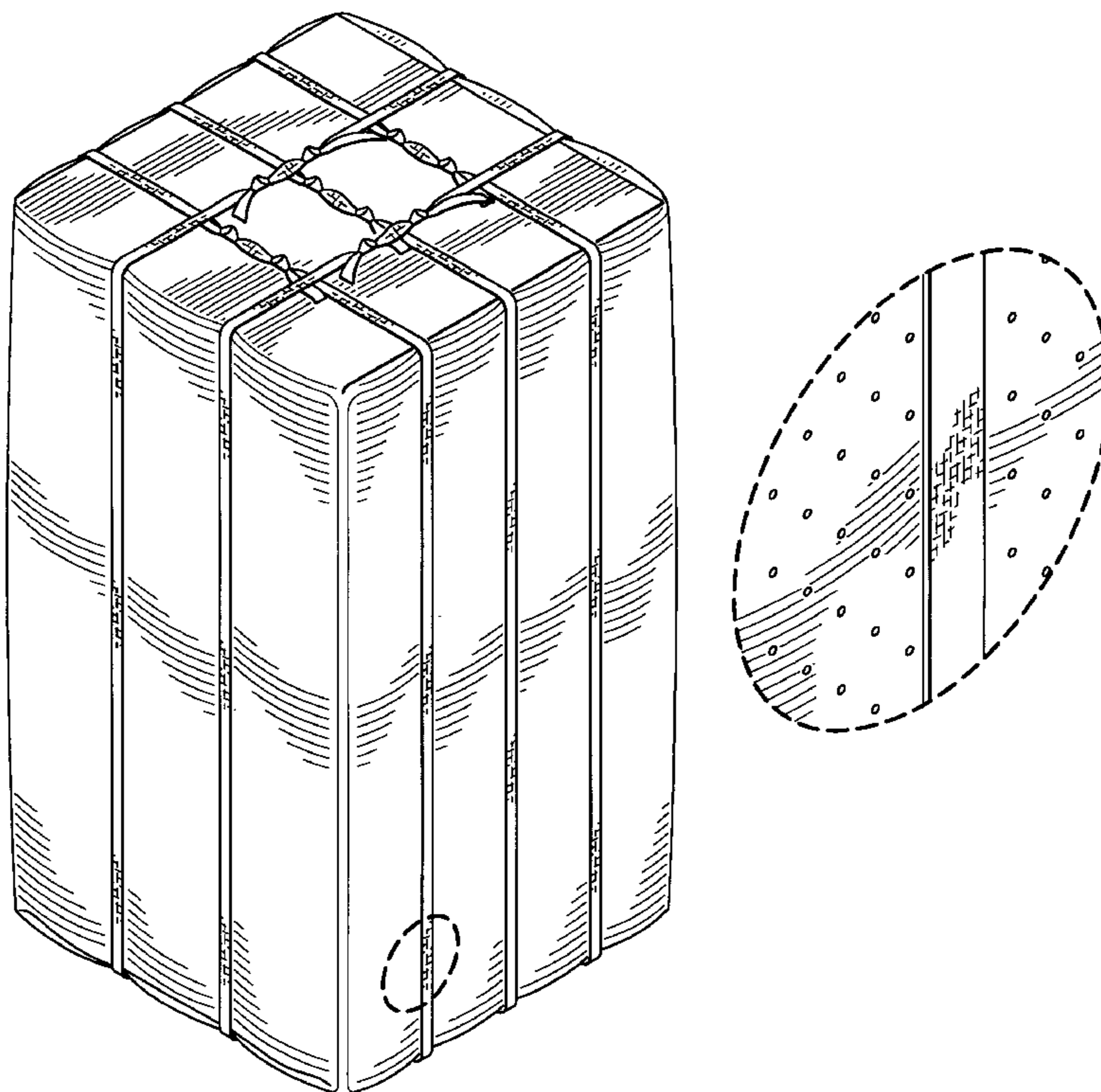

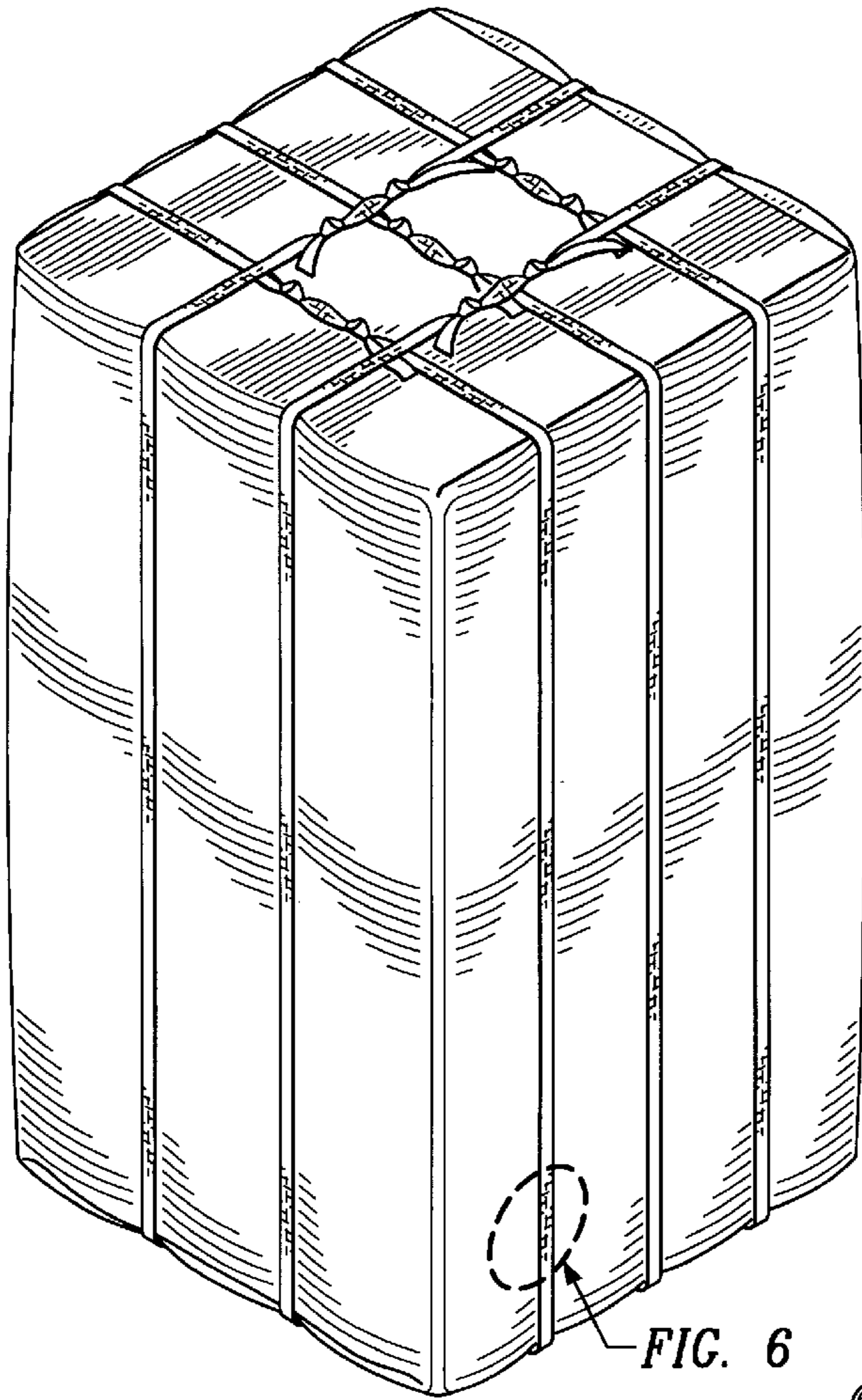

FIG. 1

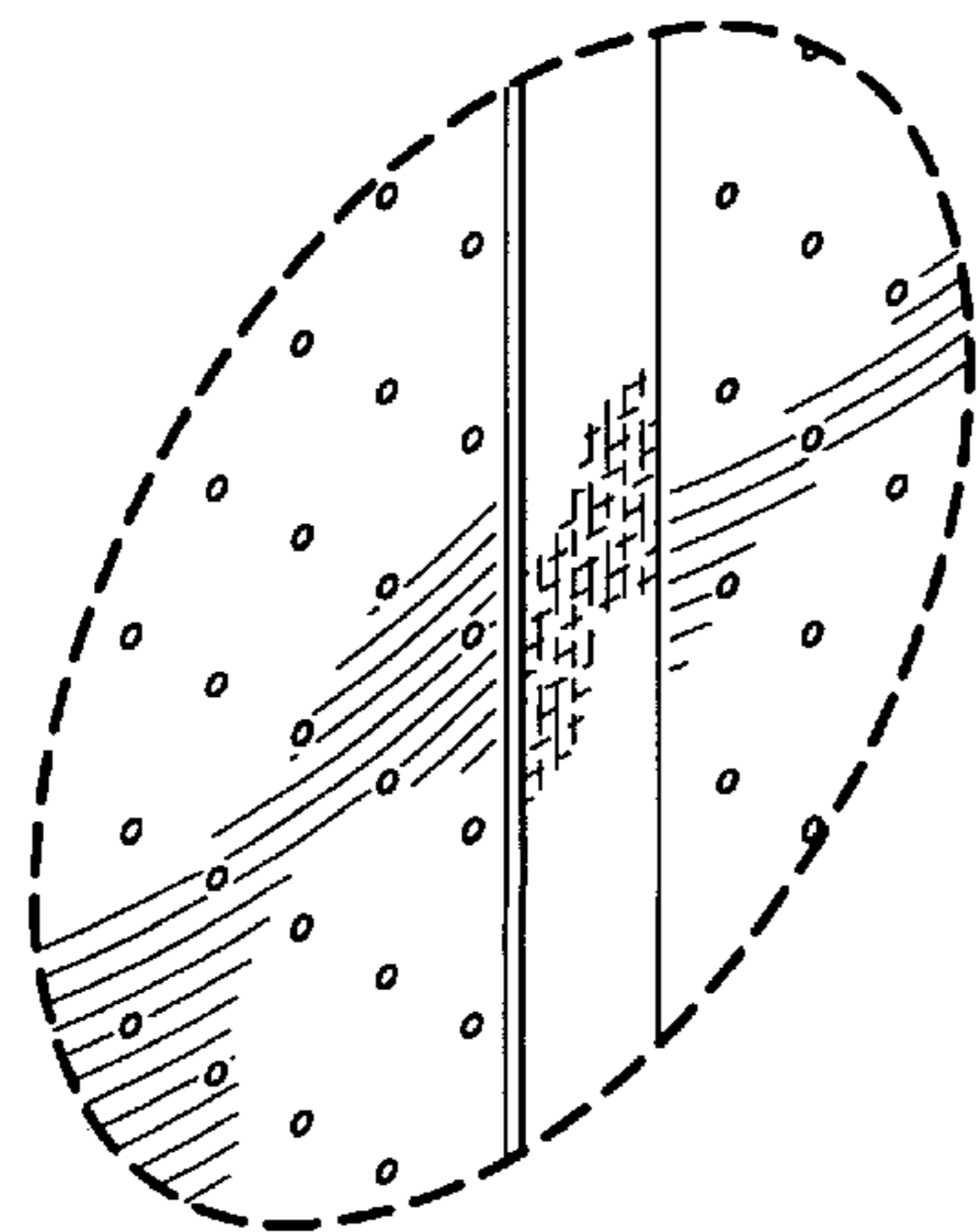

FIG. 6

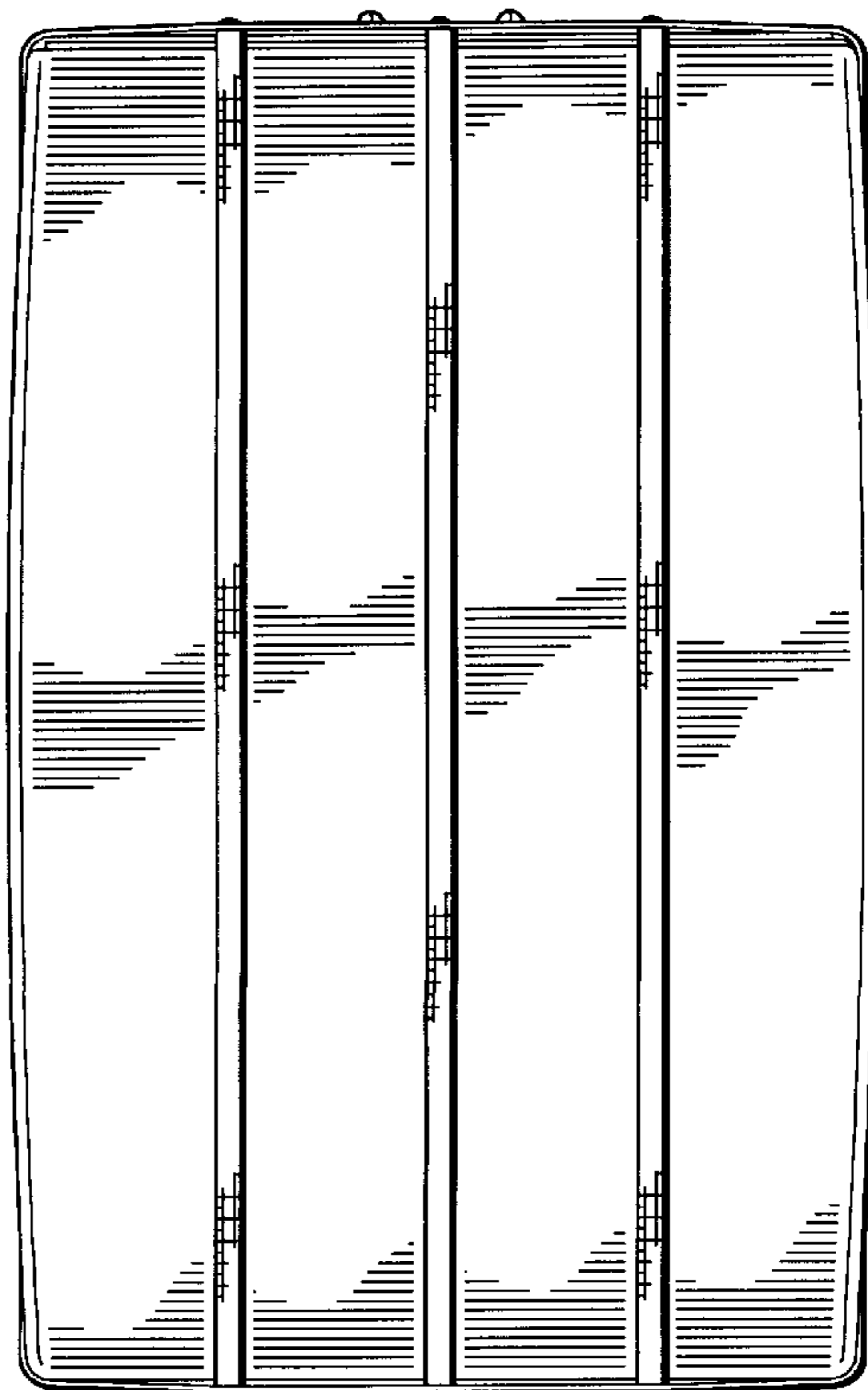

FIG. 2

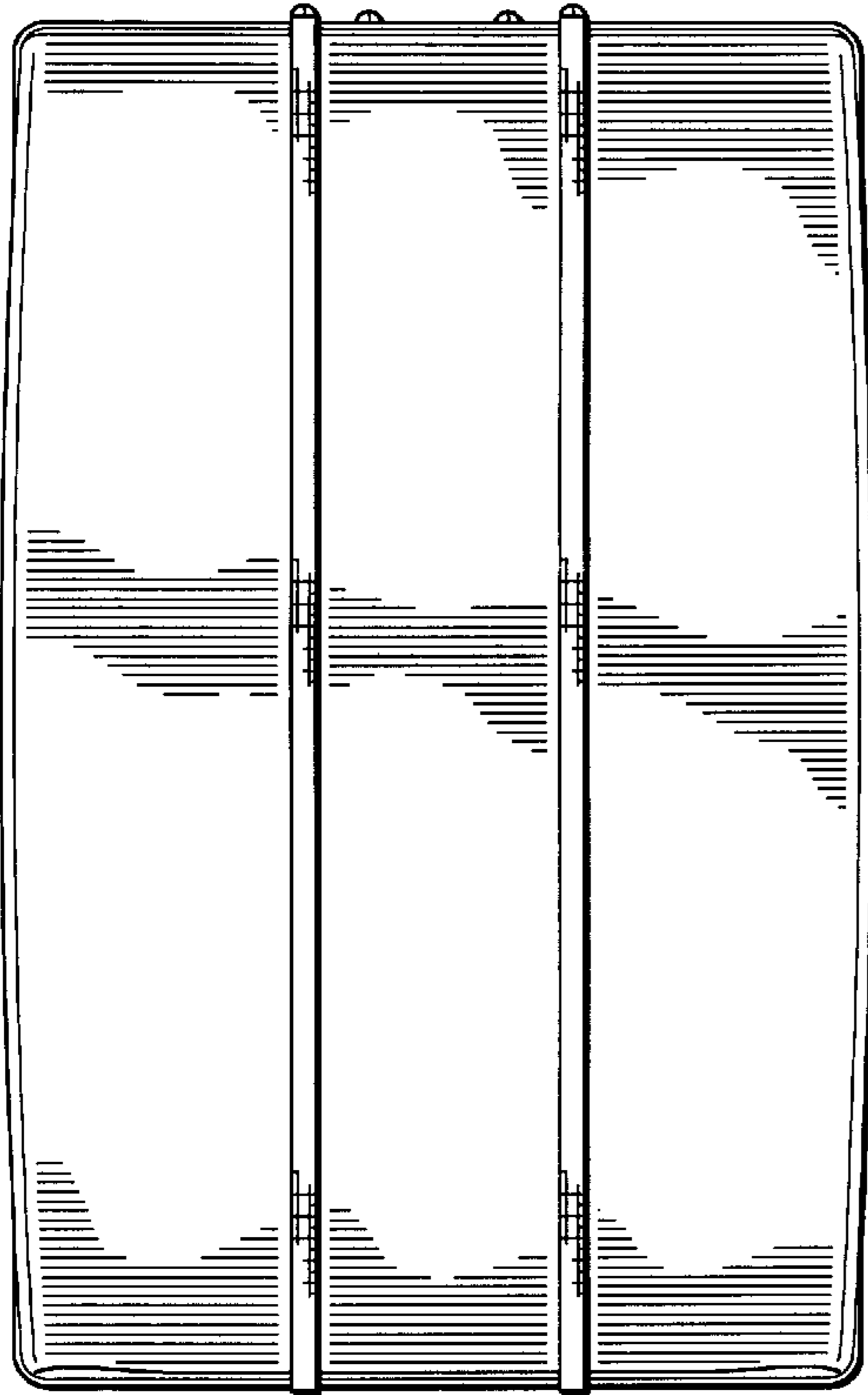

FIG. 3

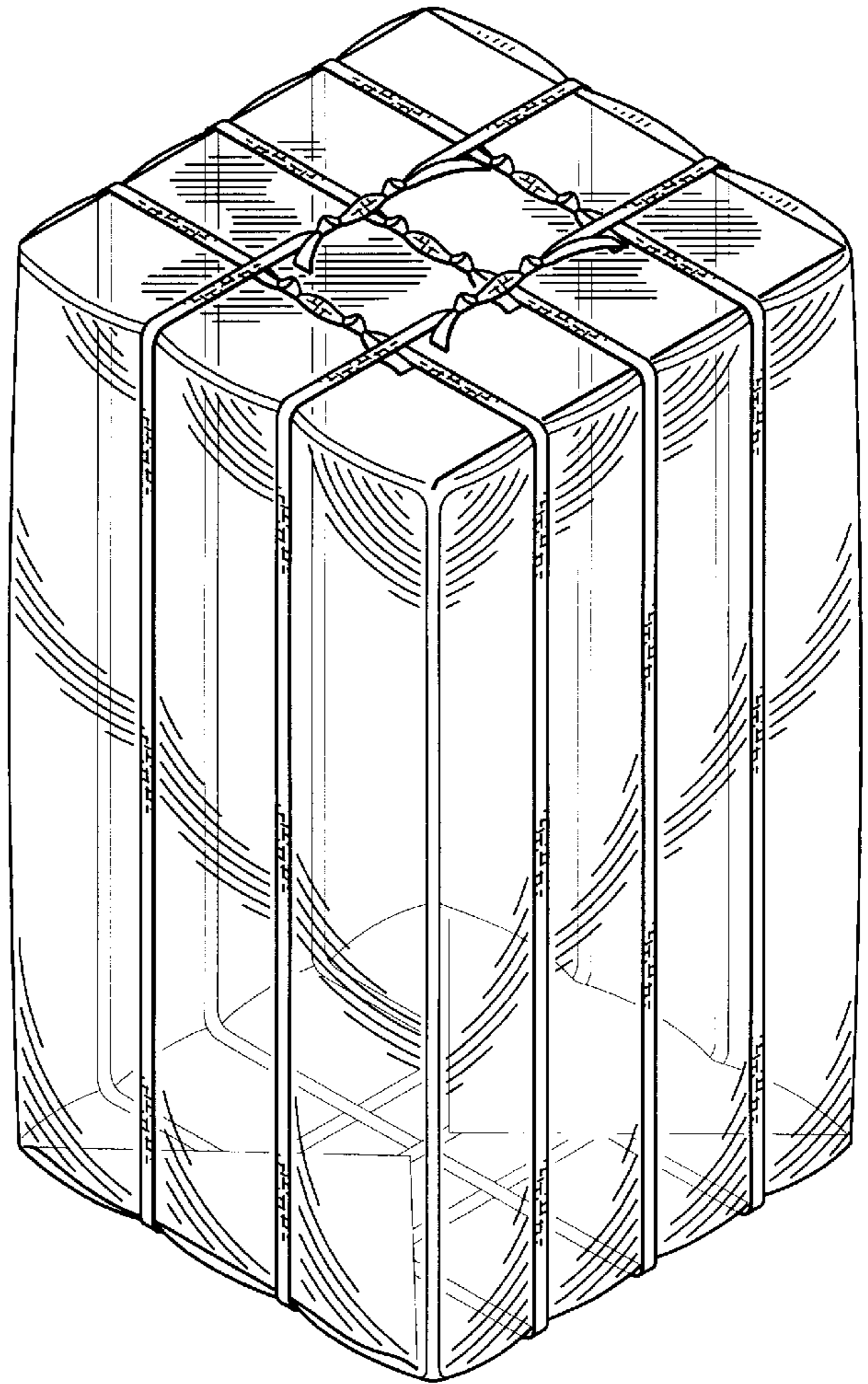

FIG. 7

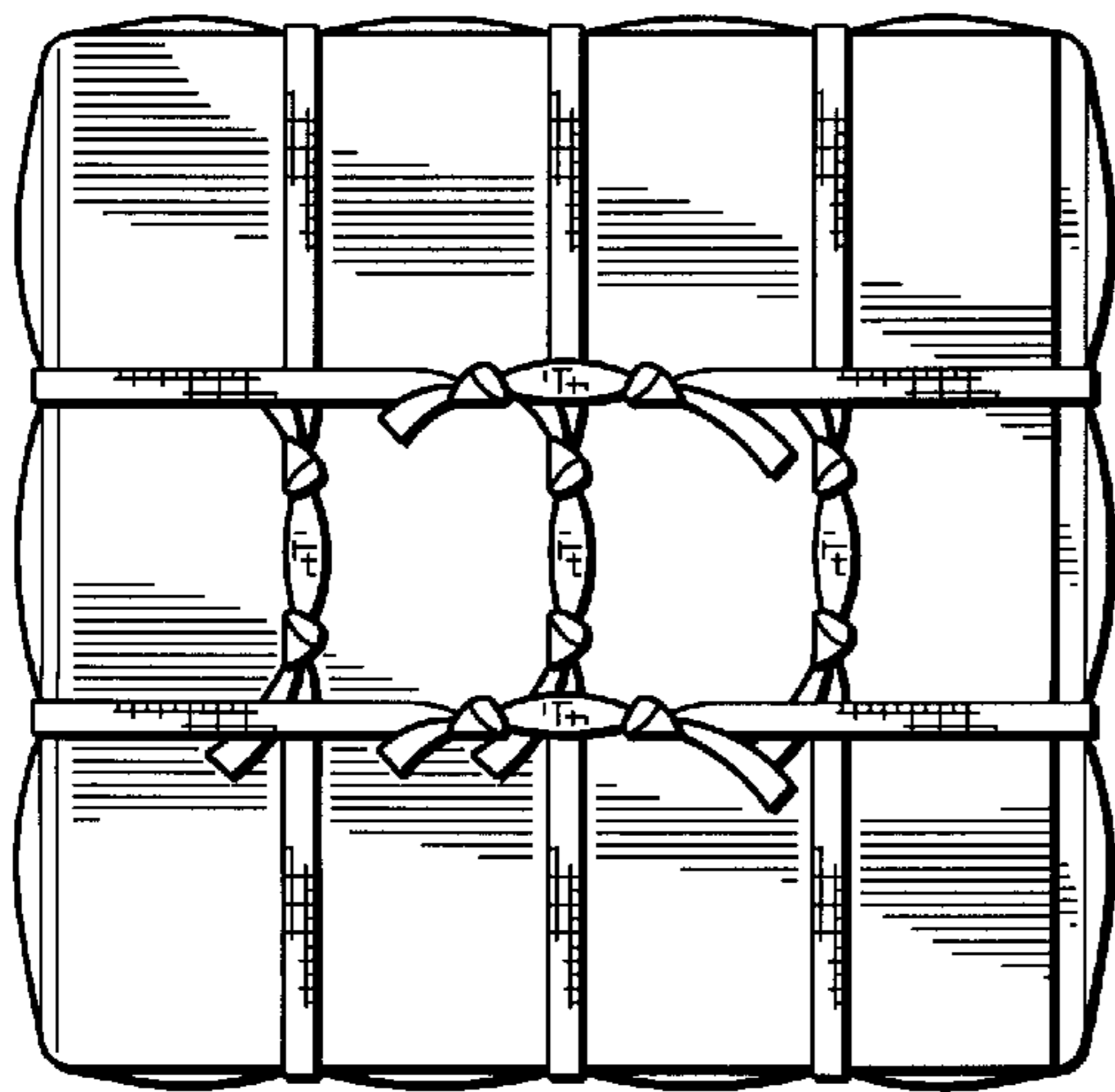

FIG. 4

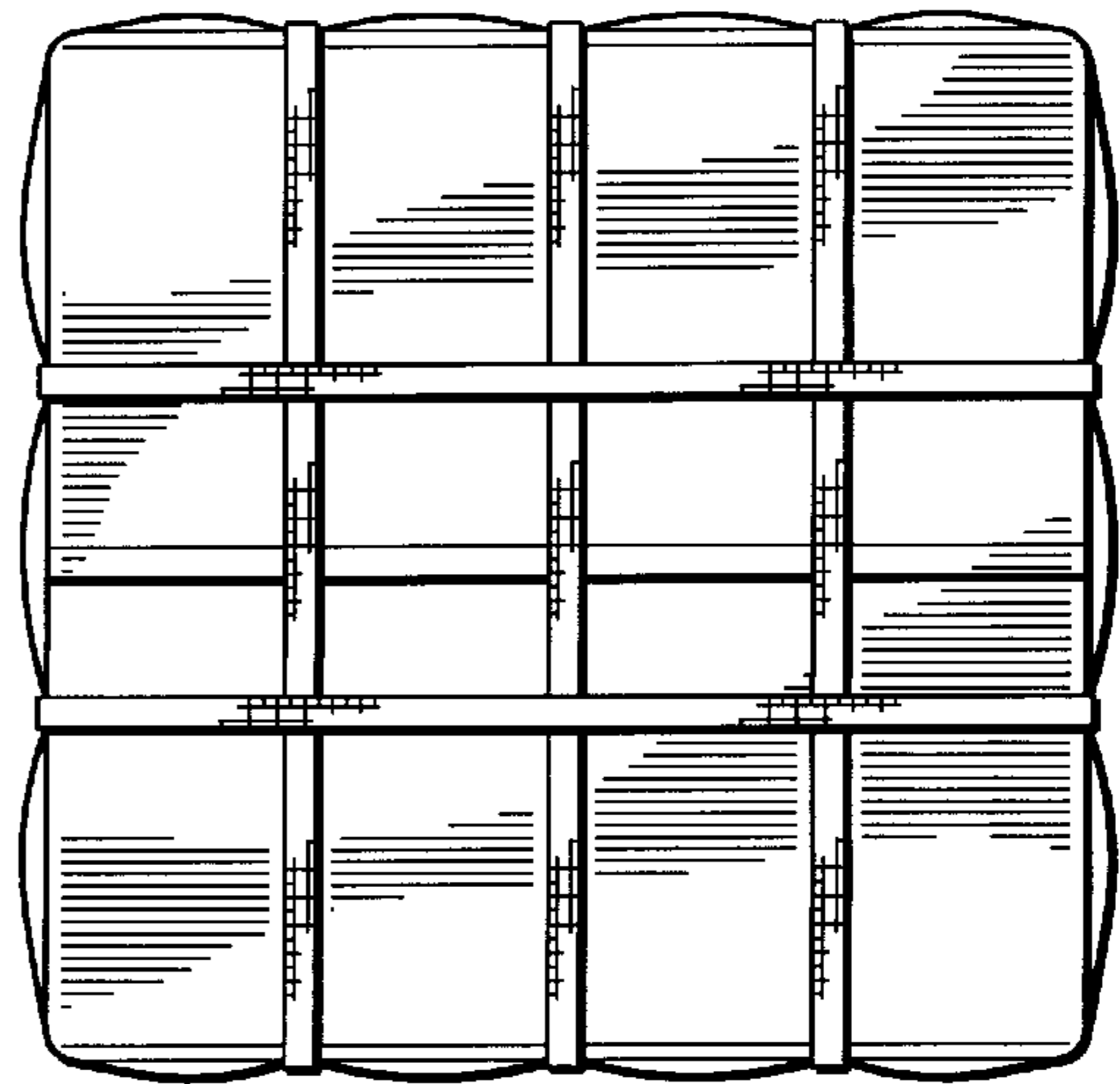

FIG. 5