



US00D430017S

# United States Patent [19]

Ito et al.

[11] Patent Number: **Des. 430,017**

[45] Date of Patent: **\*\* Aug. 29, 2000**

## [54] CASE

[75] Inventors: **Masahiko Ito; Hisashi Nakano**, both of Tokyo, Japan

[73] Assignee: **Sony Corporation**, Japan

[\*\*] Term: **14 Years**

[21] Appl. No.: **29/107,310**

[22] Filed: **Jul. 6, 1999**

## [30] Foreign Application Priority Data

Jan. 28, 1999 [JP] Japan ..... 11-1675

[51] **LOC (7) Cl.** ..... **09-07**

[52] **U.S. Cl.** ..... **D9/415**

[58] **Field of Search** ..... D9/415, 418, 414, D9/337, 332; 206/461-471, 806, 495, 769-773, 775-783, 703, 704, 708

## [56] References Cited

### U.S. PATENT DOCUMENTS

D. 268,251	3/1983	Savage	.....	D9/415	X
D. 319,185	8/1991	Ferrero	.....	D9/415	
D. 327,426	6/1992	Karita et al.	.....	D9/415	
D. 369,547	5/1996	Dahlheimer	.....	D9/415	
D. 405,369	2/1999	Dohner	.....	D9/415	
D. 406,754	3/1999	Tanabe	.....	D9/415	
3,904,029	9/1975	Koltz	.....	206/806	X
3,946,946	3/1976	Brown	.....	206/806	X
4,257,522	3/1981	Thorneburg	.....	206/806	X

## OTHER PUBLICATIONS

Techform Inc. (From 206/461 Shoe), Nov. 1982.  
Modern Packaging Catalog, p. 300, Jan. 1941.  
Catalog "90", pp. 300 & 301, Sony, (Nov. 1998).

*Primary Examiner*—Prabhakar Deshmukh  
*Attorney, Agent, or Firm*—Rader, Fishman & Grauer

## [57] CLAIM

The ornamental design for a case, as shown and described.

## DESCRIPTION

FIG. 1 is a perspective view of a first embodiment of a case showing our new design;  
FIG. 2 is a top plan view thereof;  
FIG. 3 is a left side elevational view thereof;  
FIG. 4 is a front elevational view thereof;  
FIG. 5 is a bottom plan view thereof;  
FIG. 6 is a right side elevational view thereof; and  
FIG. 7 is a rear elevational view thereof.  
FIG. 8 is a perspective view of a second embodiment of a case showing our new design;  
FIG. 9 is a top plan view thereof;  
FIG. 10 is a left side elevational view thereof;  
FIG. 11 is a front elevational view thereof;  
FIG. 12 is a bottom plan view thereof;  
FIG. 13 is a right side elevational view thereof; and,  
FIG. 14 is a rear elevational view thereof.

**1 Claim, 6 Drawing Sheets**

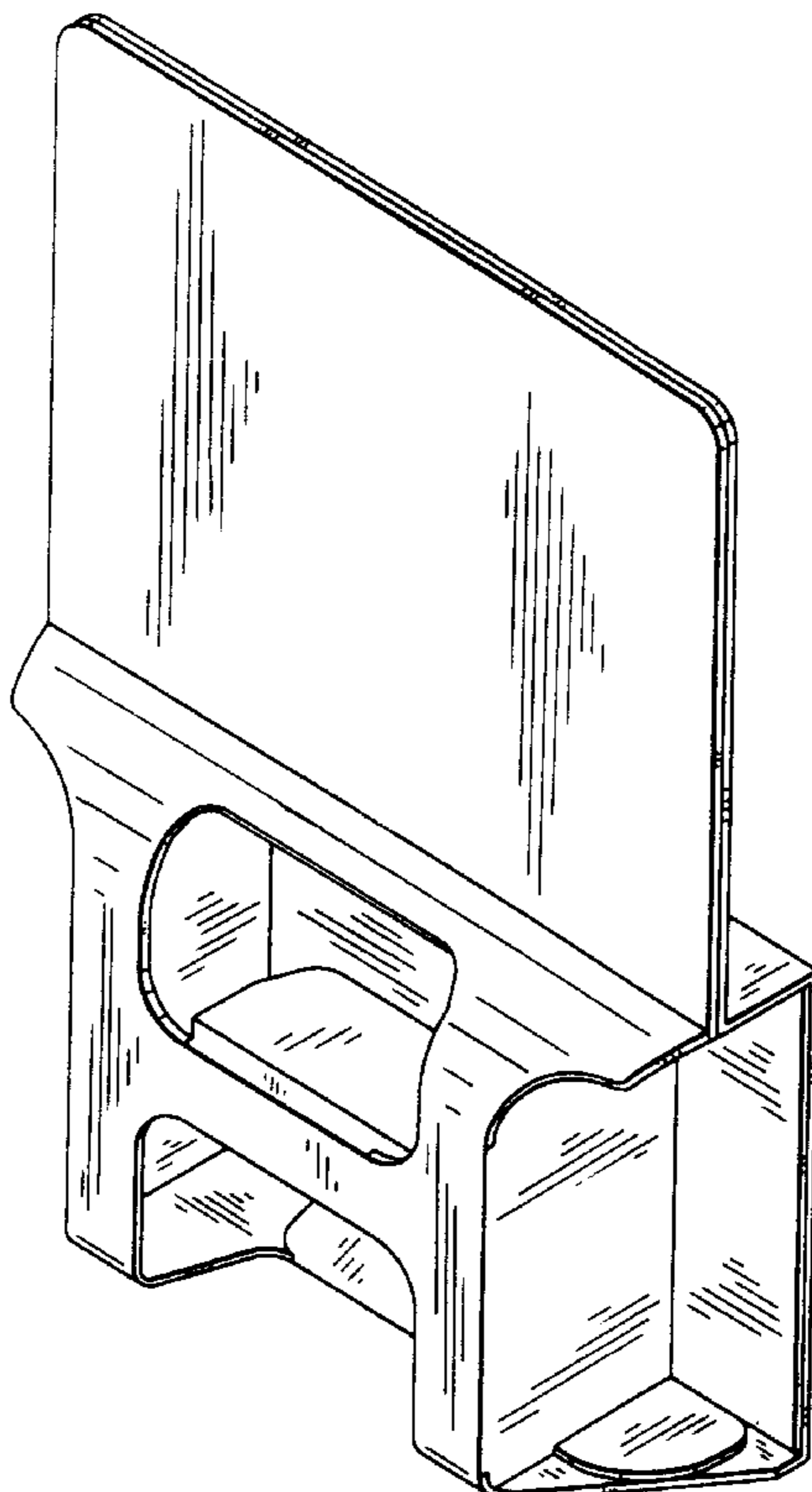

FIG. 1

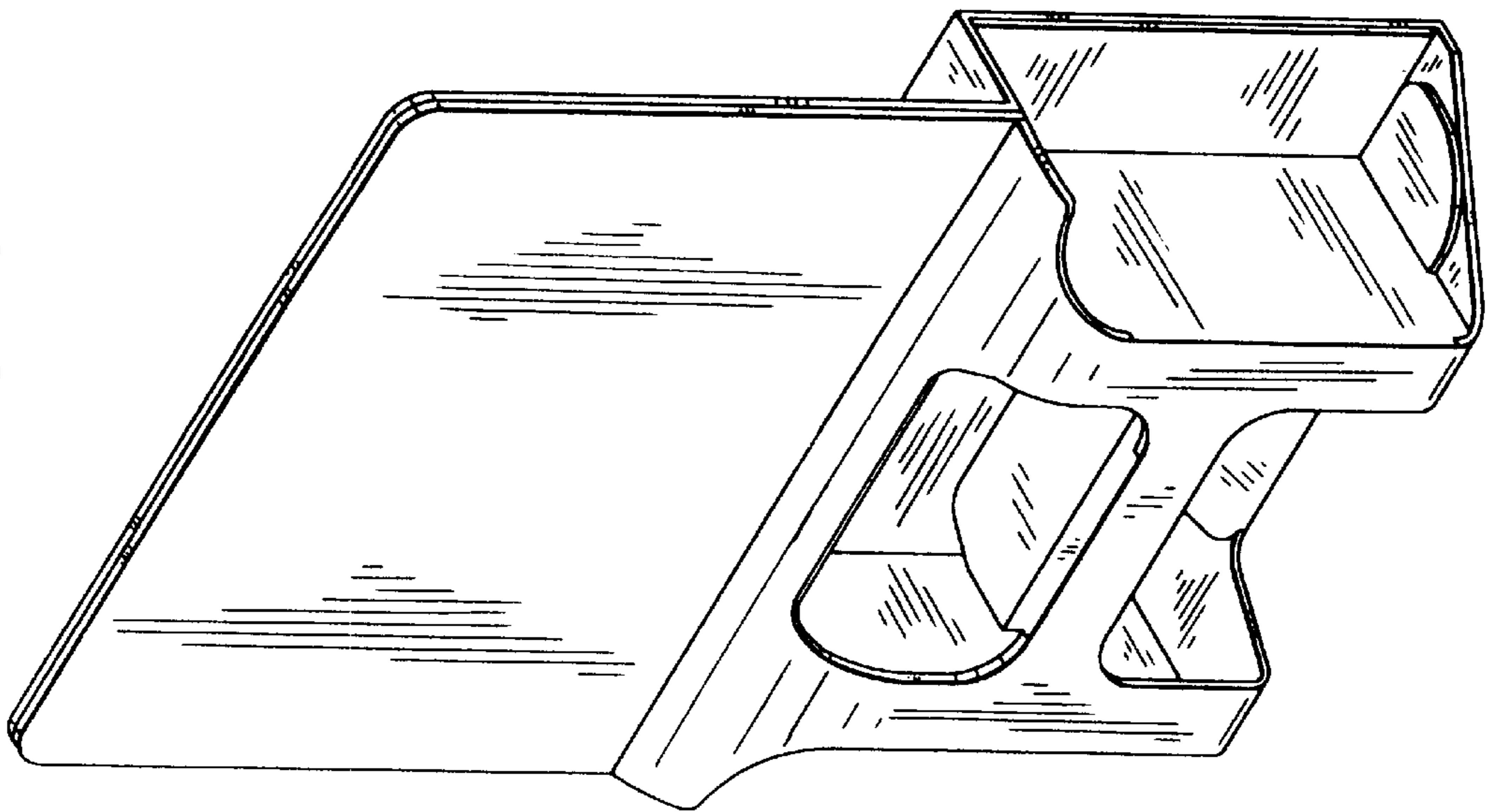

FIG. 4

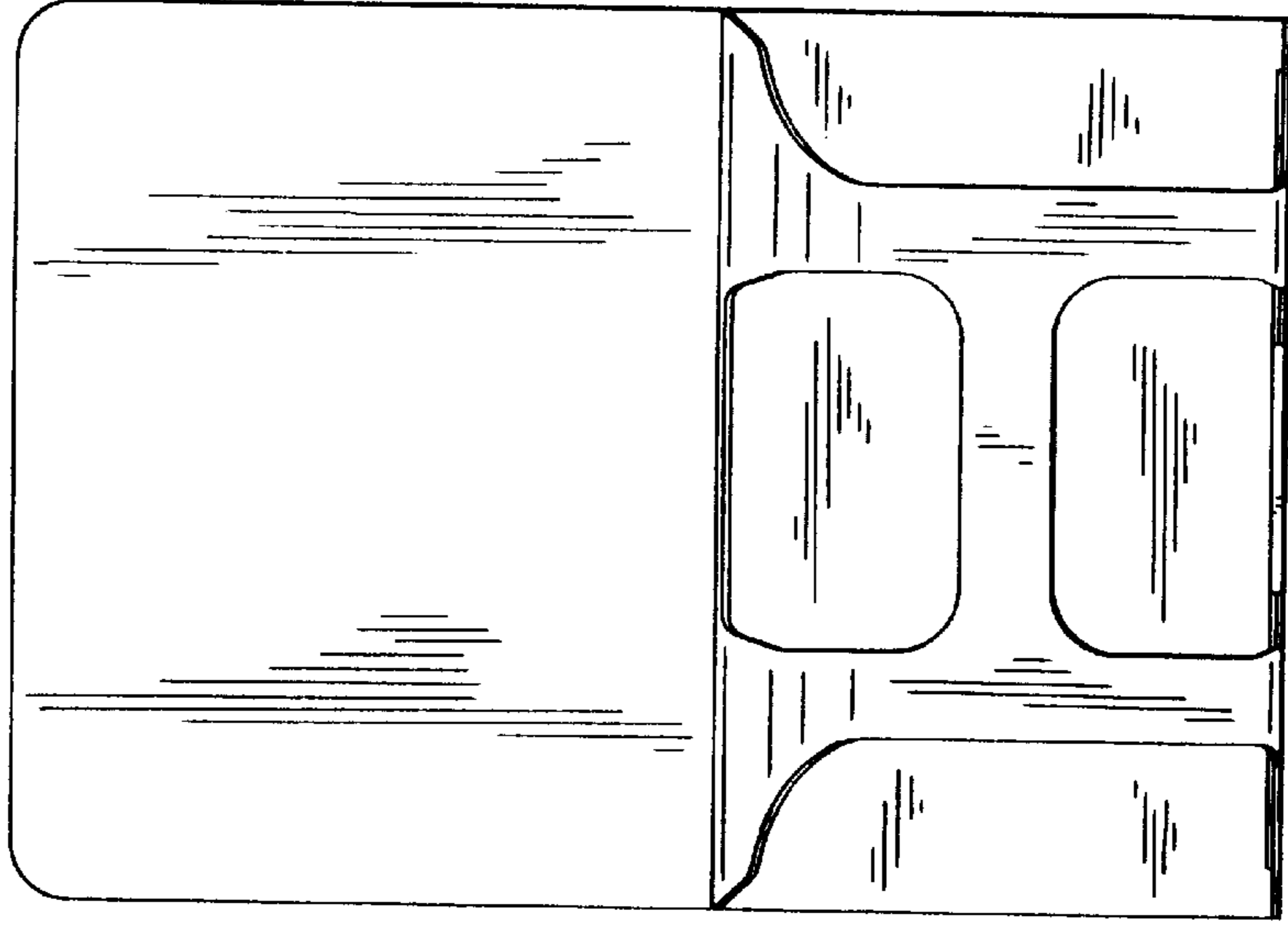

FIG. 3

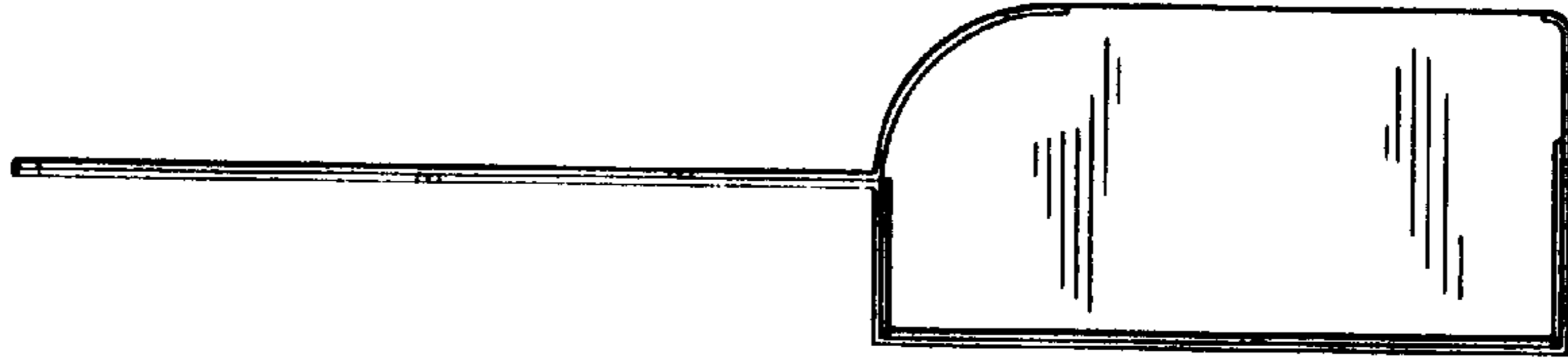

FIG. 2

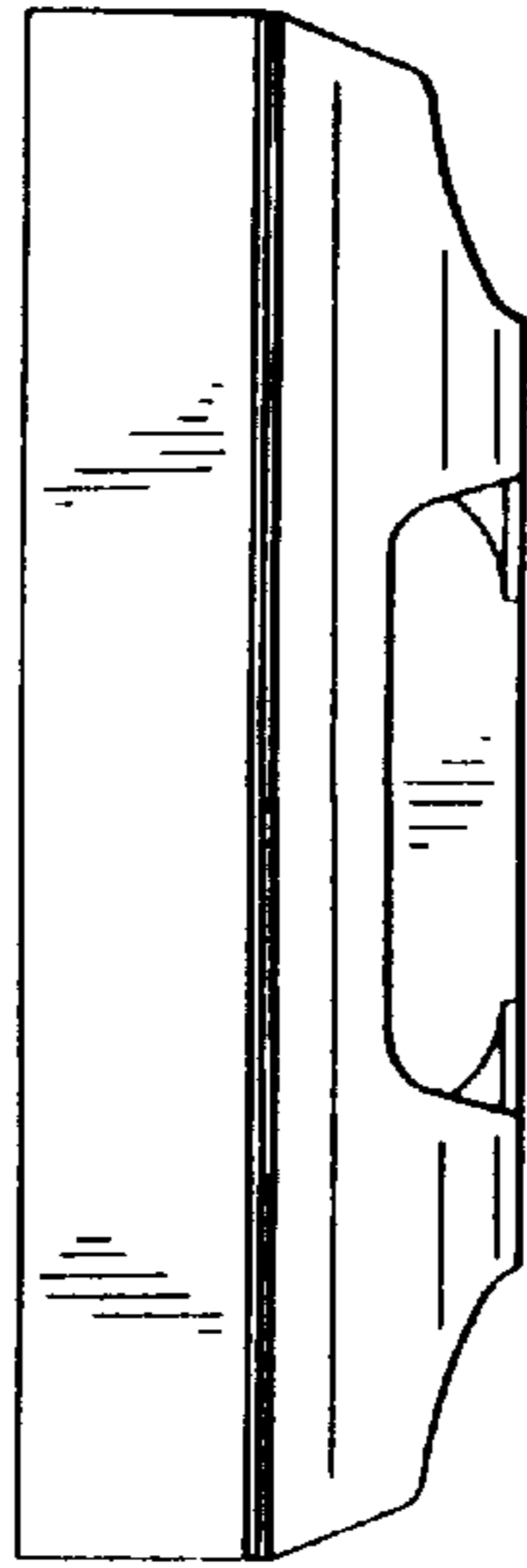

FIG. 7

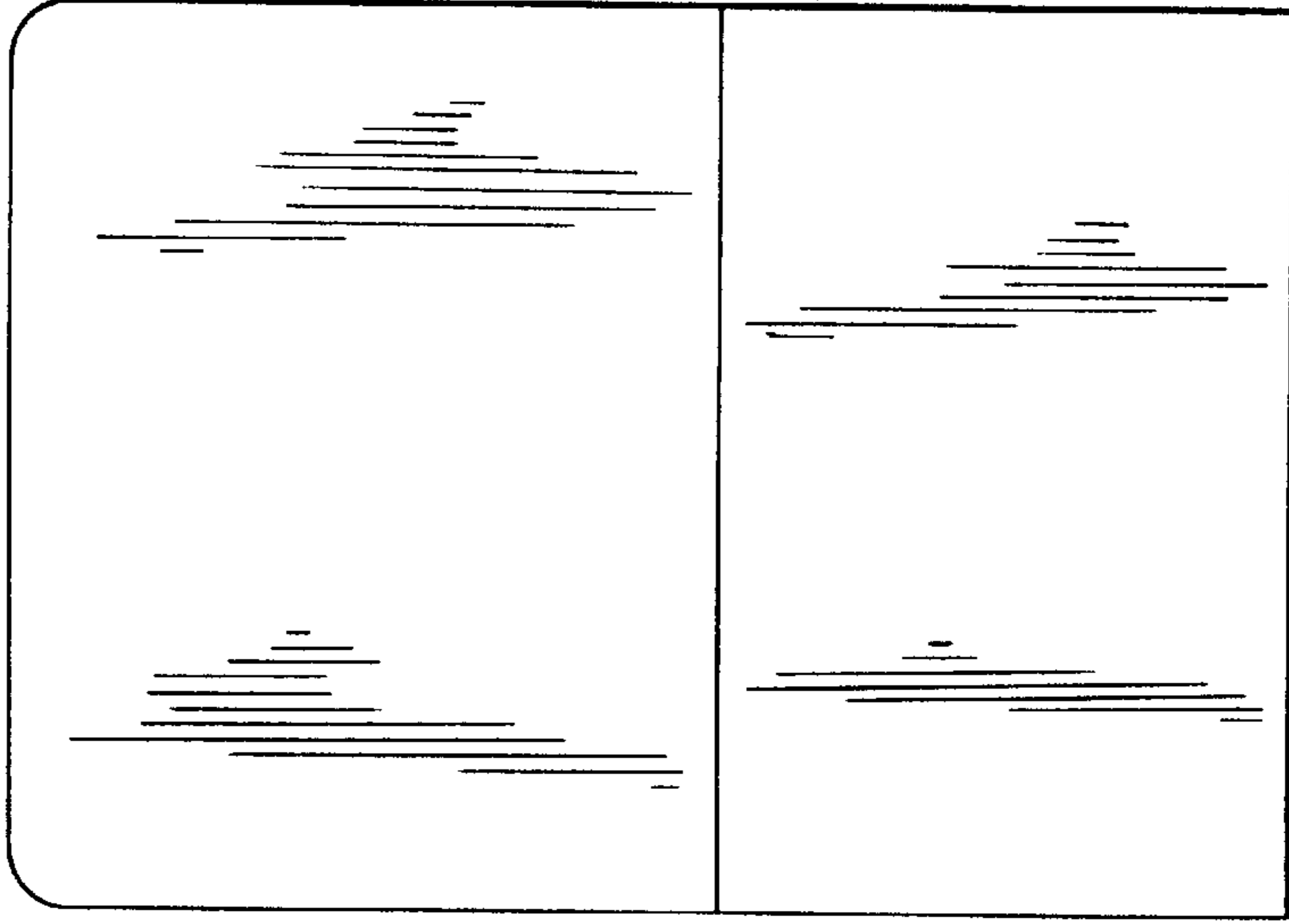

FIG. 6

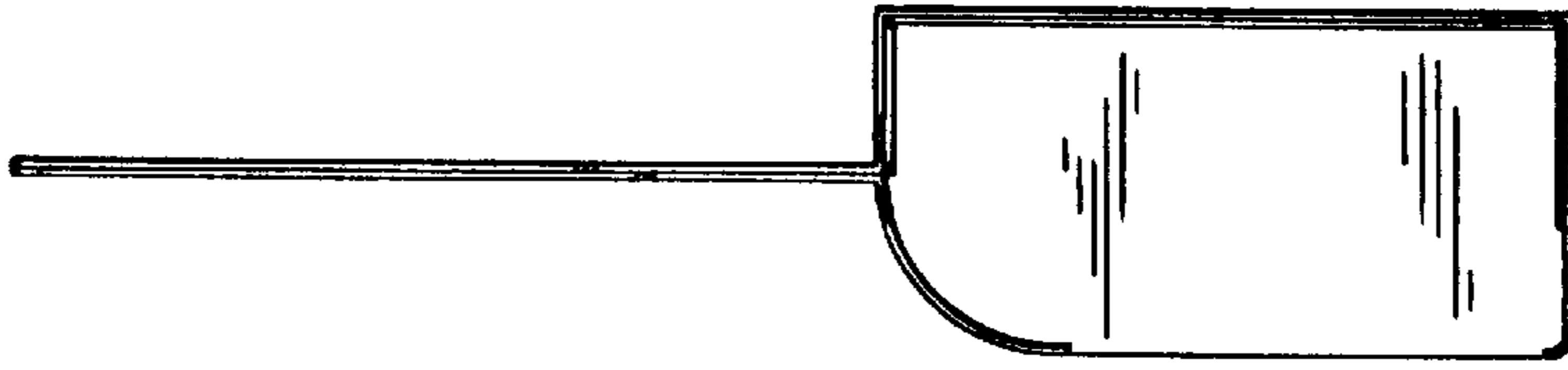

FIG. 5

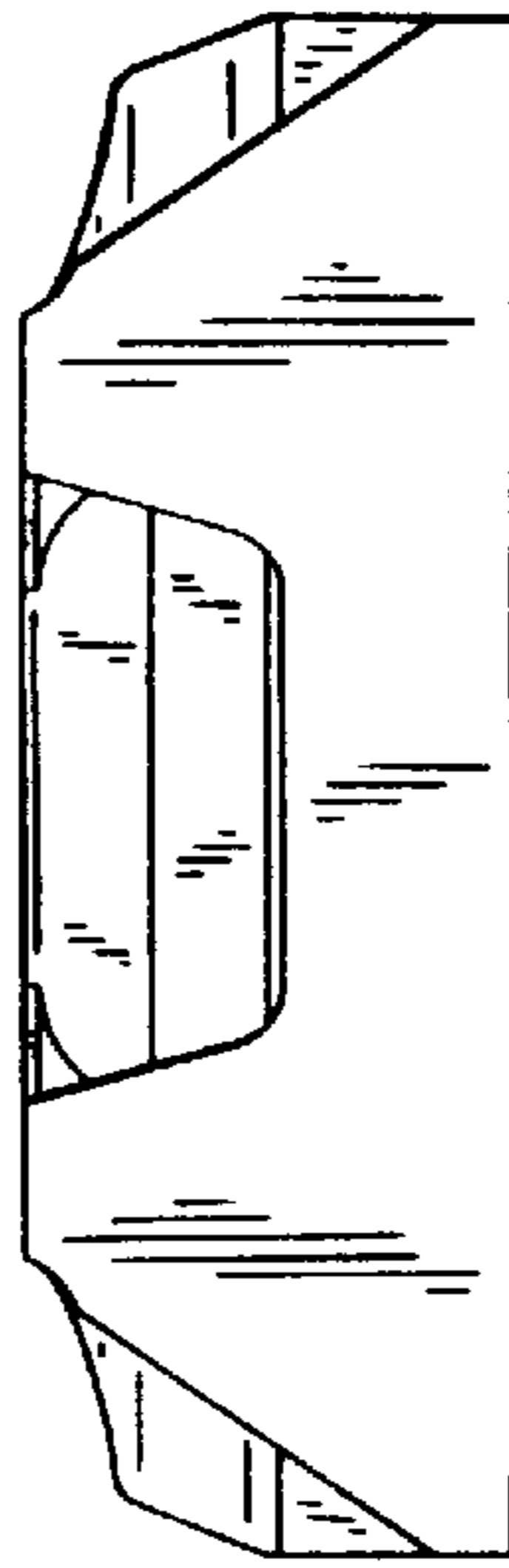

FIG. 8

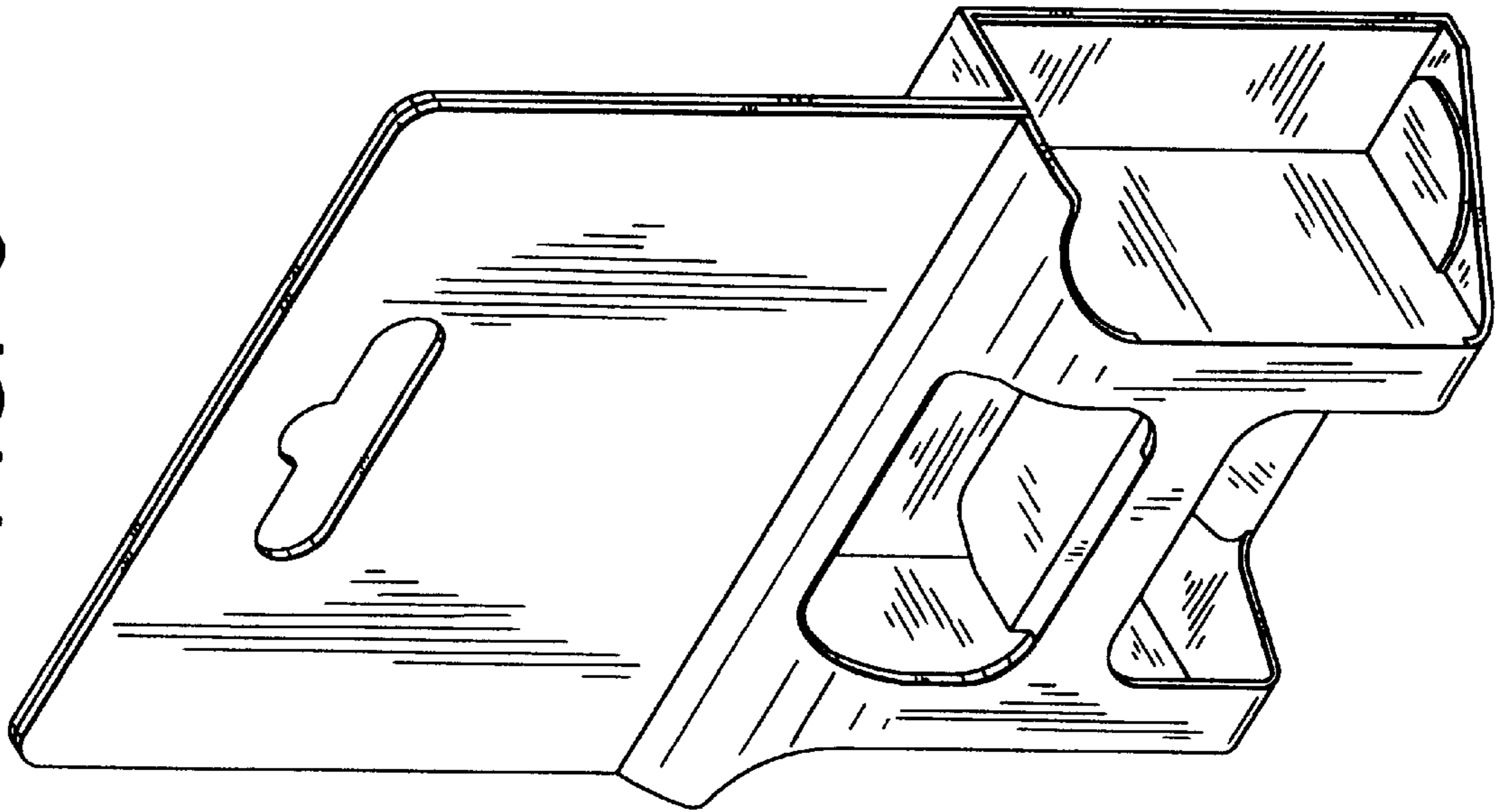

FIG. 10

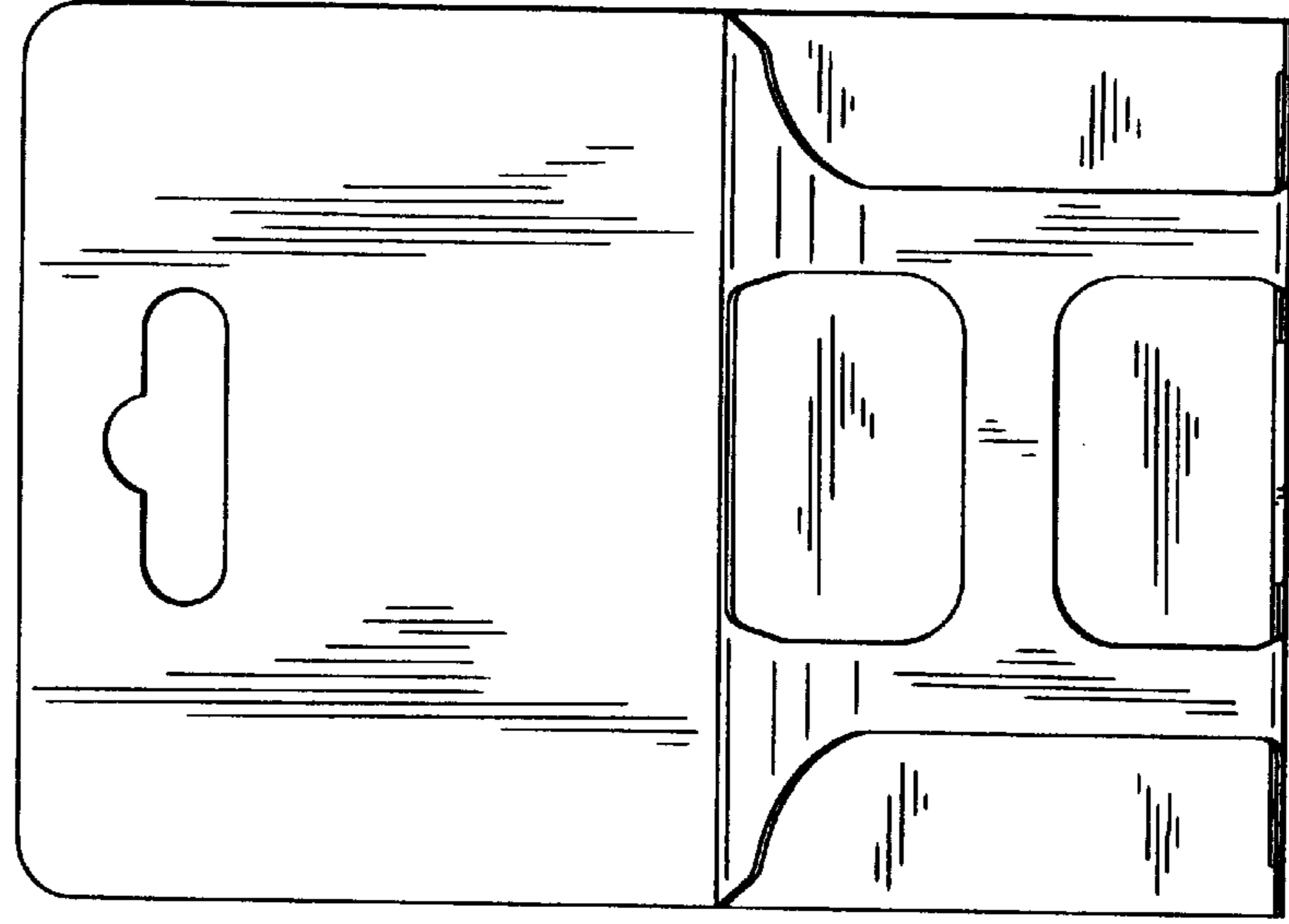

FIG. 9

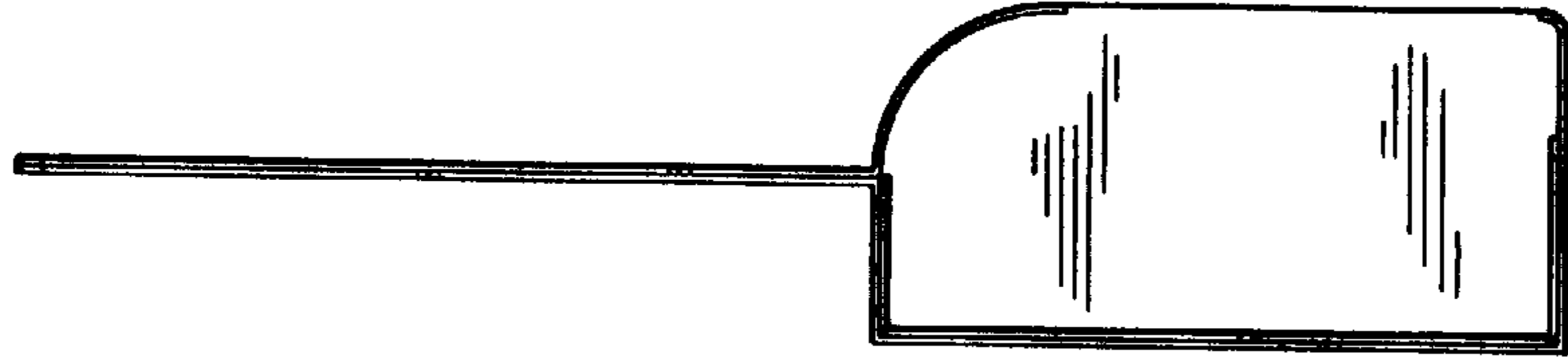

FIG. 11

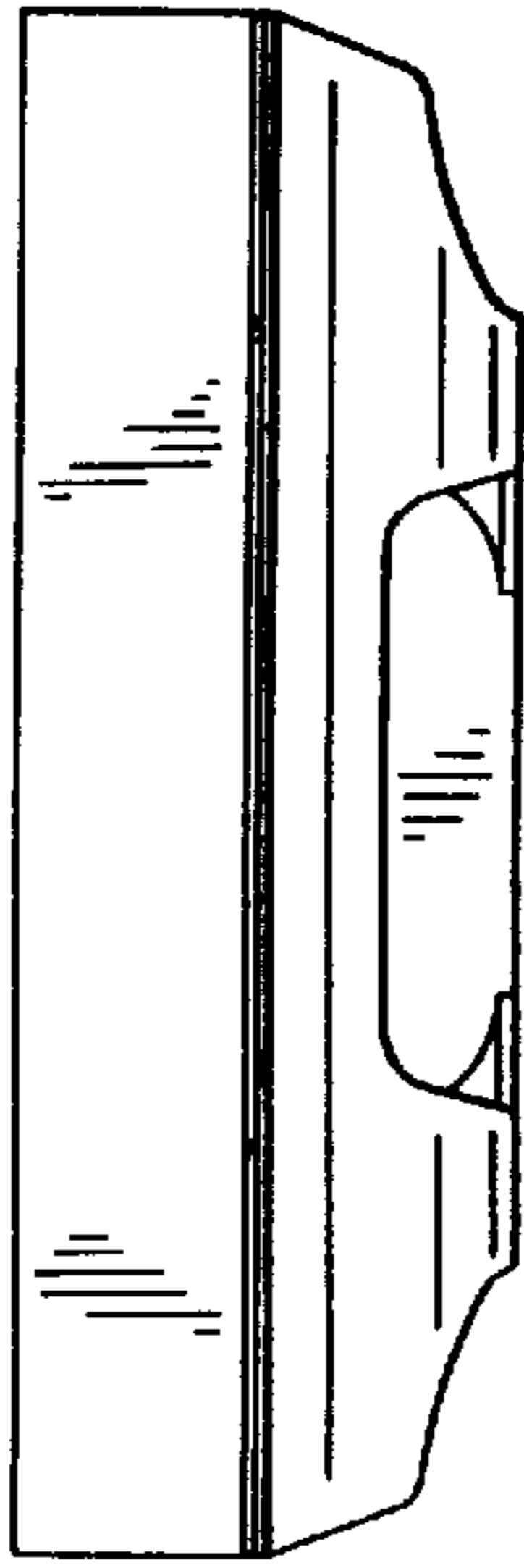

FIG. 14

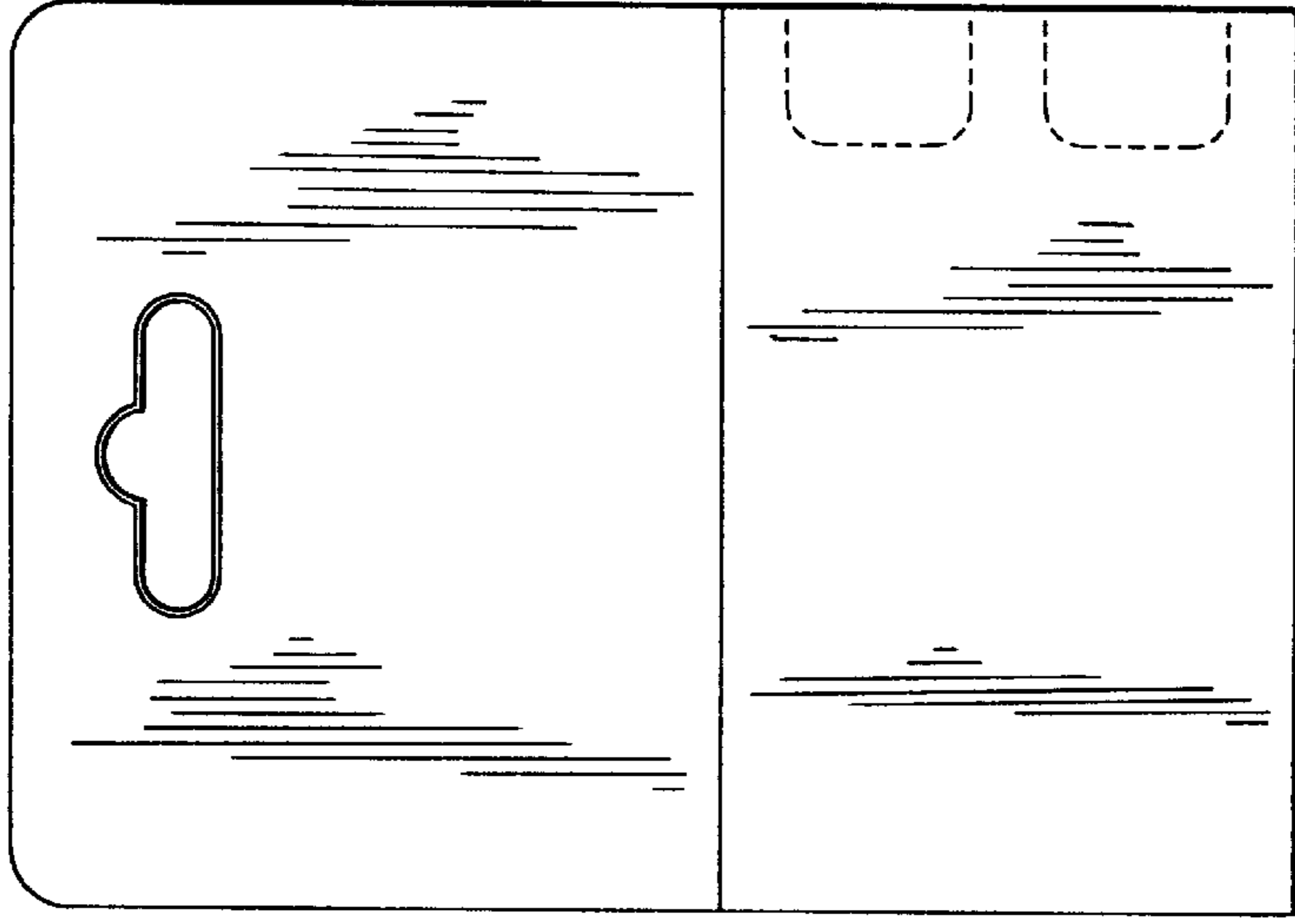

FIG. 13

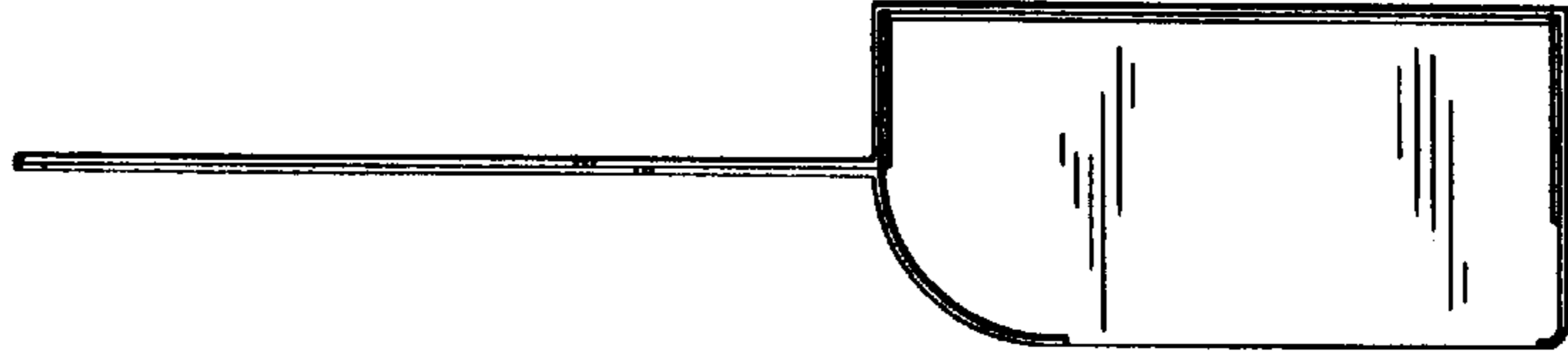

FIG. 12

