



US00D429987S

United States Patent [19] Hung

[11] Patent Number: **Des. 429,987**

[45] Date of Patent: **** Aug. 29, 2000**

[54] **MULTI-PURPOSE TOOL**

[76] Inventor: **Yu-Hsi Hung**, No. 2, Alley 30, Lane 73, Tzute Rd., Tali City, Taichung Hsien, Taiwan

[**] Term: **14 Years**

[21] Appl. No.: **29/100,139**

[22] Filed: **Feb. 5, 1999**

[51] **LOC (7) Cl.** **08-05**

[52] **U.S. Cl.** **D8/105; D8/26; D8/81**

[58] **Field of Search** D8/105, 26, 99, D8/55, 81, 87, 21, 28, 29; 30/161, 164, 153, 152; 7/118, 125-135, 138, 168, 143, 164, 170, 144, 146; 81/177.1, 177.2, 177.6, 427.5, 440

[56] **References Cited**

U.S. PATENT DOCUMENTS

D. 274,032	5/1984	Lai	D8/55
D. 281,216	11/1985	Cutliff, Jr. et al.	D8/26
D. 331,690	12/1992	Villarreal	D8/81
D. 367,807	3/1996	Hung	D8/105
D. 419,050	1/2000	Lin	D8/105
D. 419,418	1/2000	Lin	D8/105
554,225	2/1896	ush	7/138
854,891	5/1907	Huffman	7/168
966,015	8/1910	Hansen	7/127

1,107,701	8/1914	Plein	7/146 X
1,598,420	8/1926	Brossett	7/144 X
1,644,352	10/1927	Perrin	7/137 X
1,660,836	2/1928	Gilks	7/138
1,664,594	4/1928	Cummings	7/143
5,769,094	6/1998	Jenkins, Jr. et al.	30/161

Primary Examiner—Jeffrey Asch
Attorney, Agent, or Firm—Kolisch Hartwell Dickinson McCormack & Heuser

[57] **CLAIM**

The ornamental design for a multi-purpose tool, as shown and described.

DESCRIPTION

FIG. 1 is a front-left-top perspective view of a multi-purpose tool, showing my new design;
FIG. 2 is a front elevational view thereof;
FIG. 3 is a rear elevational view thereof;
FIG. 4 is a left side view thereof;
FIG. 5 is a right side view thereof;
FIG. 6 is a top plan view thereof;
FIG. 7 is a bottom plan view thereof; and,
FIG. 8 is a front elevational view of an embodiment of the multi-purpose tool, with a knife blade, two saw blades and a pair of scissors pivoted from the handle of the multi-purpose tool of my new design.

1 Claim, 6 Drawing Sheets

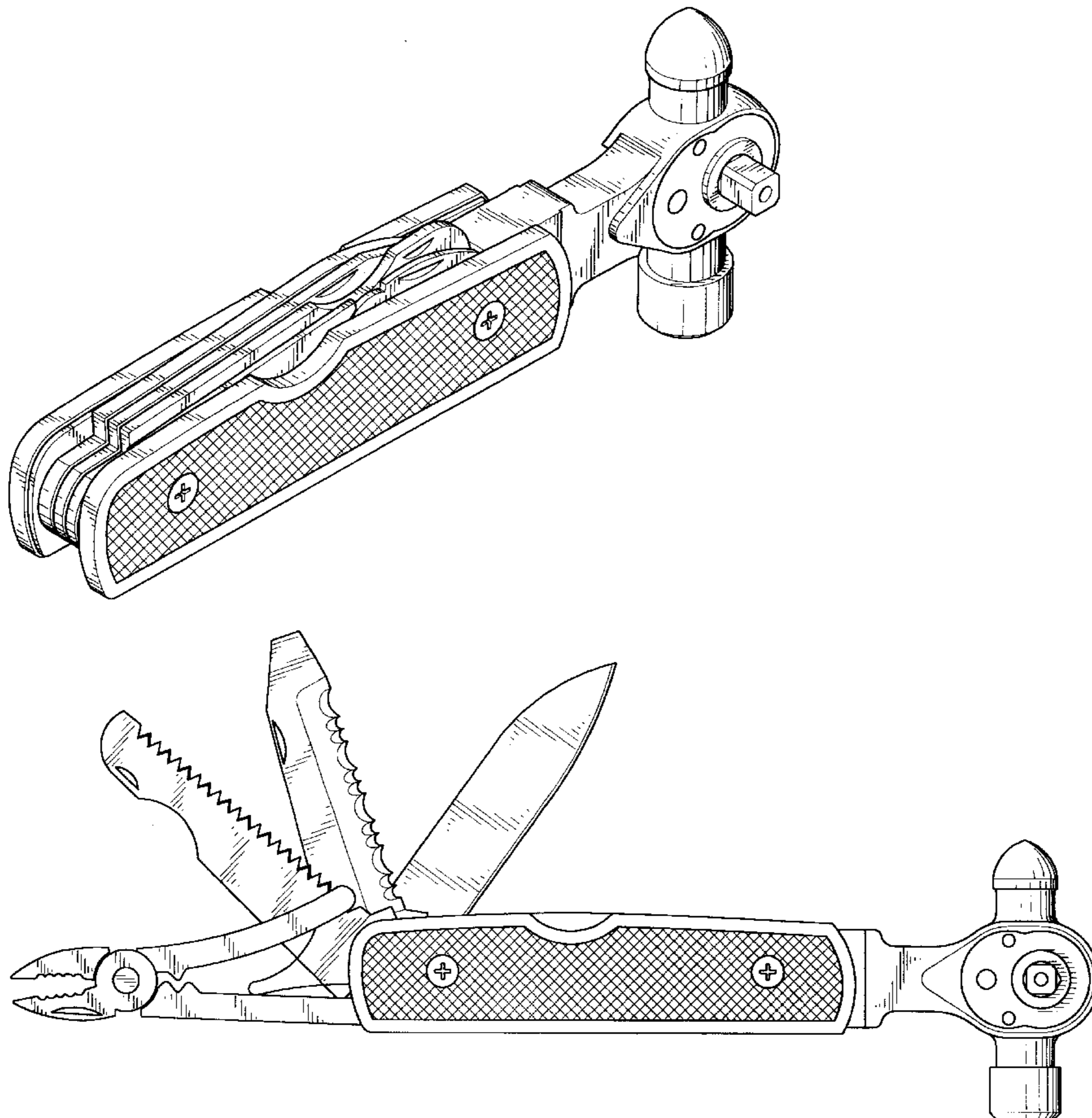

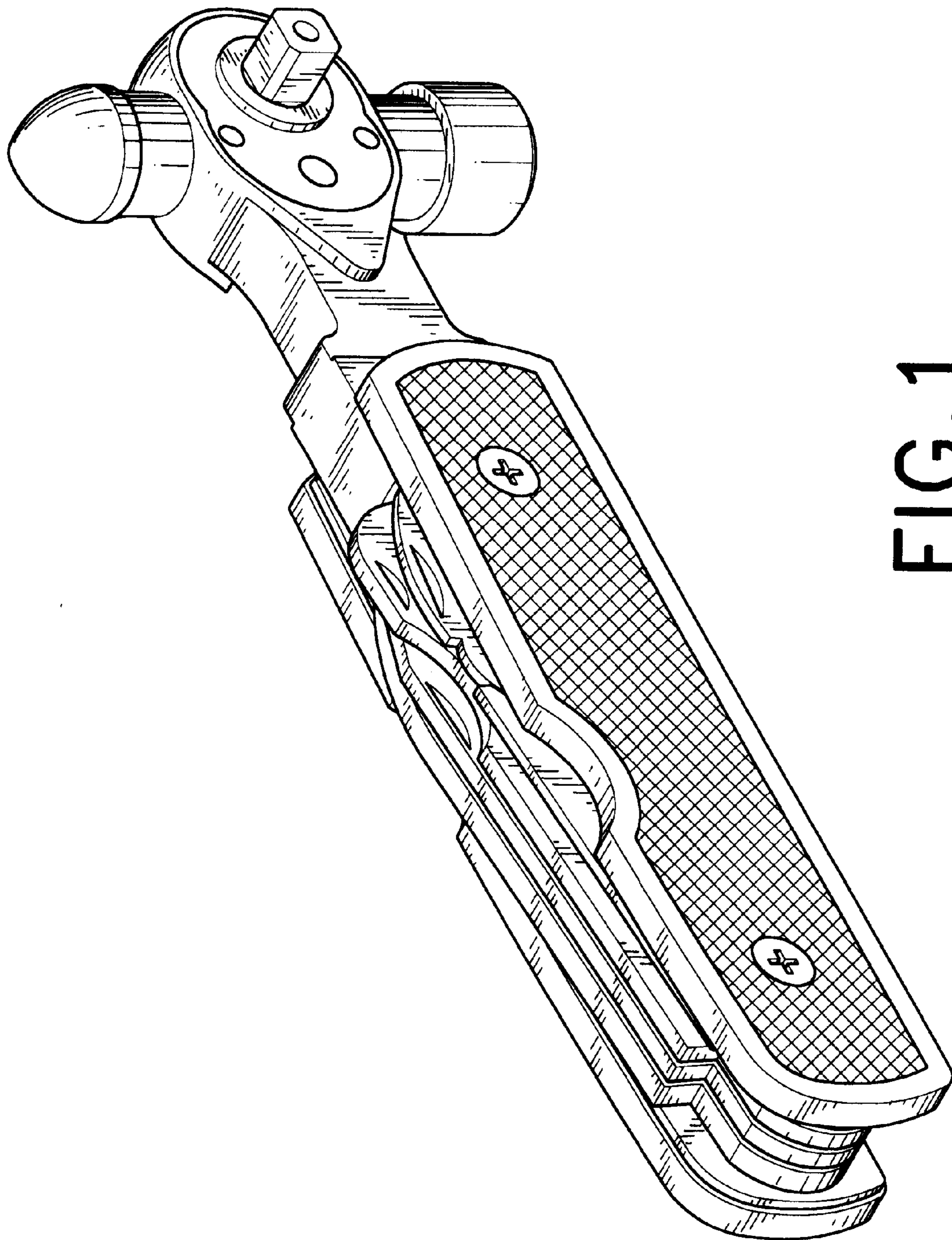

FIG. 1

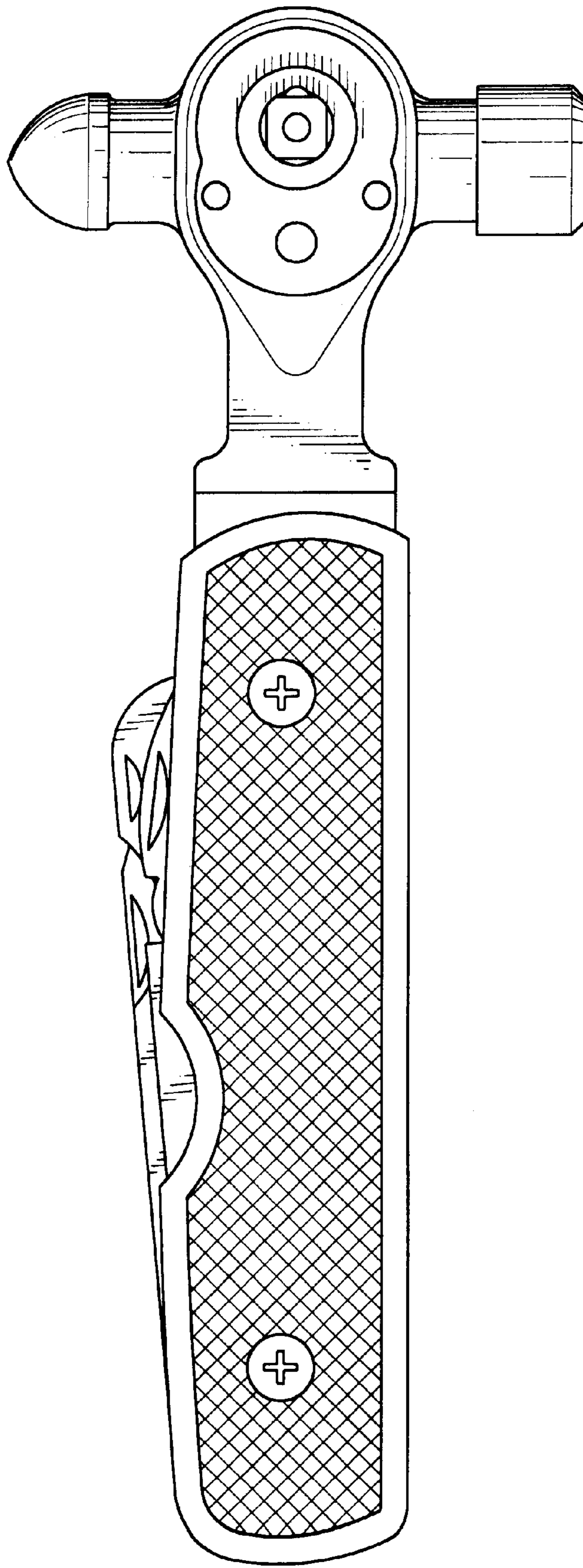

FIG. 2

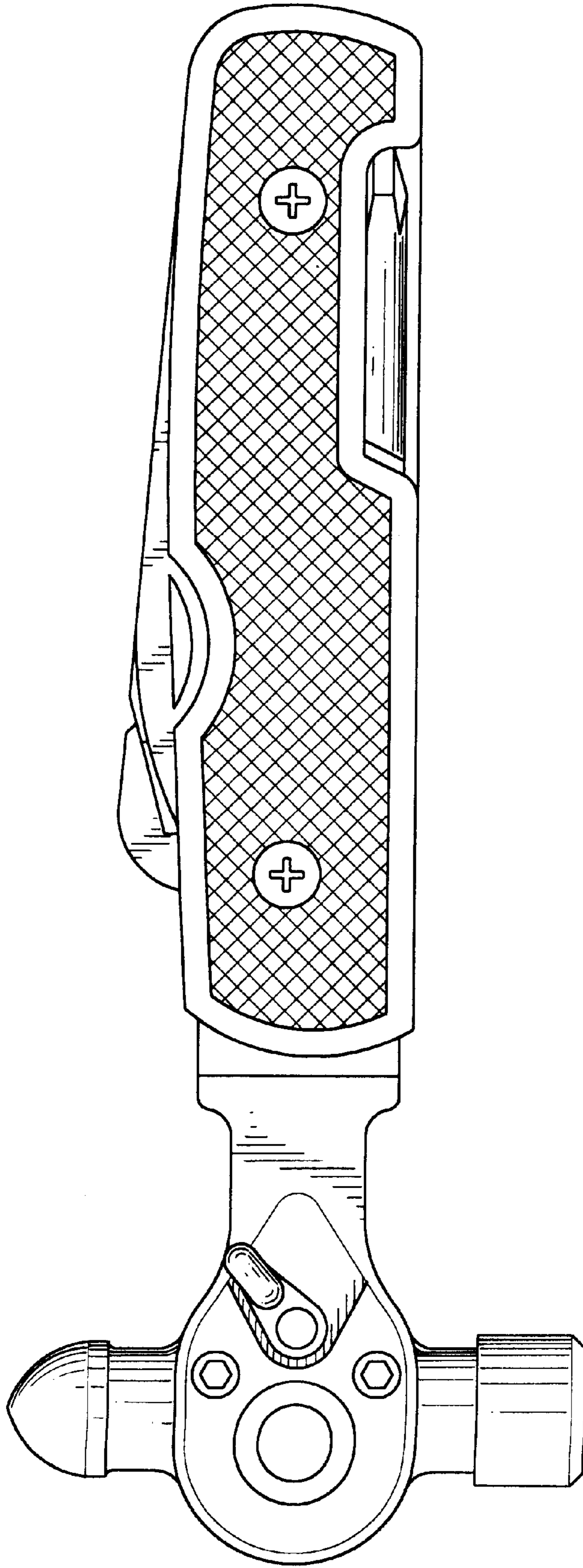

FIG. 3

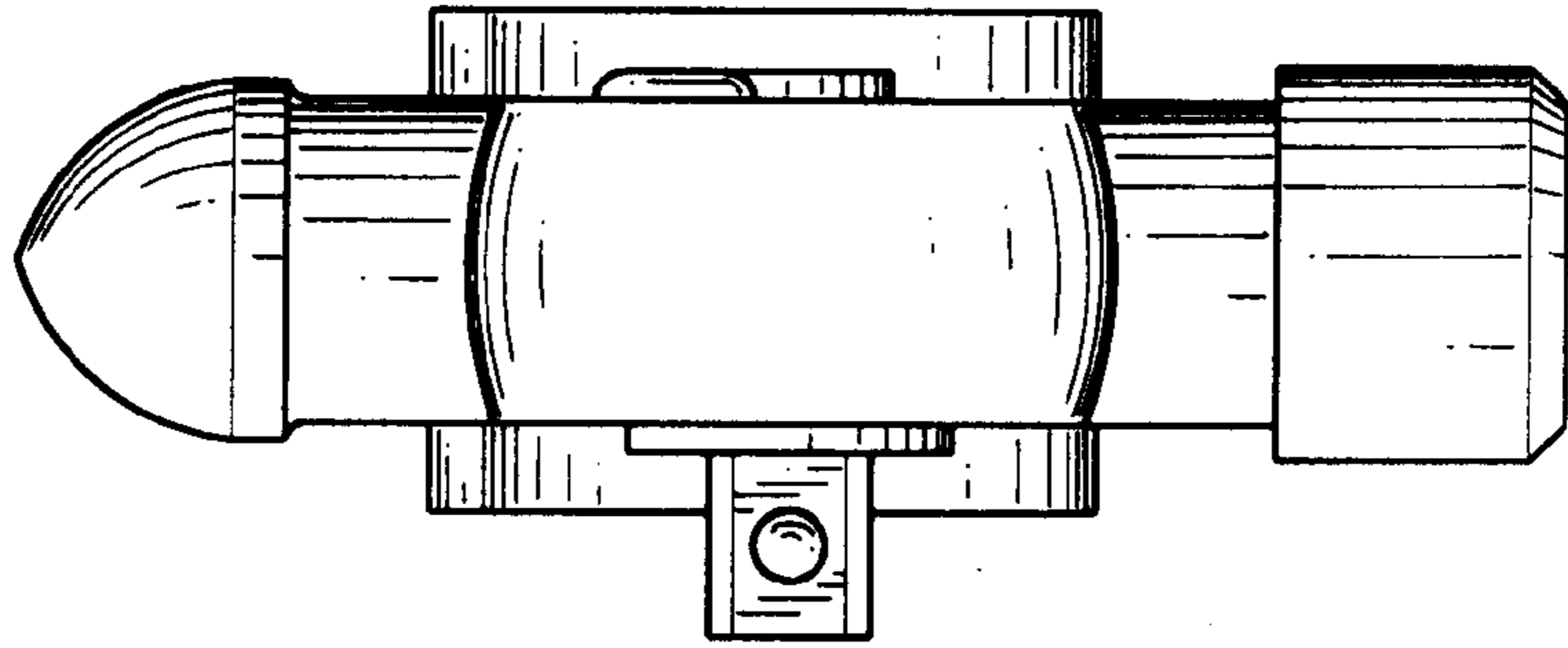

FIG. 5

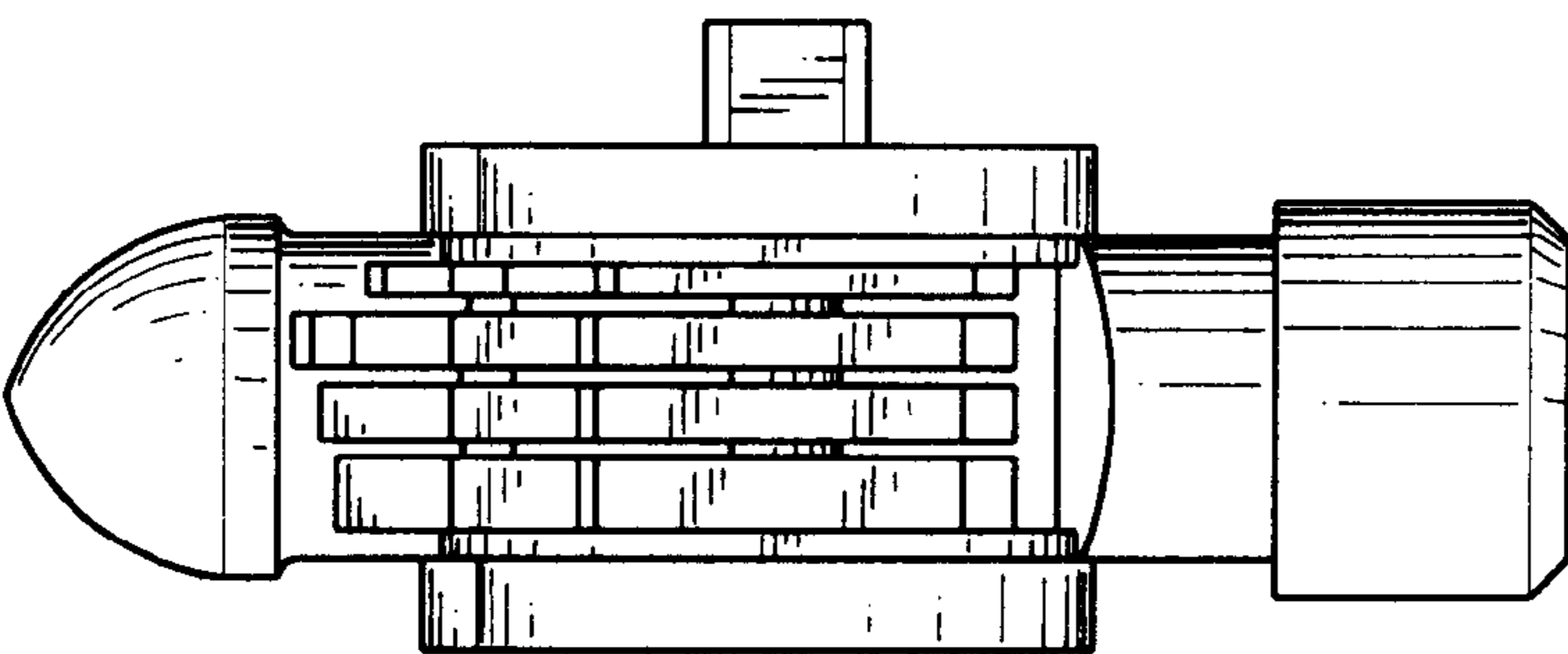

FIG. 4

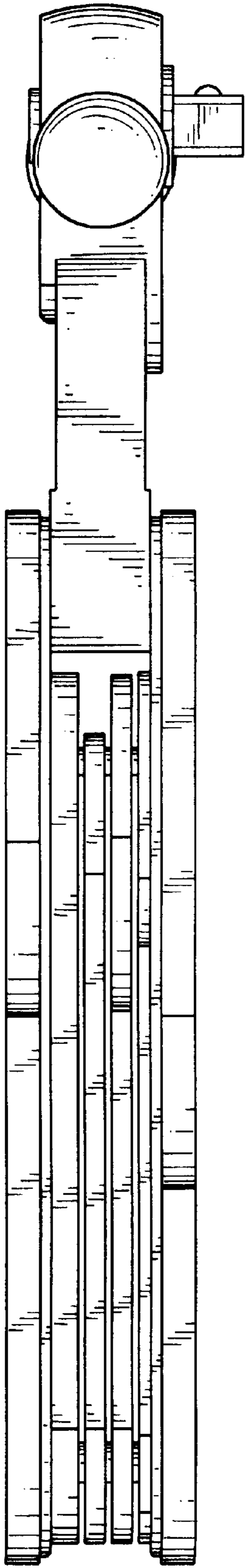

FIG. 6

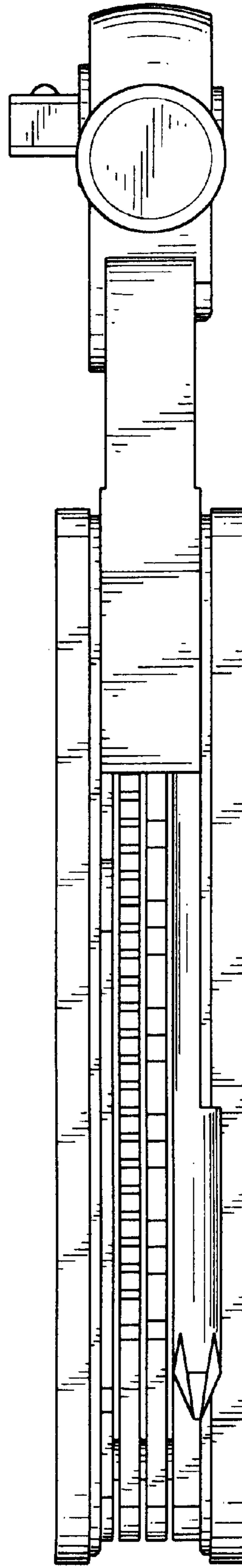

FIG. 7

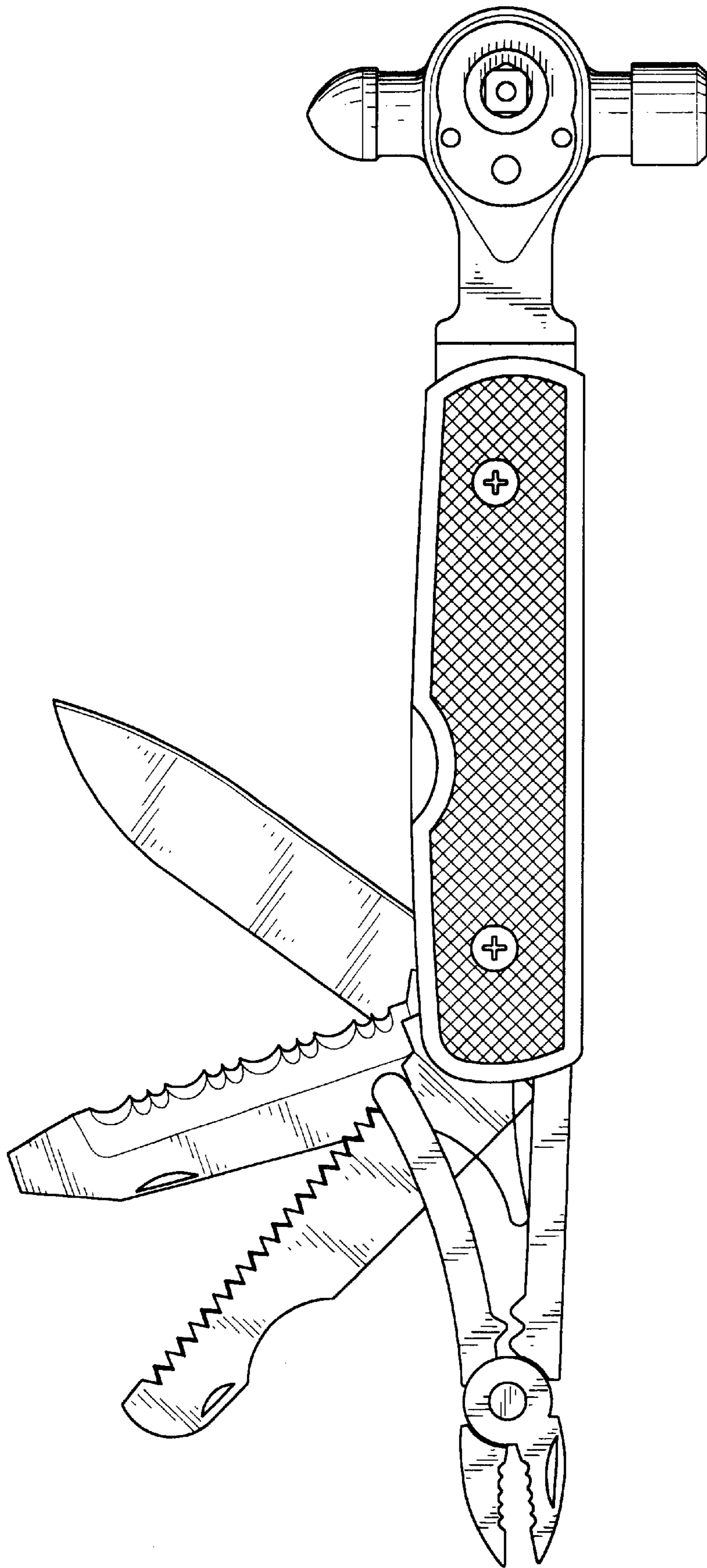

FIG. 8