



US00D429968S

United States Patent [19]
Frankel

[11] **Patent Number: Des. 429,968**

[45] **Date of Patent: ** Aug. 29, 2000**

[54] **ATTACHABLE DRINK HOLDER**

[75] Inventor: **Gail Frankel**, Dallas, Tex.

[73] Assignee: **Kel-Gar, Inc.**, Dallas, Tex.

[**] Term: **14 Years**

[21] Appl. No.: **29/112,251**

[22] Filed: **Oct. 13, 1999**

[51] **LOC (7) Cl.** **07-06**

[52] **U.S. Cl.** **D7/620; D7/608**

[58] **Field of Search** D7/619-625; 211/71.01,
211/74; 248/311.2, 346.11; 220/737, 739

[56] **References Cited**

U.S. PATENT DOCUMENTS

D. 266,834 11/1982 Sinkhorn et al. D7/608 X
5,503,297 4/1996 Frankel 220/737 X

OTHER PUBLICATIONS

Gott brochure, beverage holder, left side, p. 5, Mar. 1987.

Primary Examiner—Terry A. Wallace
Attorney, Agent, or Firm—Haynes and Boone, LLP

[57] **CLAIM**

The ornamental design for an attachable drink holder, as shown and described.

DESCRIPTION

FIG. 1 is a perspective view taken from the top, front and left side of a first embodiment of an attachable drink holder showing my new design.

FIG. 2 is a top plan view thereof.

FIG. 3 is a bottom plan view thereof.

FIG. 4 is a left side elevational view thereof, the right side being a mirror image of the left side.

FIG. 5 is a rear elevational view thereof.

FIG. 6 is a front elevational view thereof.

FIG. 7 is a second perspective view taken from the top, front and left side thereof showing the attachable drink holder of FIGS. 1-6 attached to a horizontal bar by a mounting assembly.

FIG. 8 is a perspective view taken from the top, front and left side of a second embodiment of the attachable drink holder.

FIG. 9 is a top plan view thereof.

FIG. 10 is a bottom plan view thereof.

FIG. 11 is a left side elevational view thereof, the right side being a mirror image of the left side.

FIG. 12 is a rear elevational view thereof; and,

FIG. 13 is a front elevational view thereof.

The broken line representations of a mounting assembly, a horizontal bar and a bottle are for the purpose of illustration only and form no part of the claimed design.

1 Claim, 7 Drawing Sheets

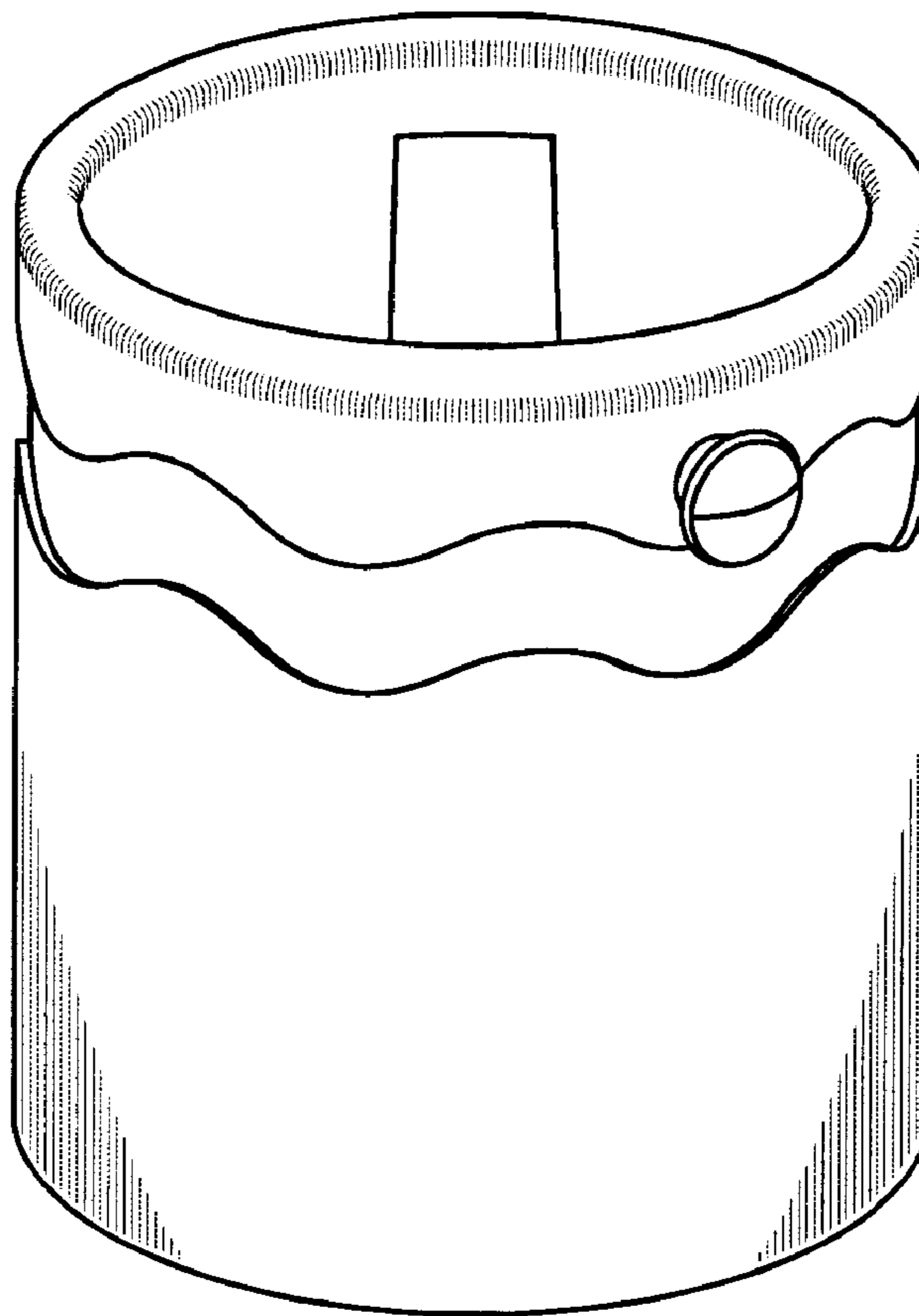

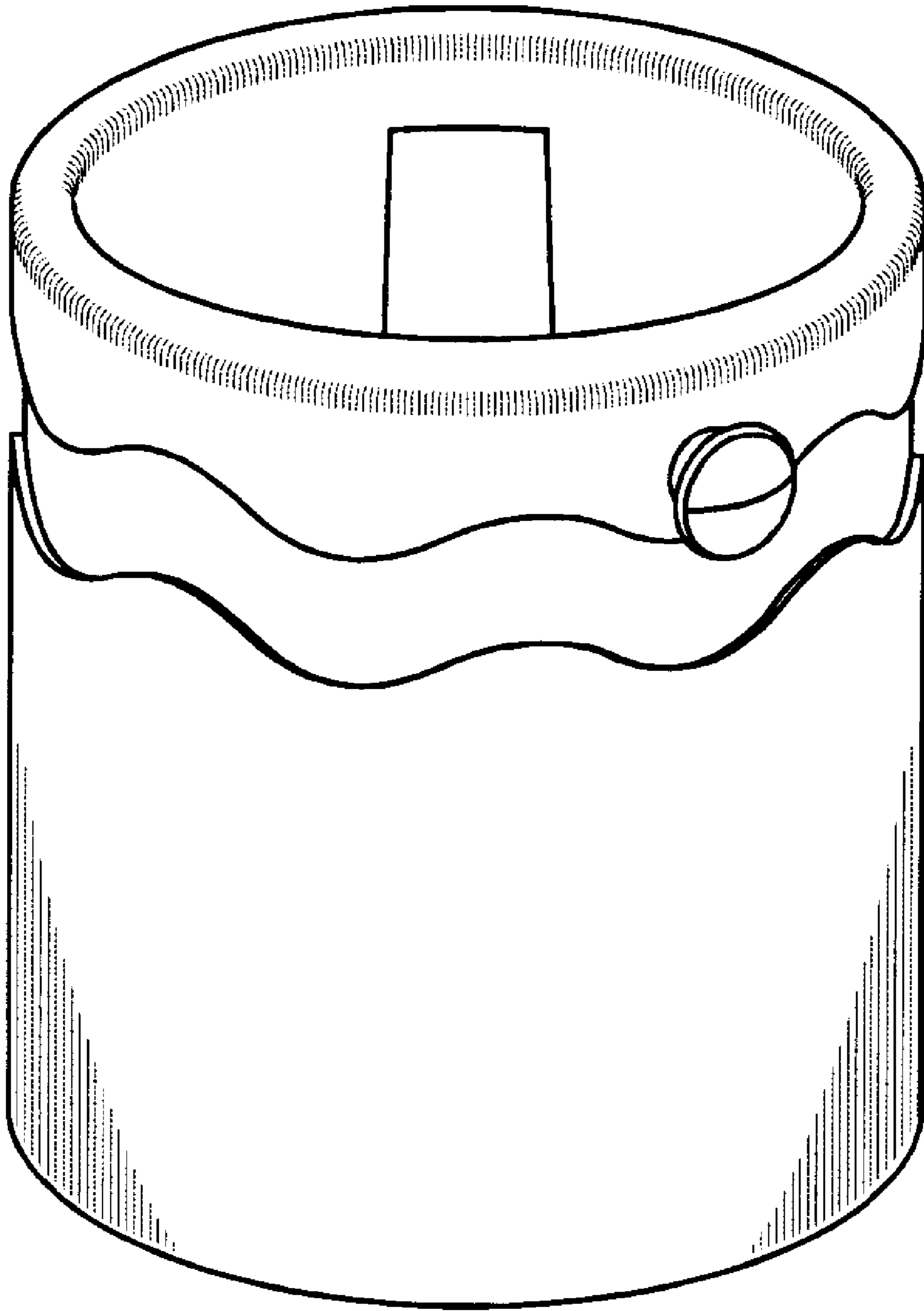

FIG. 1

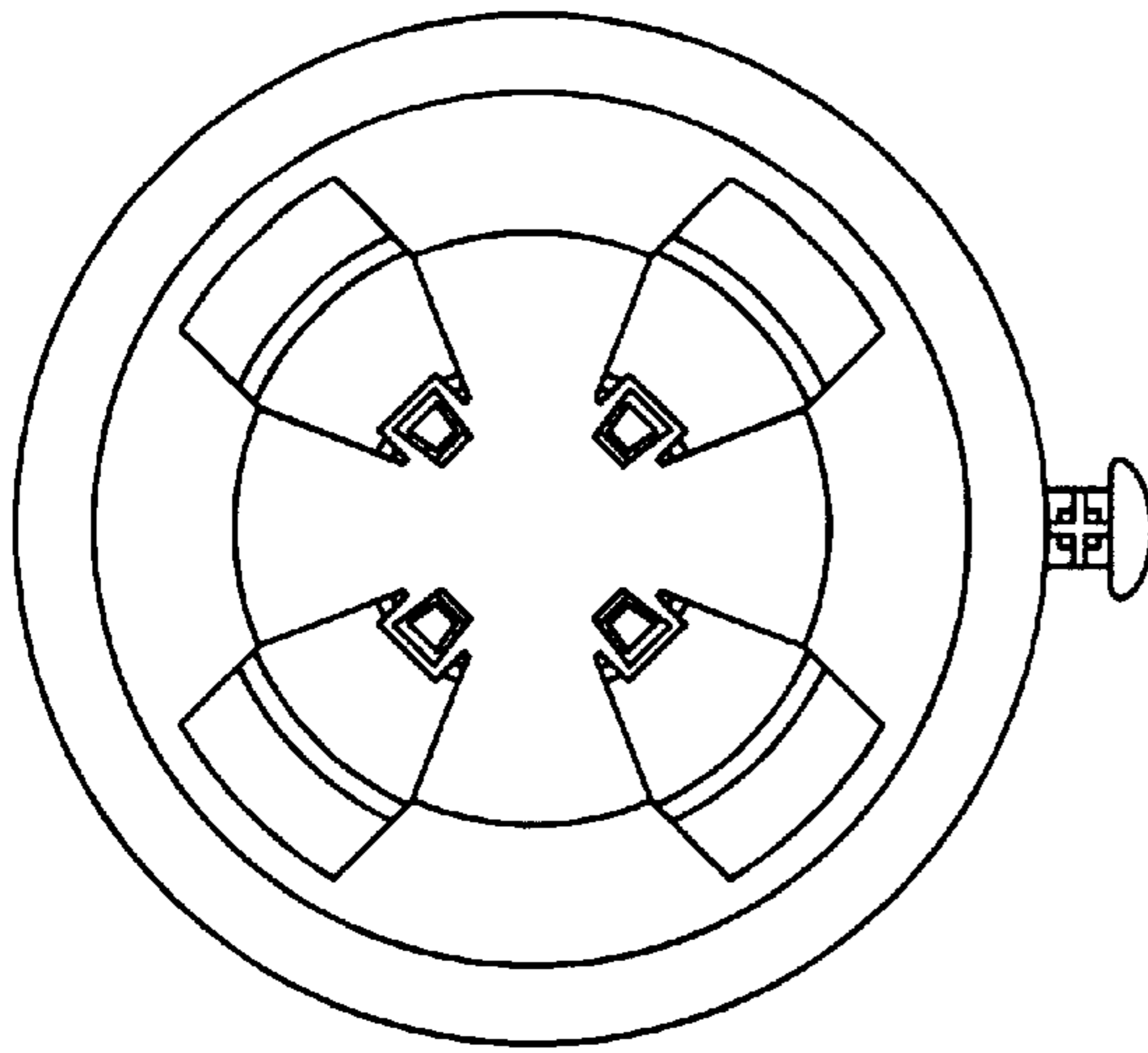

FIG. 2

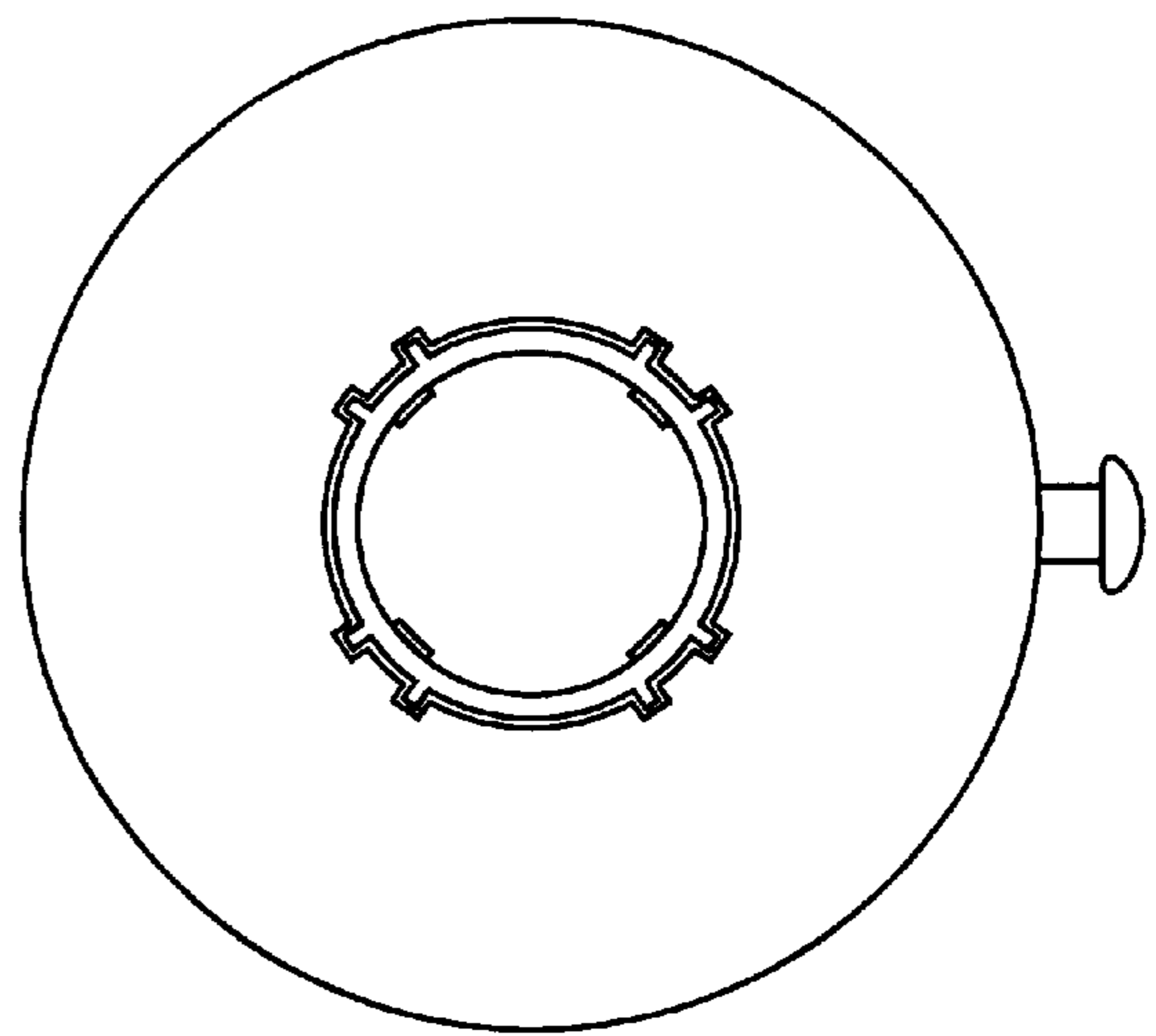

FIG. 3

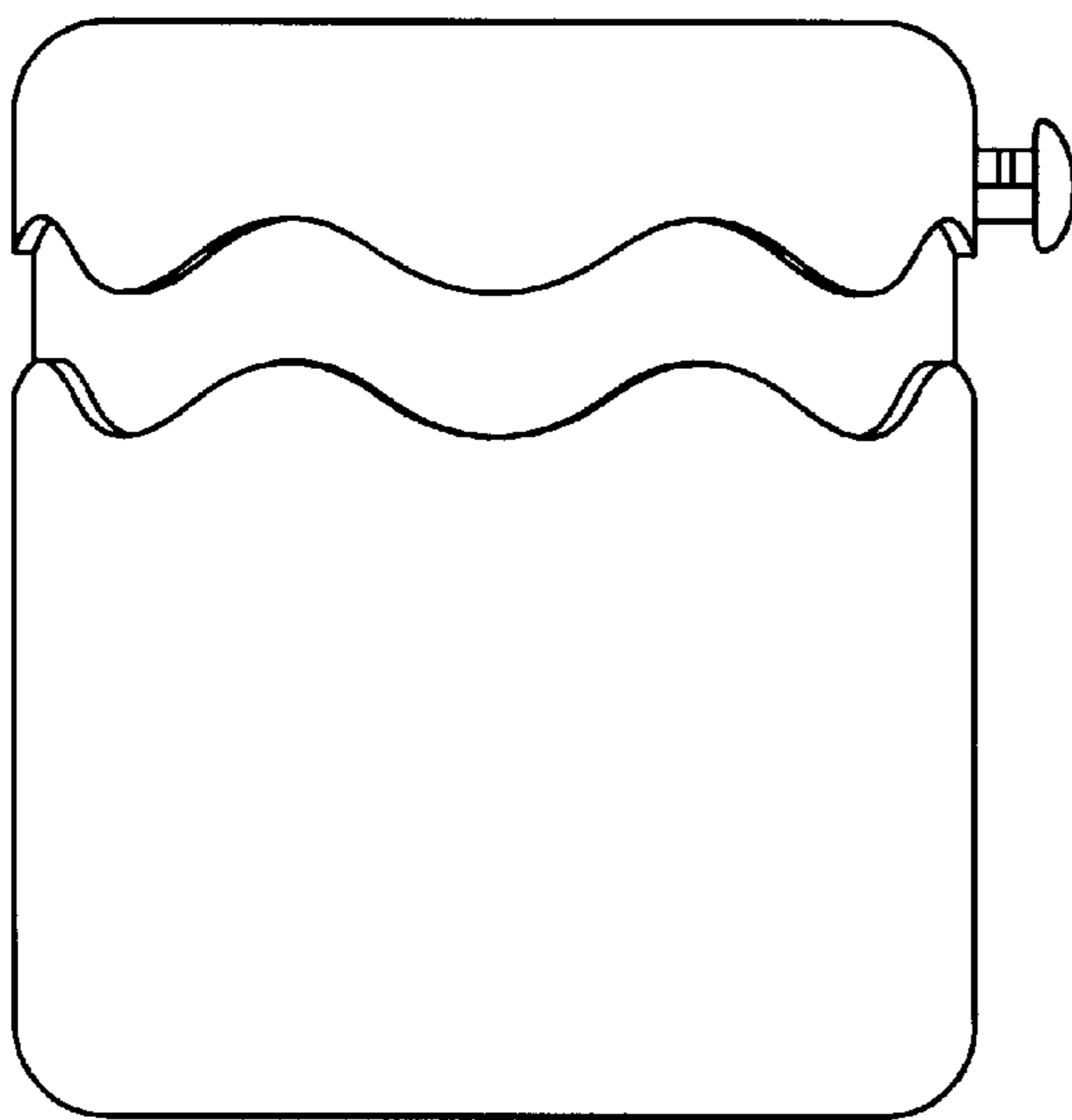

FIG. 4

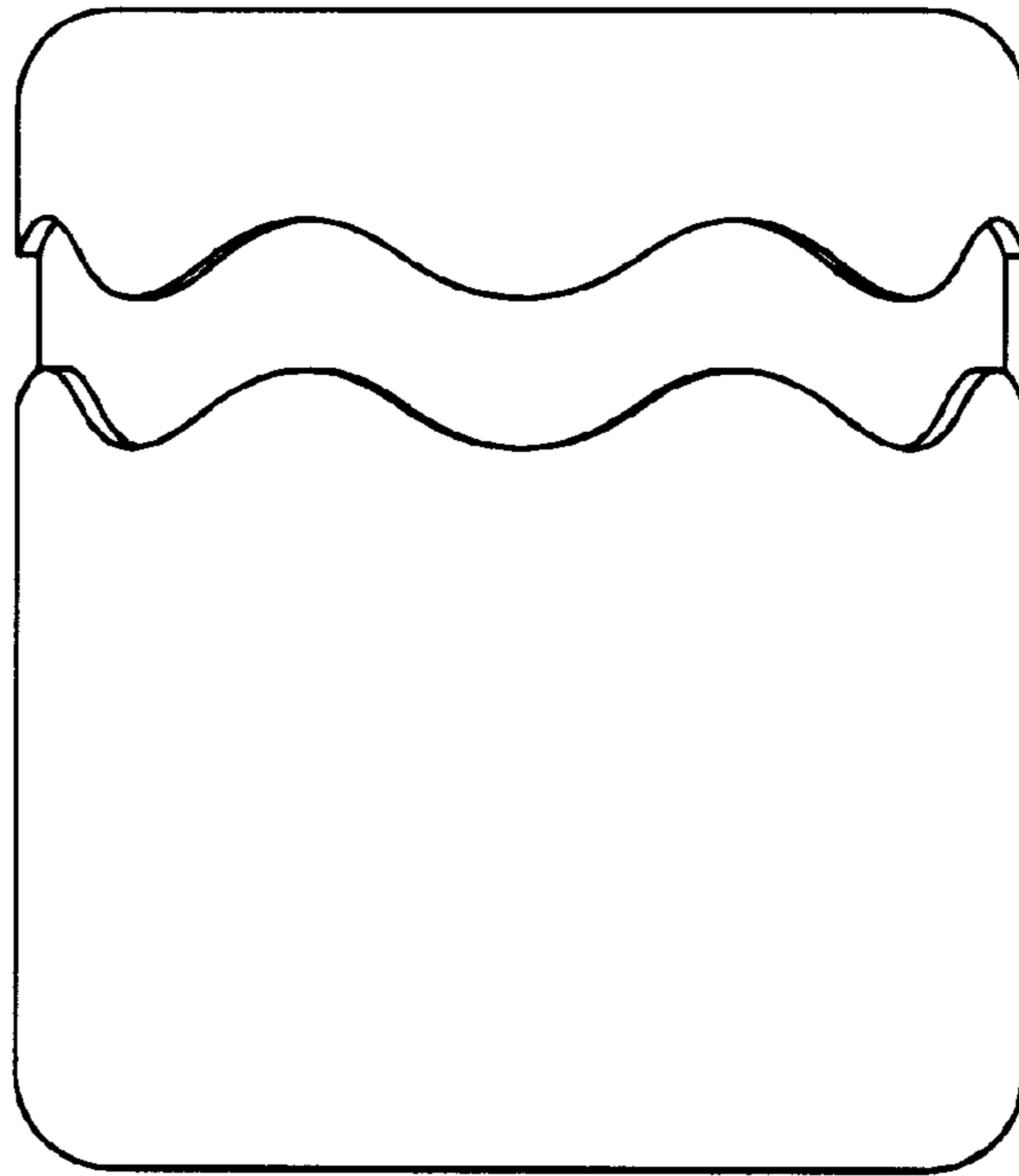

FIG. 5

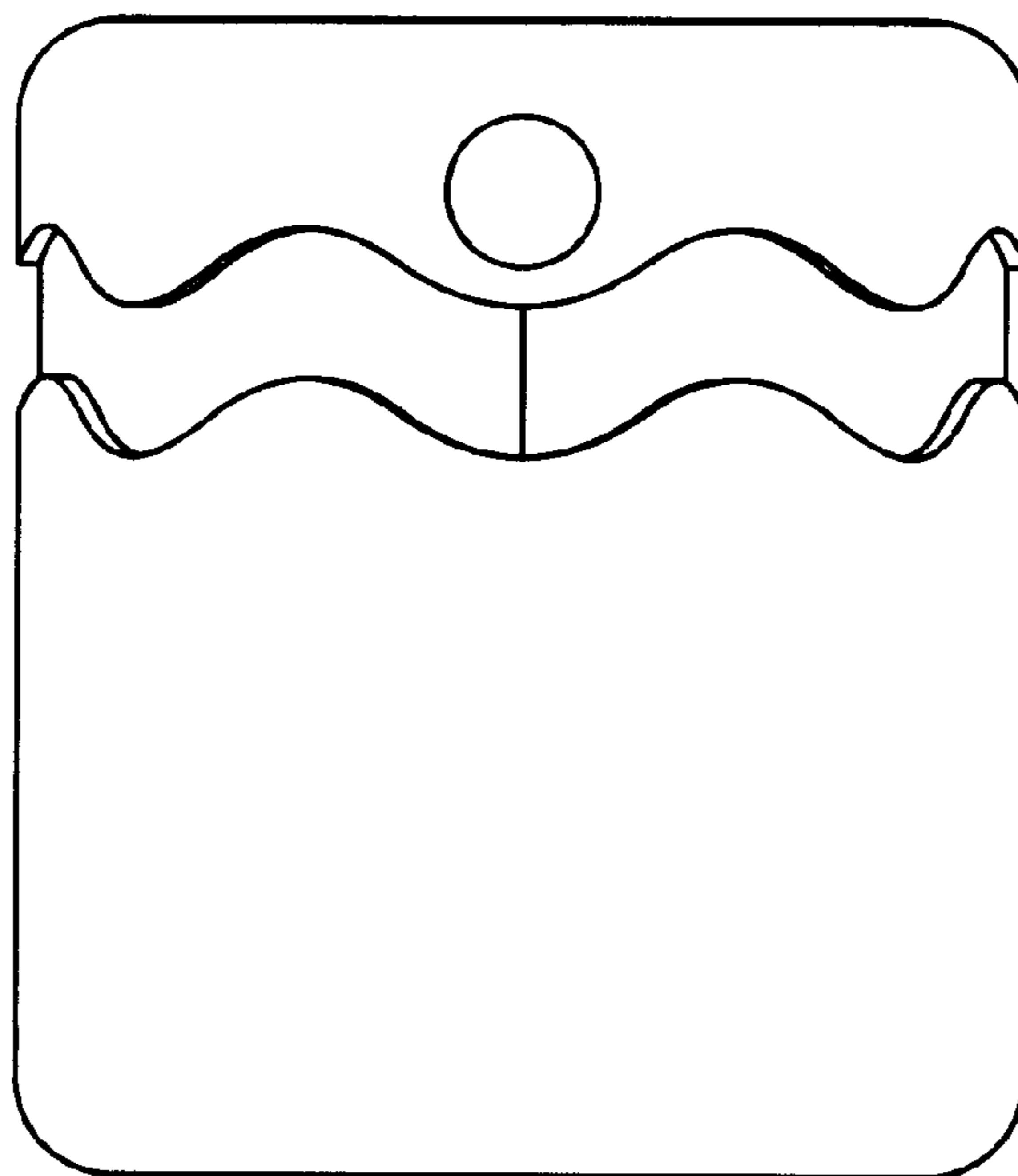

FIG. 6

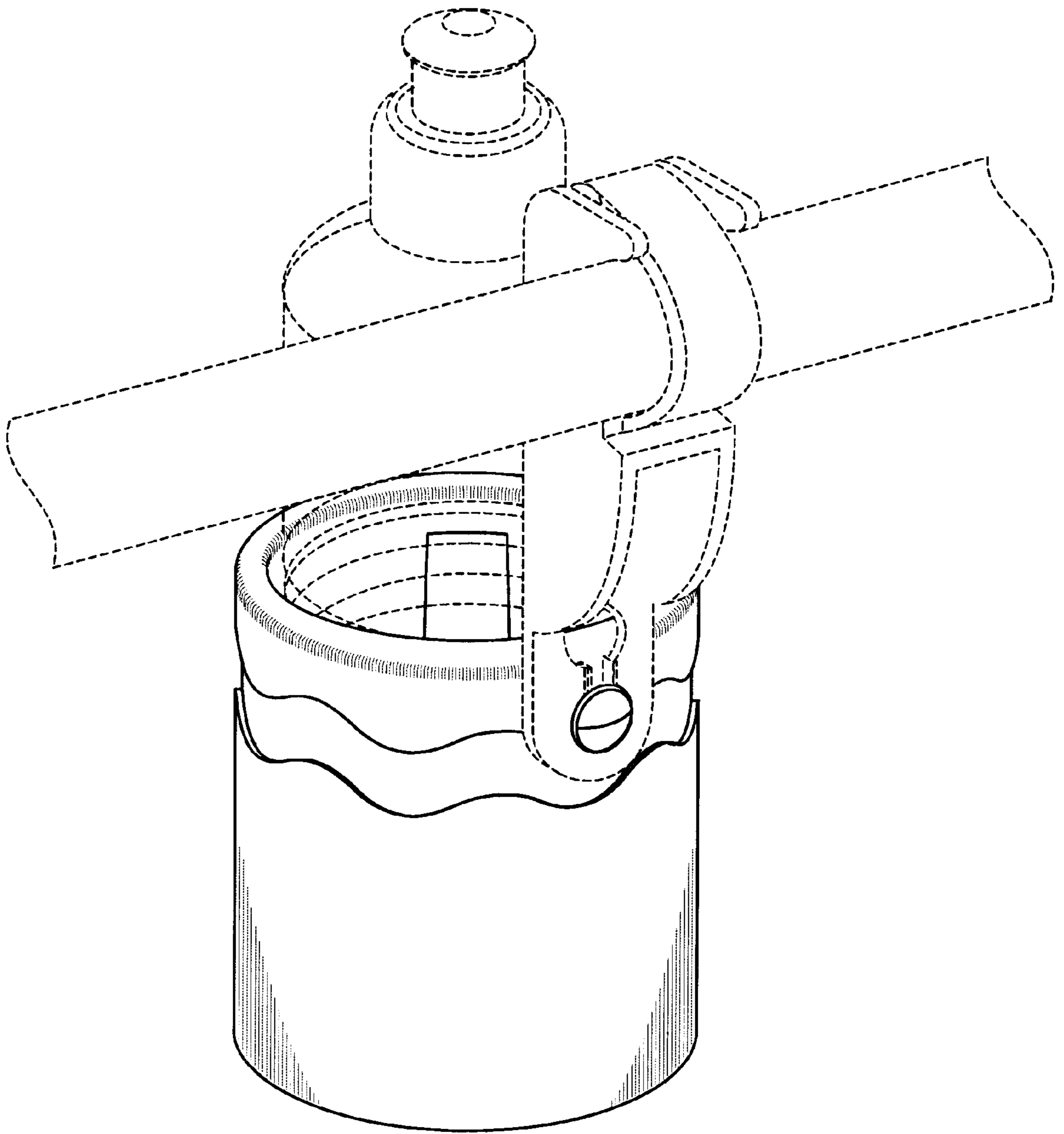

FIG. 7

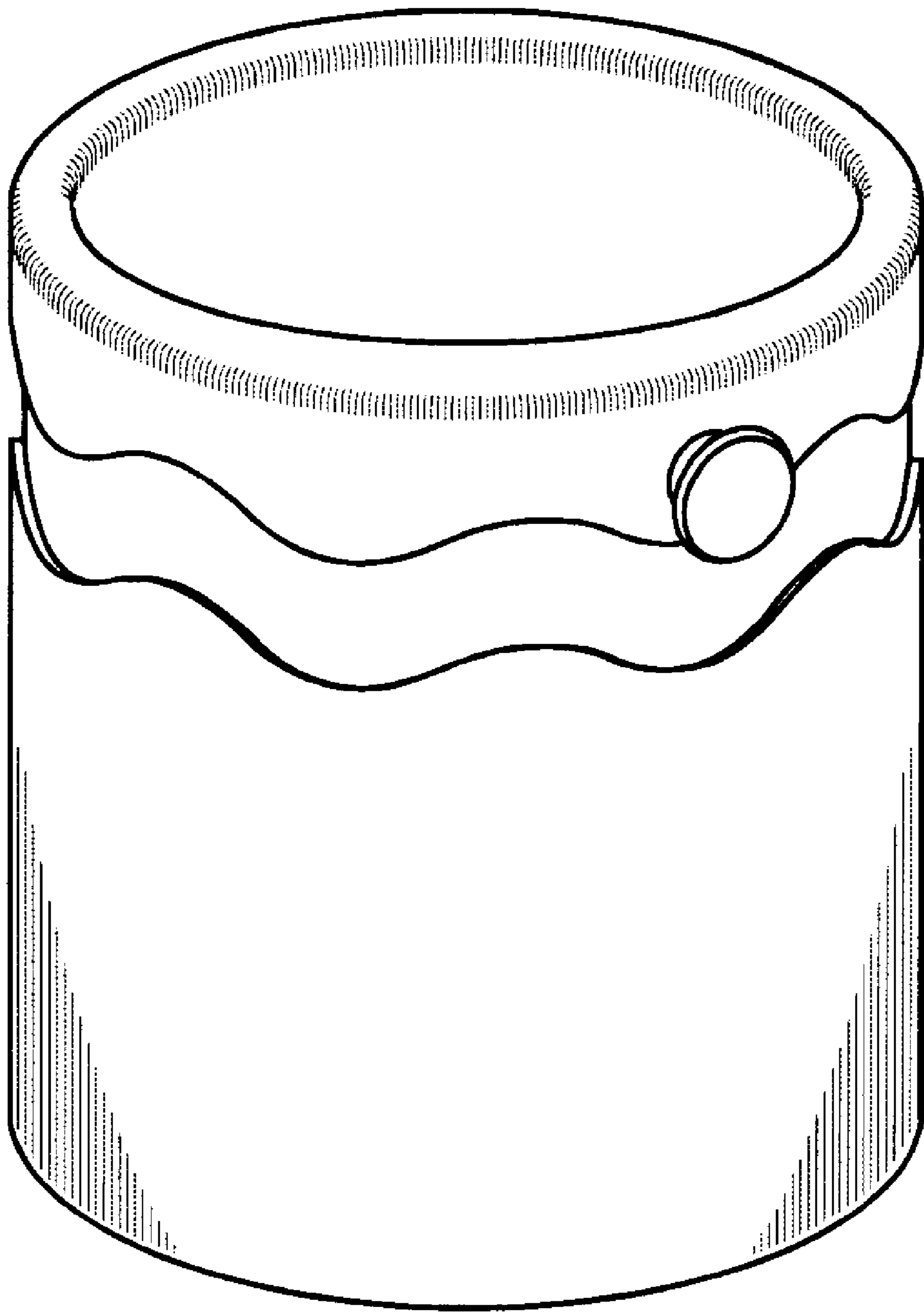

FIG. 8

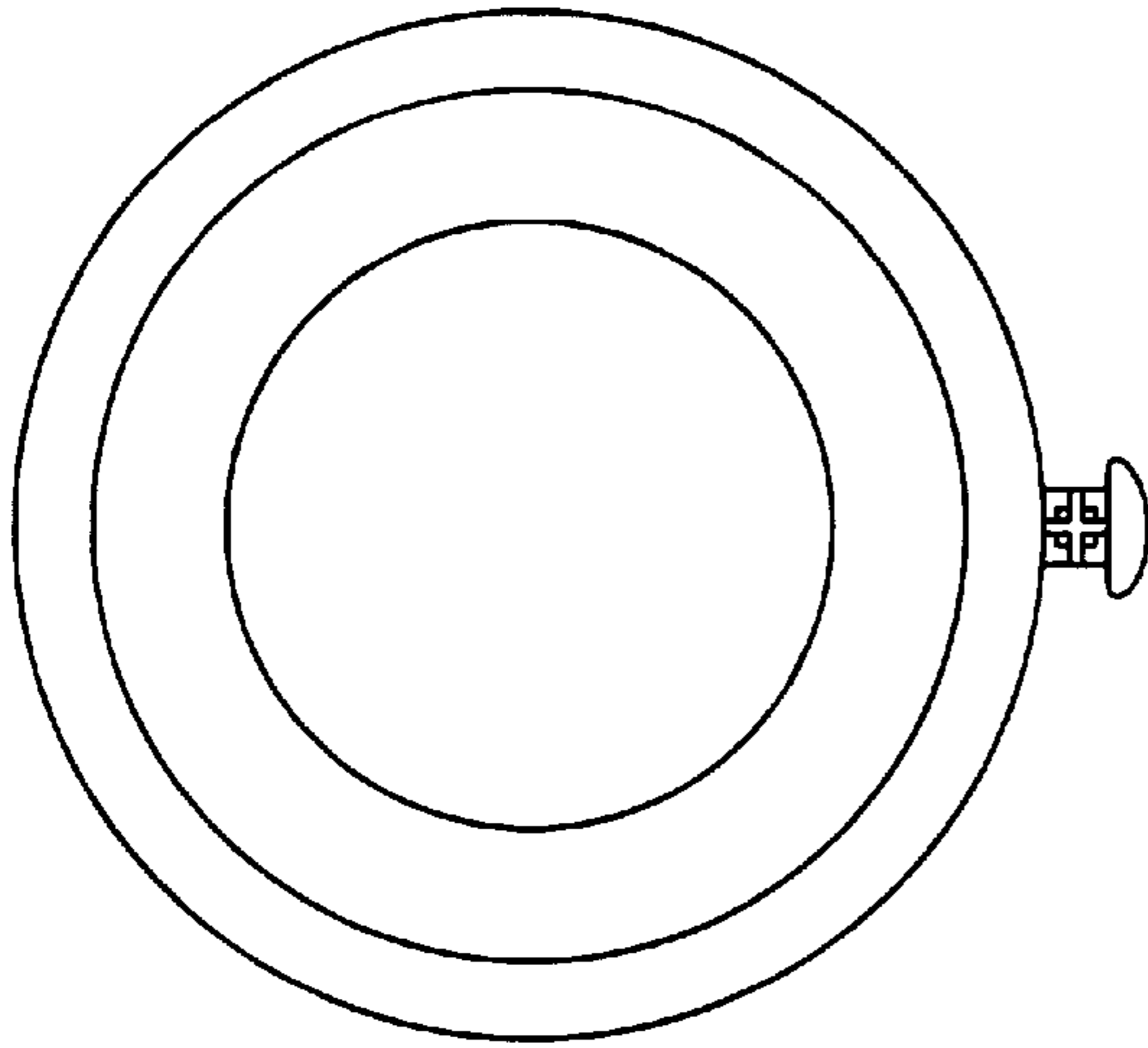

FIG. 9

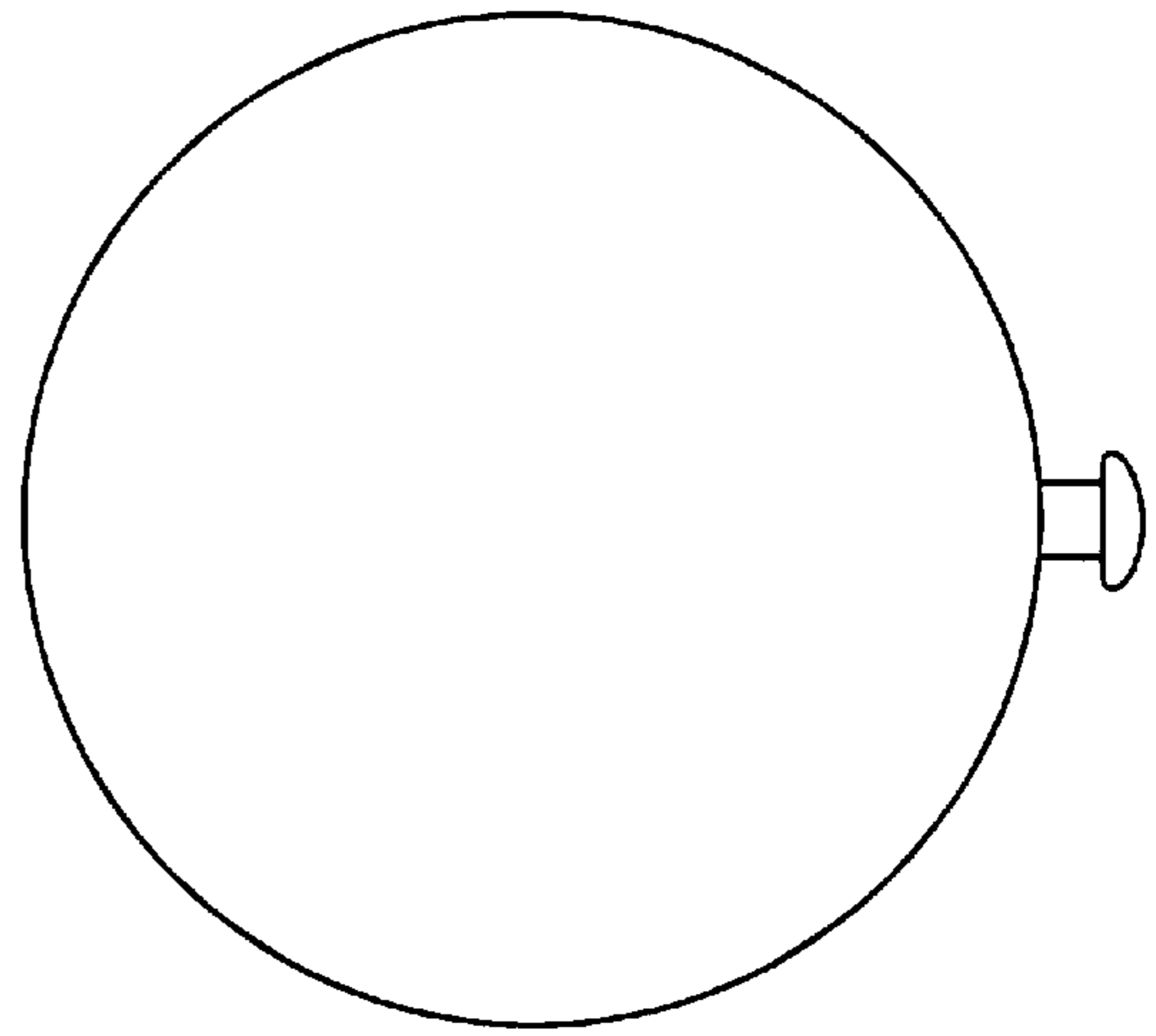

FIG. 10

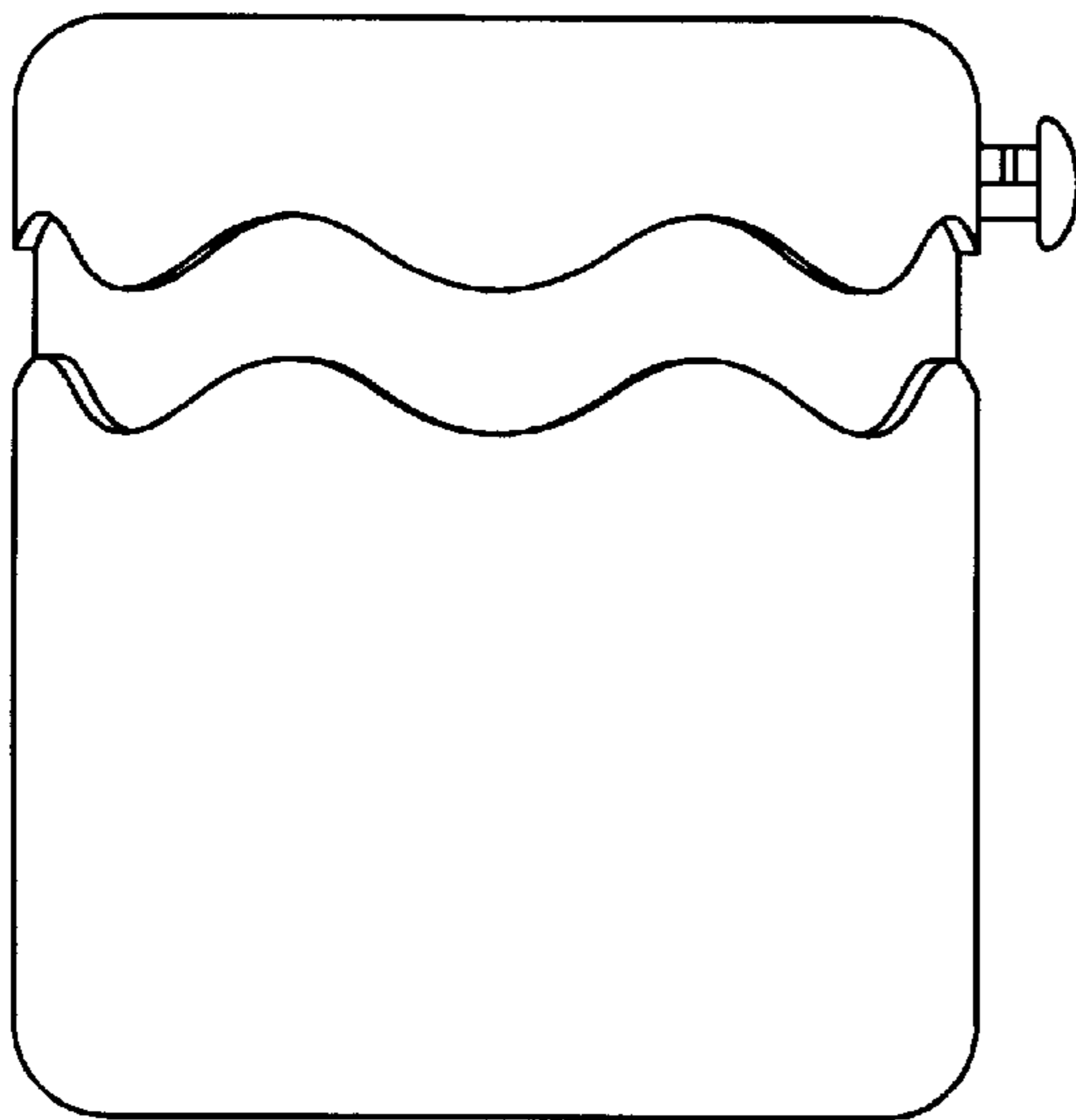

FIG. 11

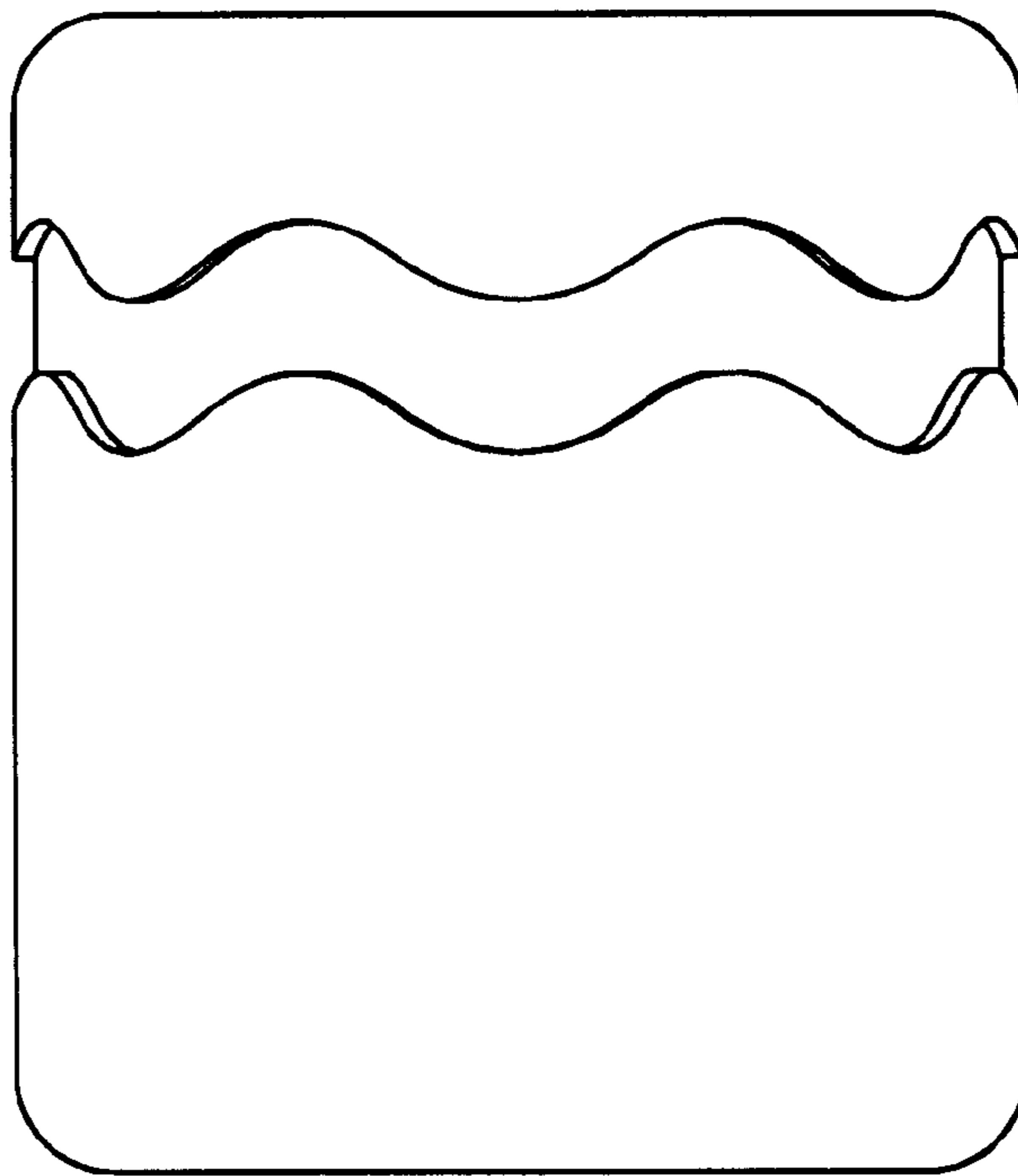

FIG. 12

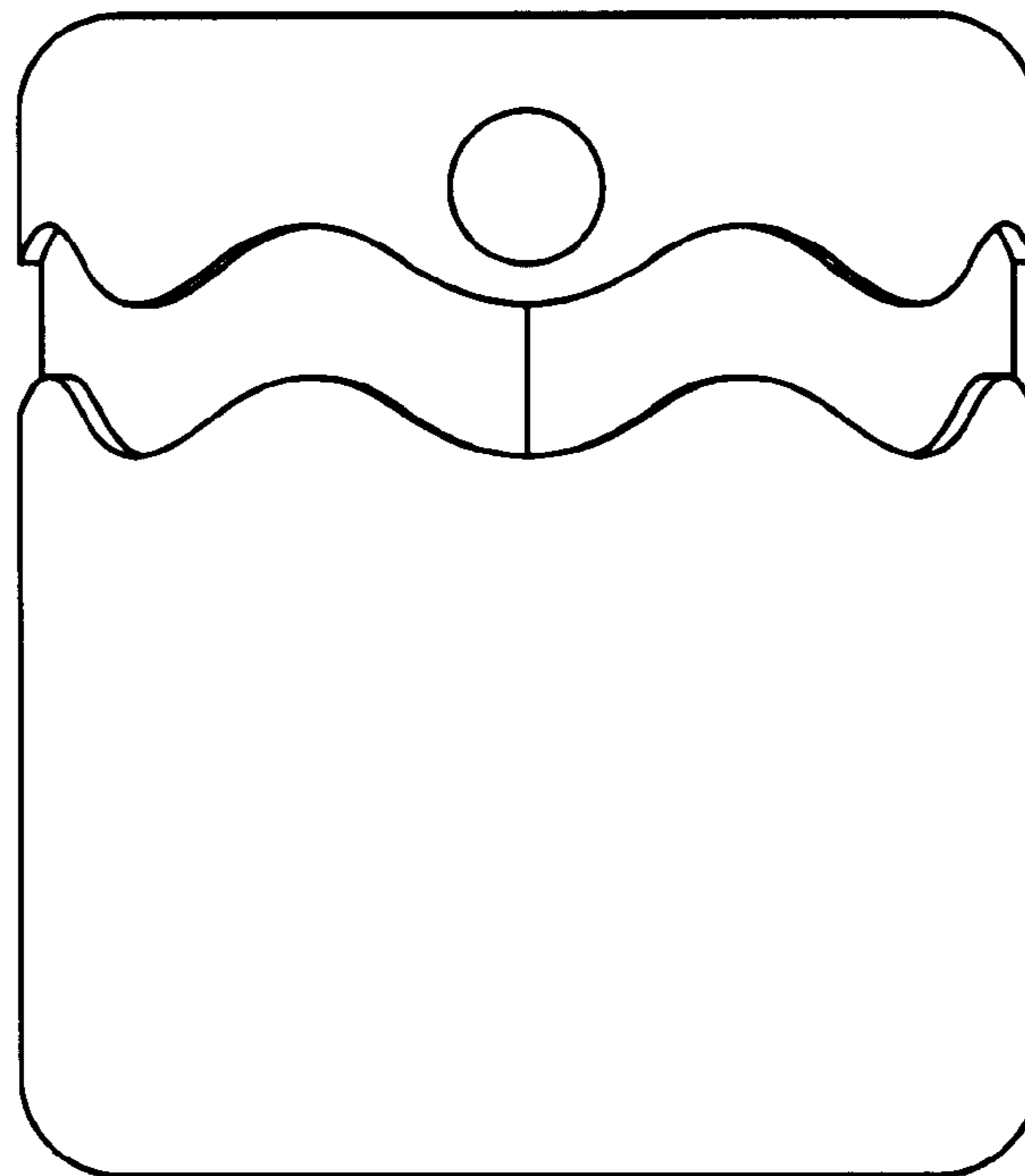

FIG. 13