



US00D429959S

United States Patent [19] Otake

[11] **Patent Number: Des. 429,959**

[45] **Date of Patent: ** Aug. 29, 2000**

[54] **CUP WITH LID**

D. 398,815 9/1998 Hatsumoto et al. D7/533
D. 420,254 2/2000 Park D7/510

[75] Inventor: **Yasuo Otake**, Huntington Beach, Calif.

[73] Assignee: **Nippon Sanso Corporation**, Tokyo, Japan

[**] Term: **14 Years**

Primary Examiner—M. N. Pandozzi
Attorney, Agent, or Firm—Armstrong, Westerman, Hattori, McLeland & Naughton

[21] Appl. No.: **29/115,594**

[22] Filed: **Dec. 20, 1999**

[57] CLAIM

I claim the ornamental design for the cup with lid, as shown and described.

[30] Foreign Application Priority Data

Aug. 9, 1999 [GB] United Kingdom 2085642

[51] **LOC (7) Cl.** **07-01**

[52] **U.S. Cl.** **D7/510; D7/511; D7/533**

[58] **Field of Search** D7/533, 535, 532,
D7/510, 511, 507, 509, 523; 220/703, 719,
715; 215/6, 256, 255, 376, 374; 229/400

DESCRIPTION

FIG. 1 is a perspective view of a cup with lid showing my new design;

FIG. 2 is a front elevational view thereof, the opposite side being a mirror image thereof;

FIG. 3 is a right side elevational view thereof;

FIG. 4 is a left side elevational view thereof;

FIG. 5 is a top plan view thereof;

FIG. 6 is a bottom plan view thereof;

FIG. 7 is a cross-sectional view thereof taken along line 7—7 of FIG. 5; and,

FIG. 8 is a cross-sectional view thereof taken along line 8—8 of FIG. 2.

[56] References Cited

U.S. PATENT DOCUMENTS

D. 231,068 4/1974 Douglas D7/533
D. 386,948 12/1997 Wissinger D7/533
D. 396,777 8/1998 Inoue D7/511

1 Claim, 6 Drawing Sheets

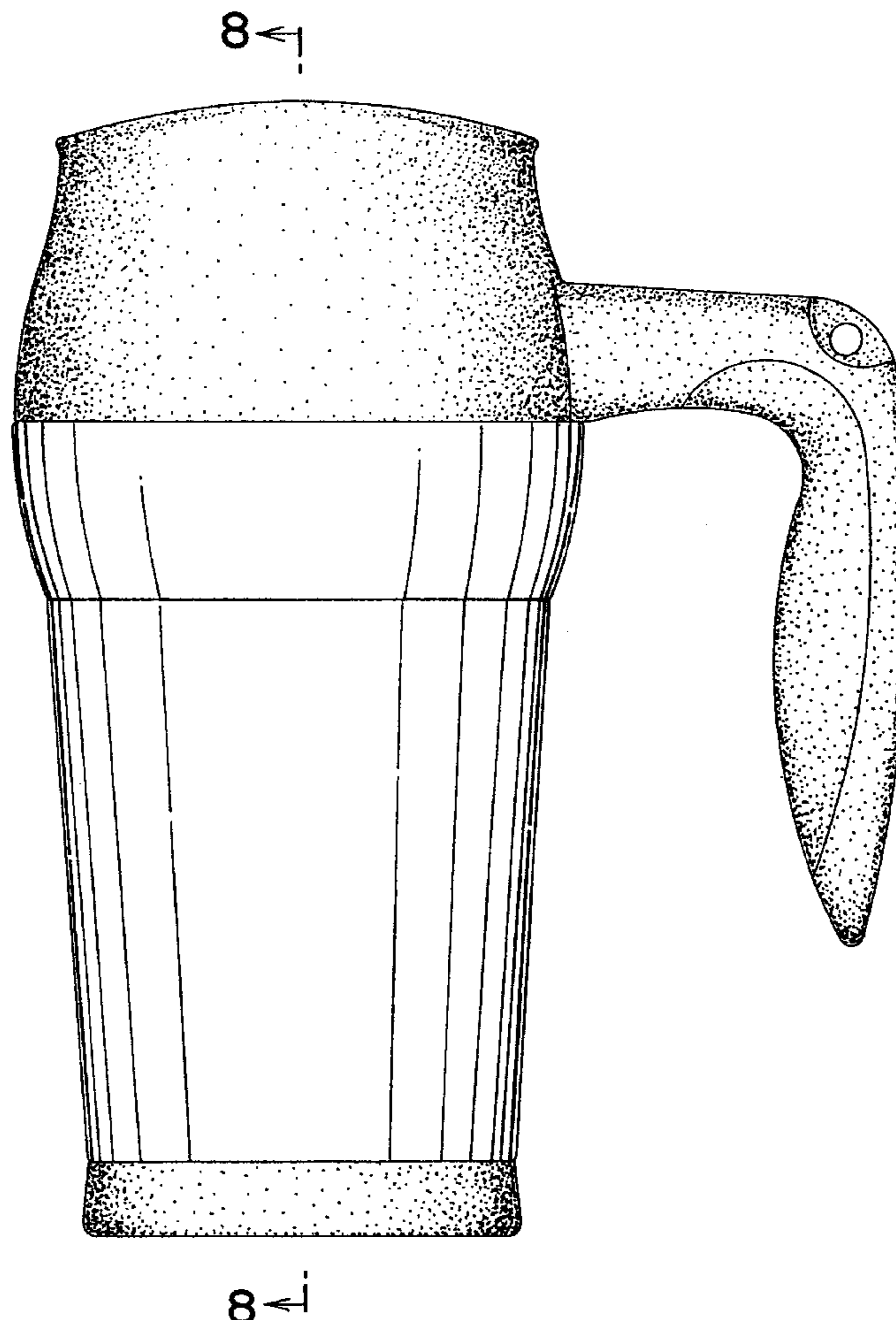

FIG. 1

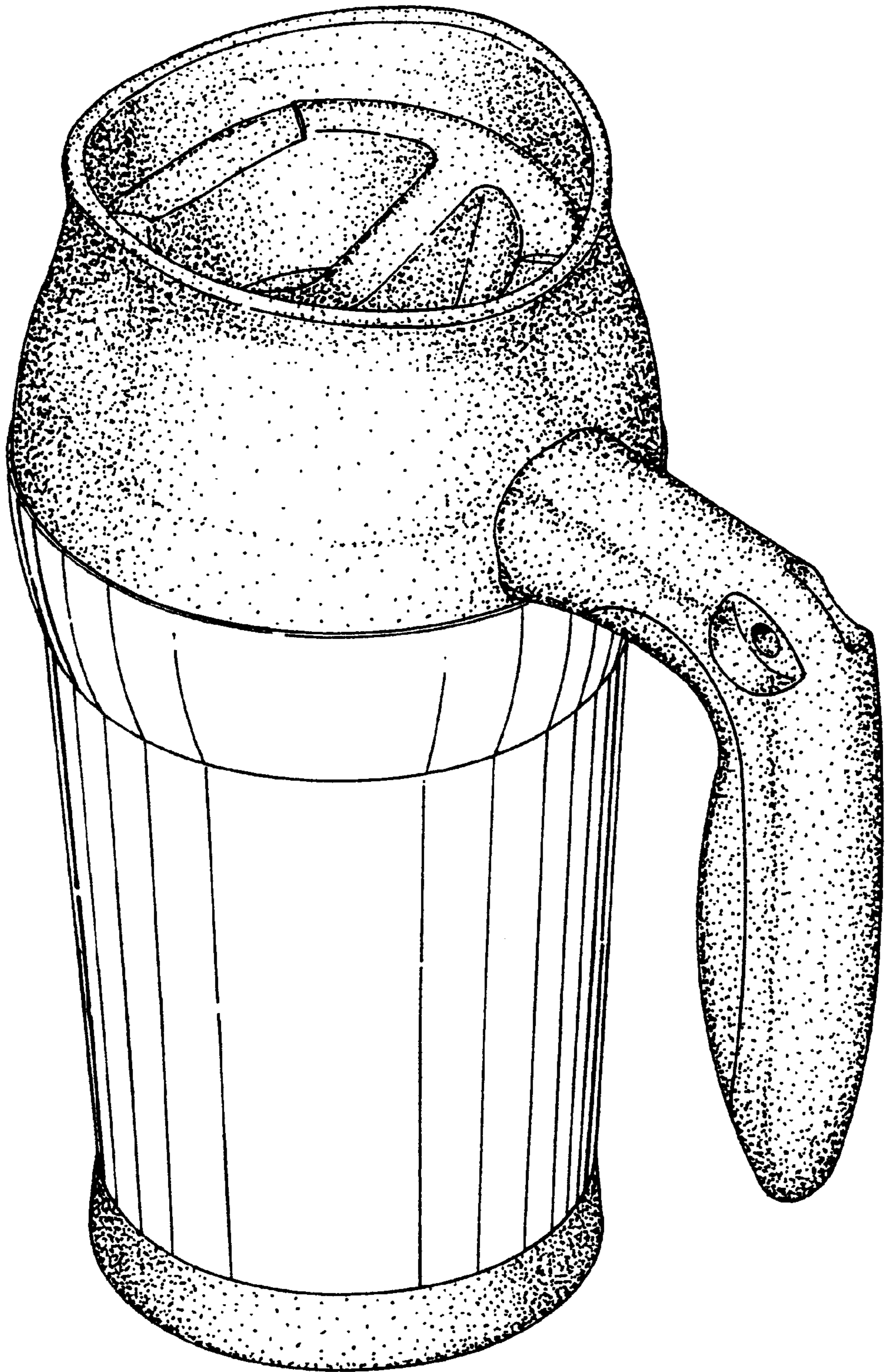

FIG. 2

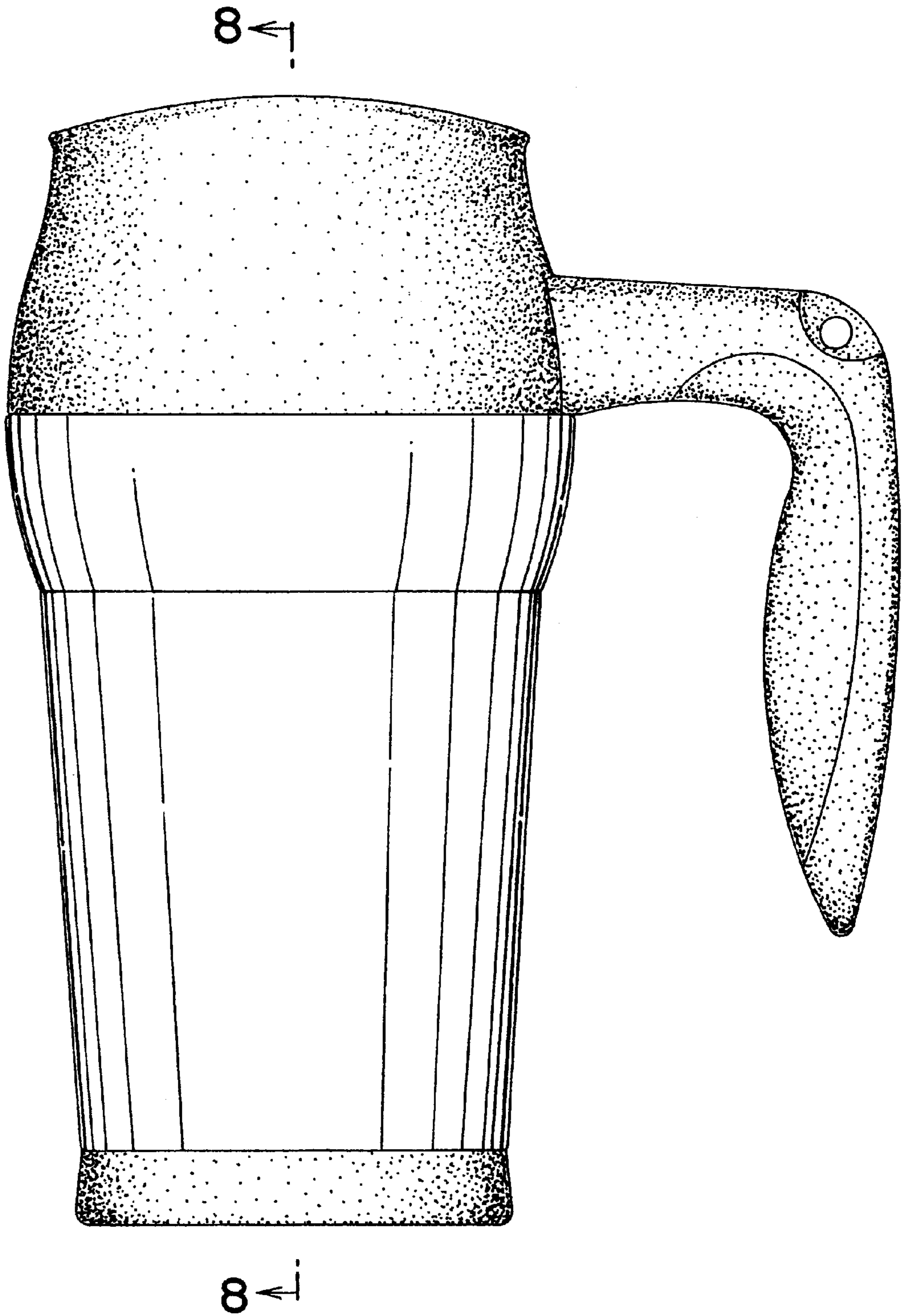

FIG. 4

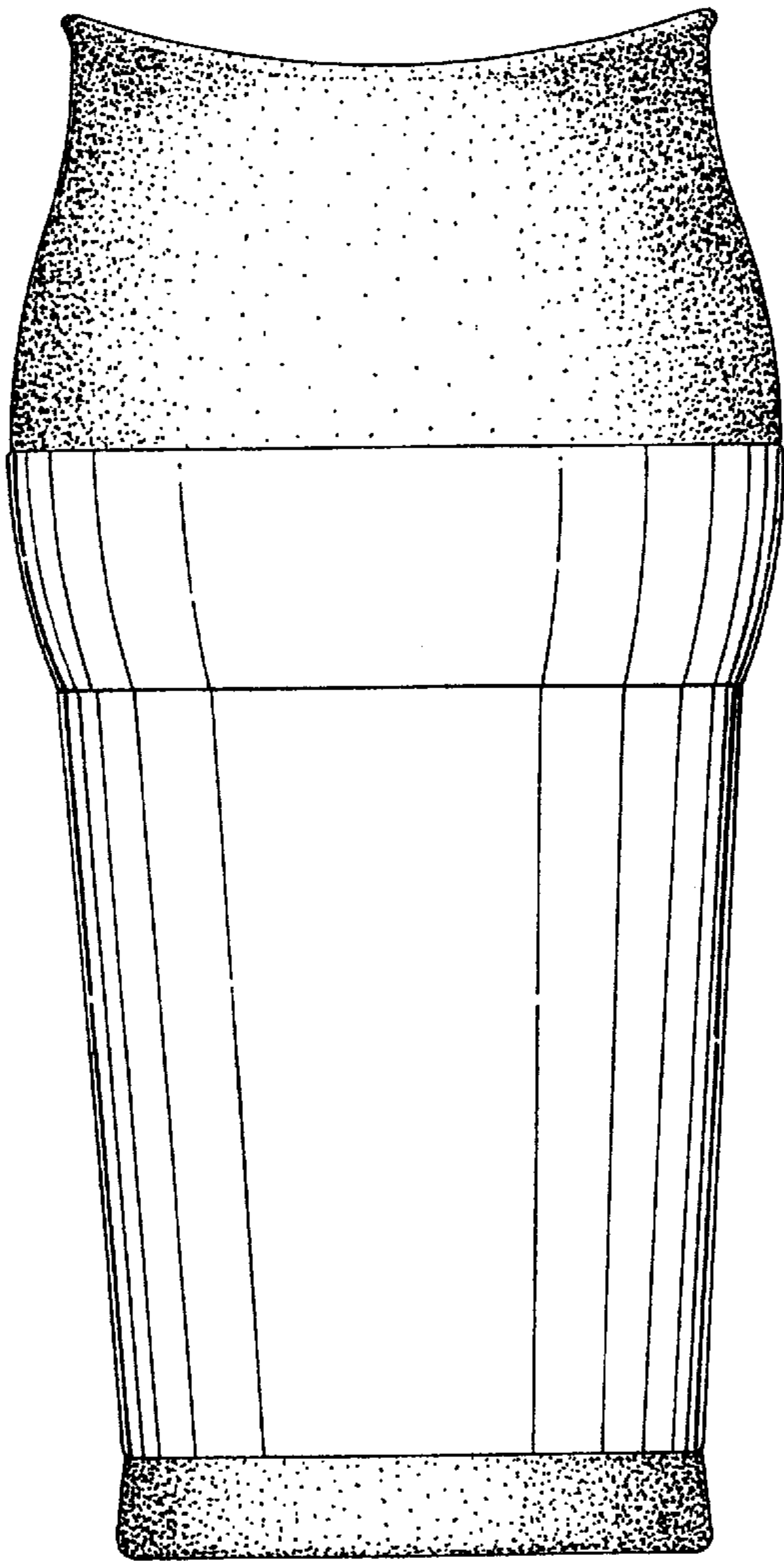

FIG. 3

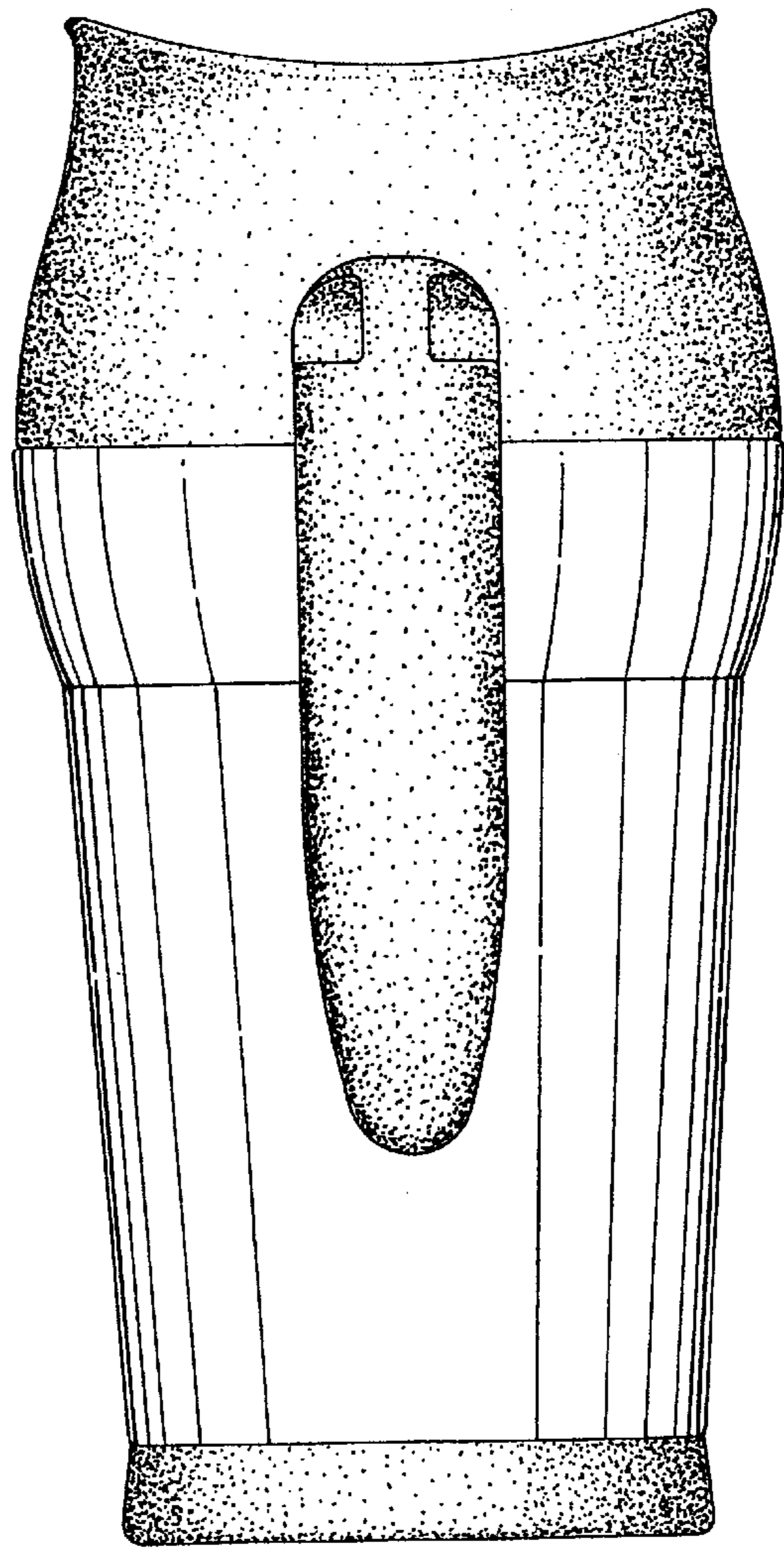

FIG. 5

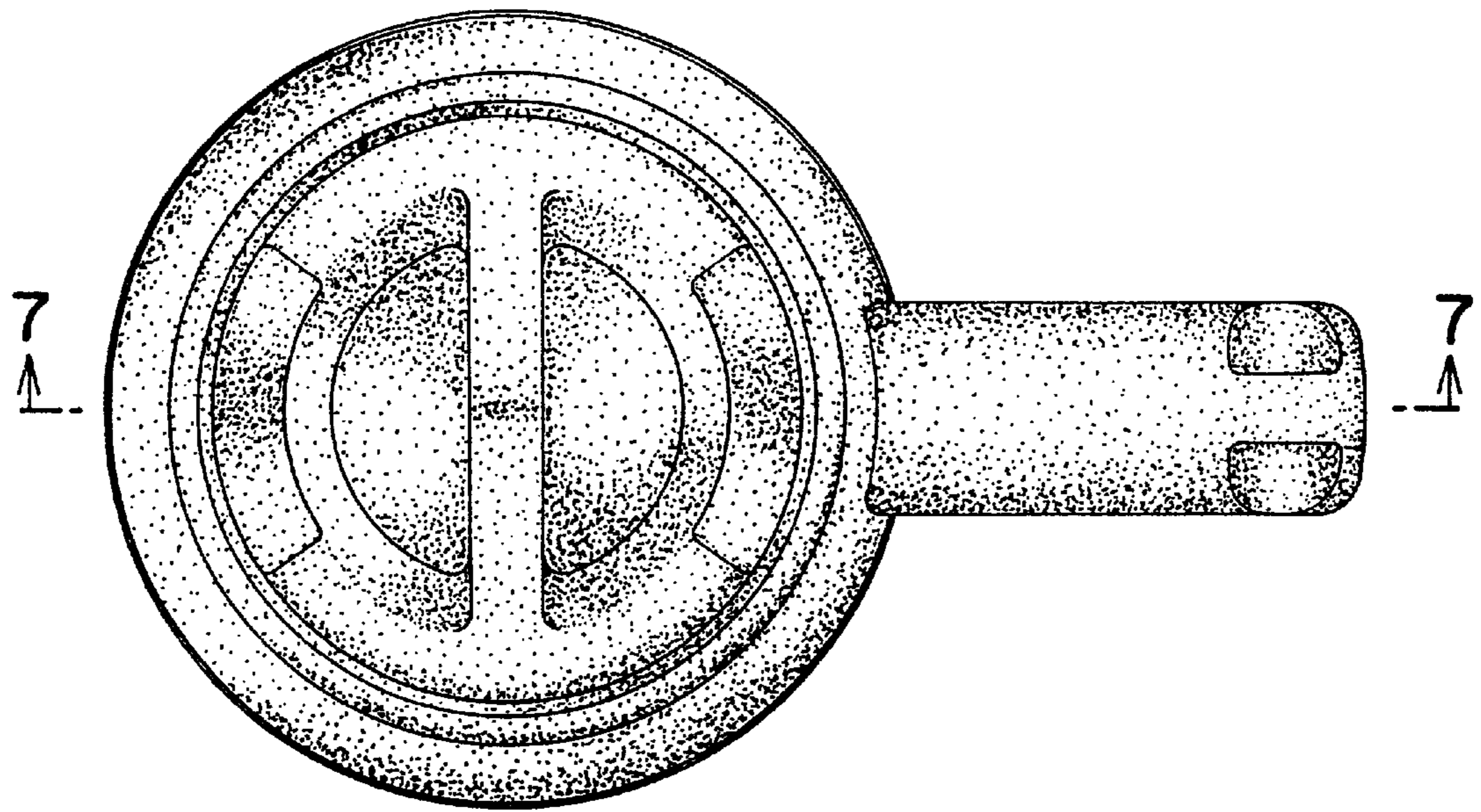

FIG. 6

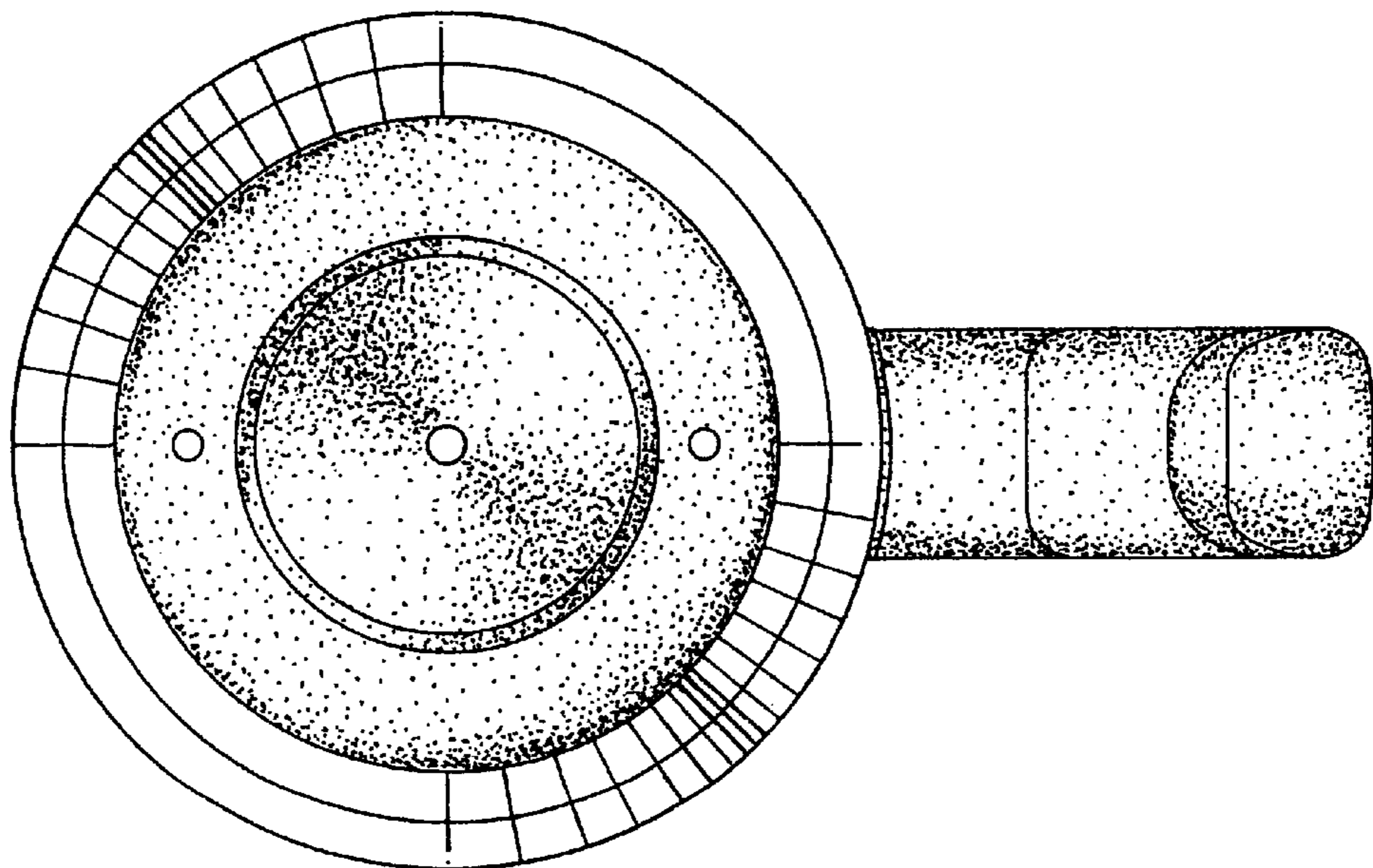

FIG. 7

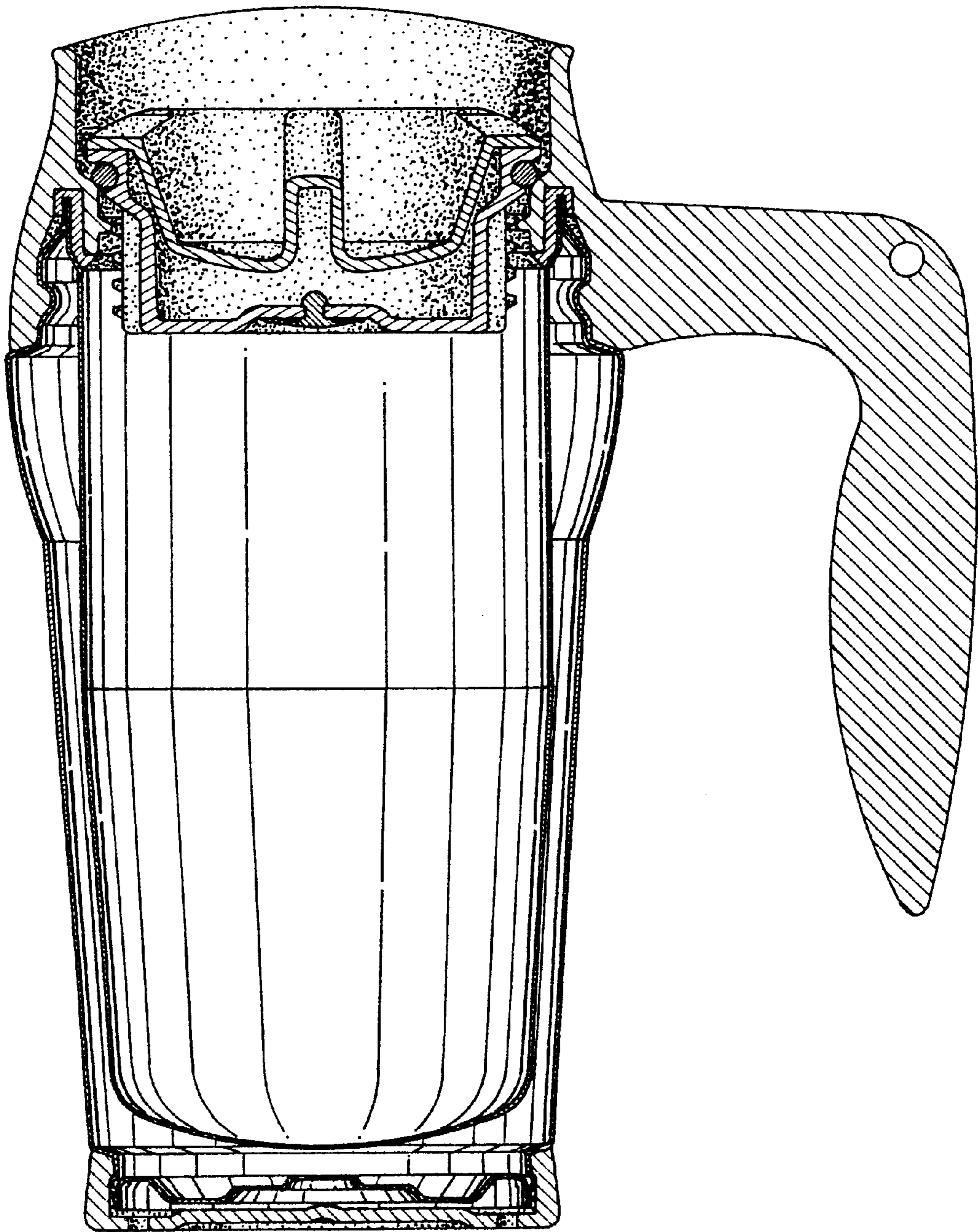

FIG. 8

