



US00D429937S

# United States Patent [19]

[11] Patent Number: Des. 429,937

McCormick et al.

[45] Date of Patent: \*\* Aug. 29, 2000

## [54] ACCESSORY CABINET FOR A BILLIARD CUE RACK

[75] Inventors: William R. McCormick; Kelly M. Wolcott; Theodore J. Caron, all of Kenosha, Wis.

[73] Assignee: Brunswick Bowling & Billiards Corporation, Muskegon, Mich.

[\*\*] Term: 14 Years

[21] Appl. No.: 29/117,914

[22] Filed: Feb. 1, 2000

[51] LOC (7) Cl. .... 08-08

[52] U.S. Cl. .... D6/552

[58] Field of Search ..... D6/552; D21/726, D21/733, 782; 206/579, 315.1; 108/91, 11; 312/107; 211/68

## [56] References Cited

### U.S. PATENT DOCUMENTS

D. 335,416 5/1993 Shaw ..... D6/552  
4,262,605 4/1981 Sokol ..... 312/107 X

Primary Examiner—Brian N. Vinson  
Attorney, Agent, or Firm—Price, Heneveld, Cooper, DeWitt & Litton

## [57] CLAIM

We claim the ornamental design for an accessory cabinet for a billiard cue rack, as shown and described.

### DESCRIPTION

FIG. 1 is a front elevational view of a billiard cue rack incorporating the accessory cabinet of the present invention; FIG. 2 is a perspective view showing the top, left side, and inside of the inventive accessory cabinet with the door of the cabinet in an open position; FIG. 3 is a front elevational view of the accessory cabinet with the door closed; FIG. 4 is a side elevational view of the right side of the accessory cabinet of the present invention with the door in the closed position; FIG. 5 is the side elevational view of the left side of the accessory cabinet of the present invention with the door in the closed position; and, FIG. 6 is a top perspective view of the accessory cabinet design of the present invention.

As illustrated in FIG. 1, the accessory cabinet design of the present invention is intended to be incorporated into a billiard cue rack. The billiard cue rack may take any form and hence the details of the billiard cue rack are shown in phantom and do not form a part of the design sought to be patented. As shown in FIG. 2, the accessory cabinet is intended to provide a location for storage of cue chalk, table brushes, etc. that do not themselves form a portion of the design sought to be patented. The rear and bottom views of the accessory cabinet of the present invention are not ornamented and do not form a part of the design sought to be patented.

1 Claim, 3 Drawing Sheets

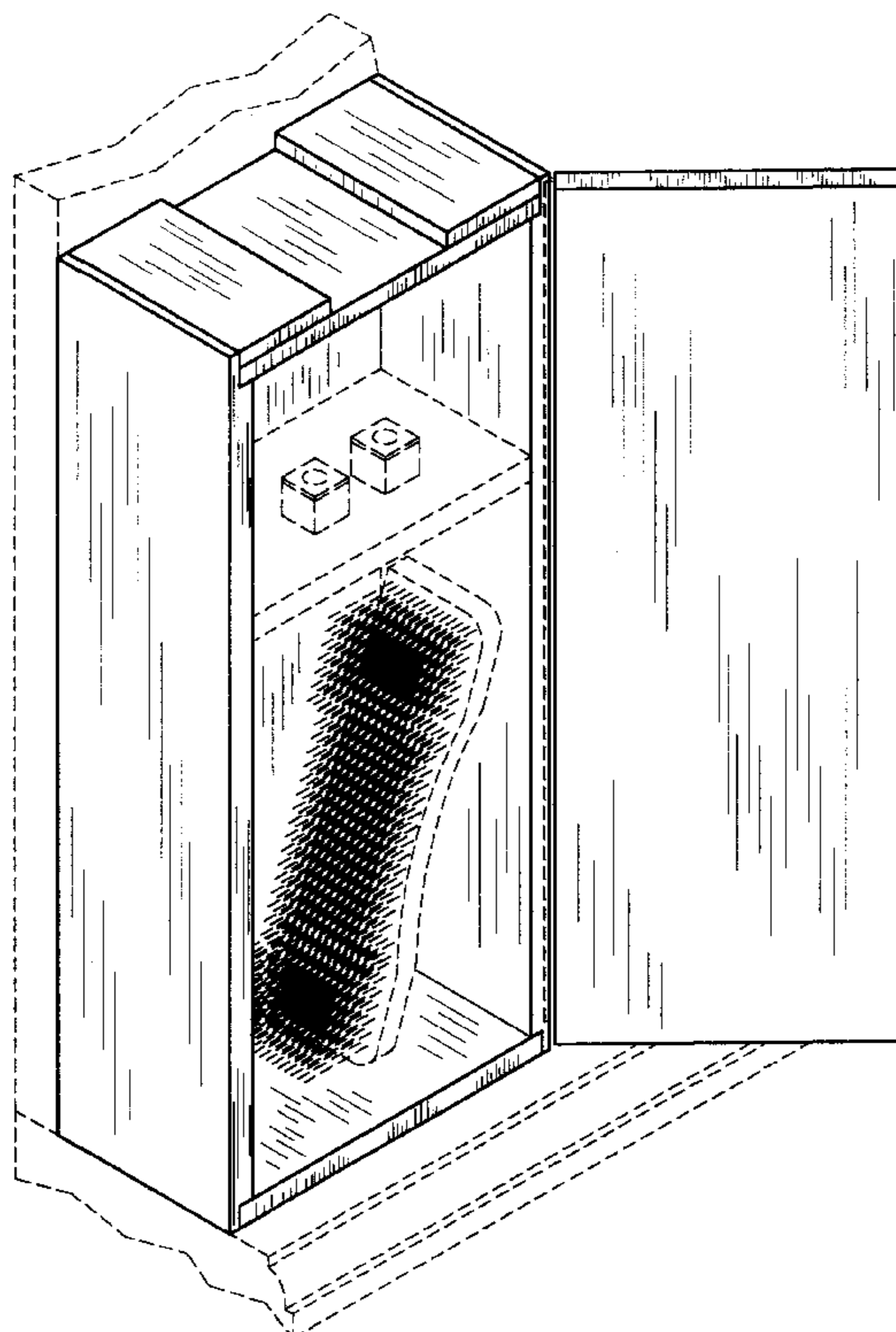

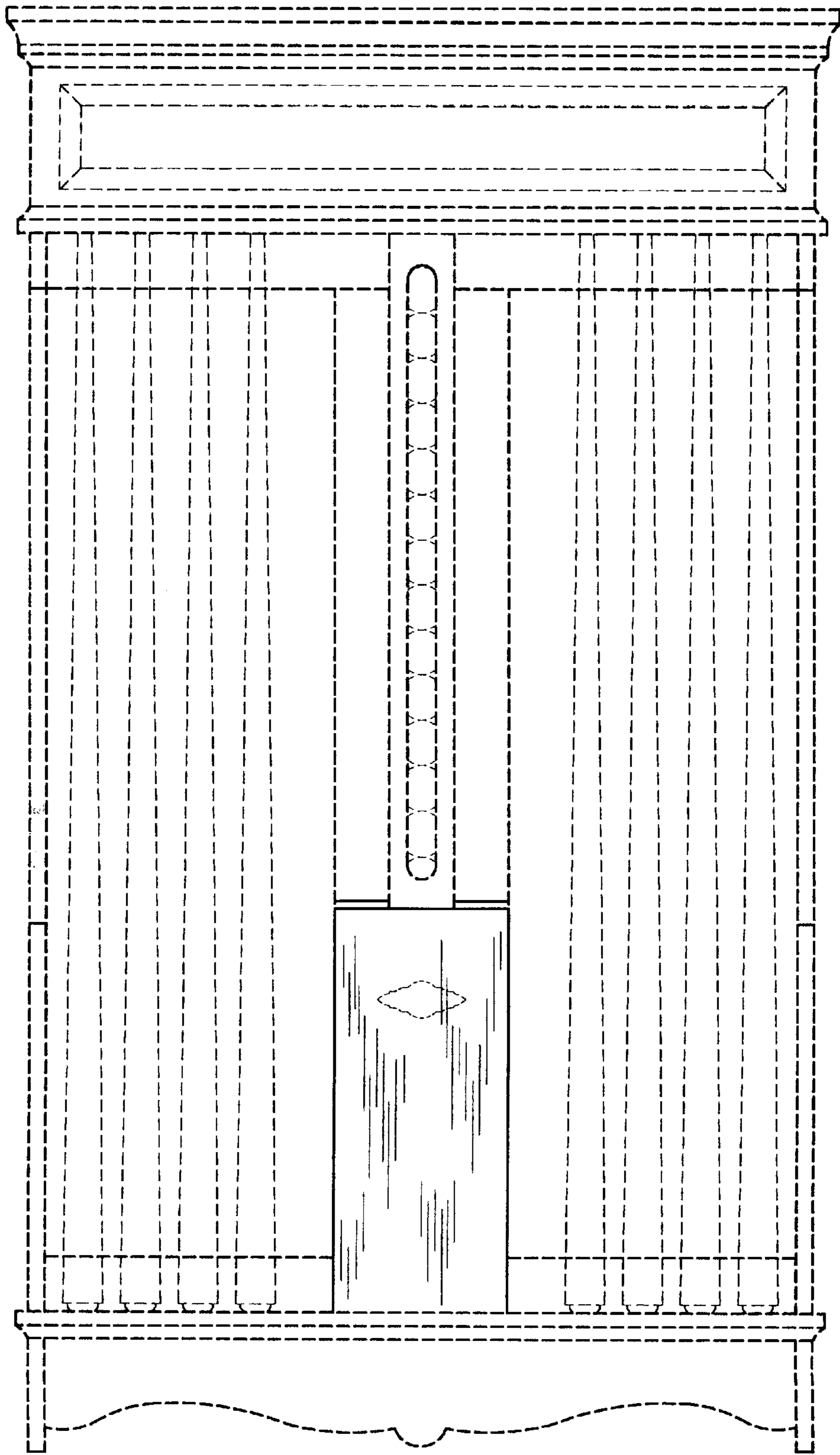

FIG. 1

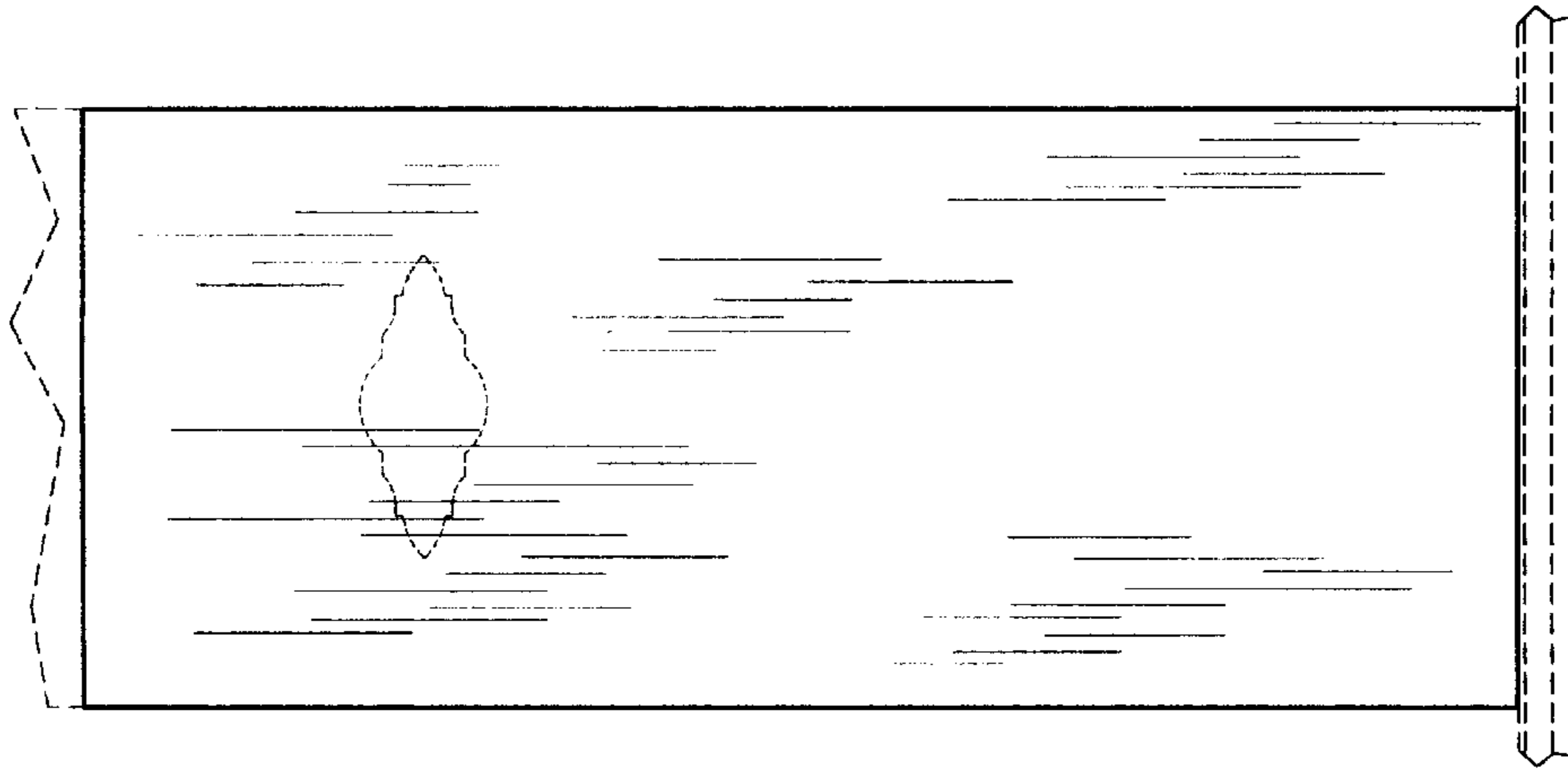

FIG. 3

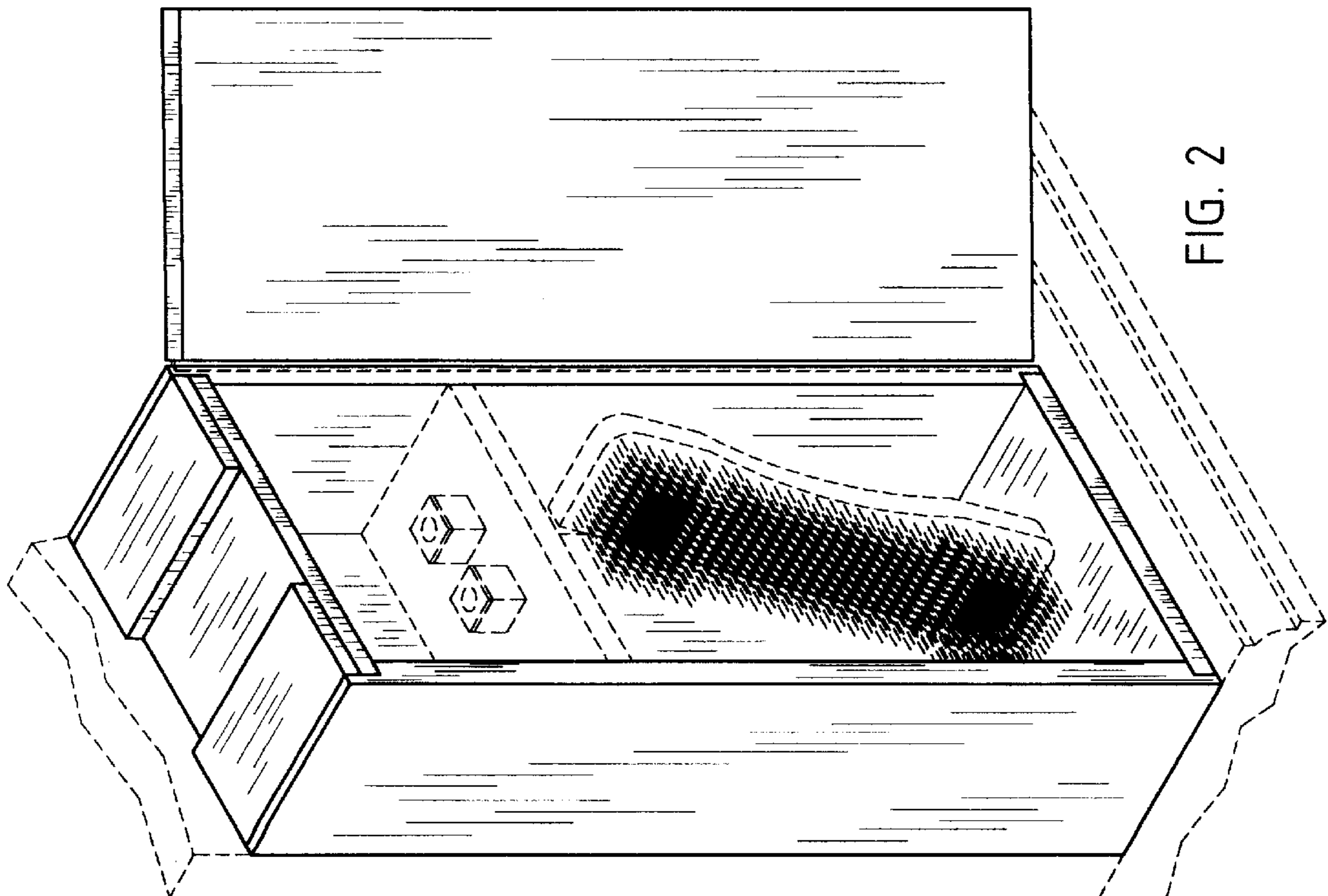

FIG. 2

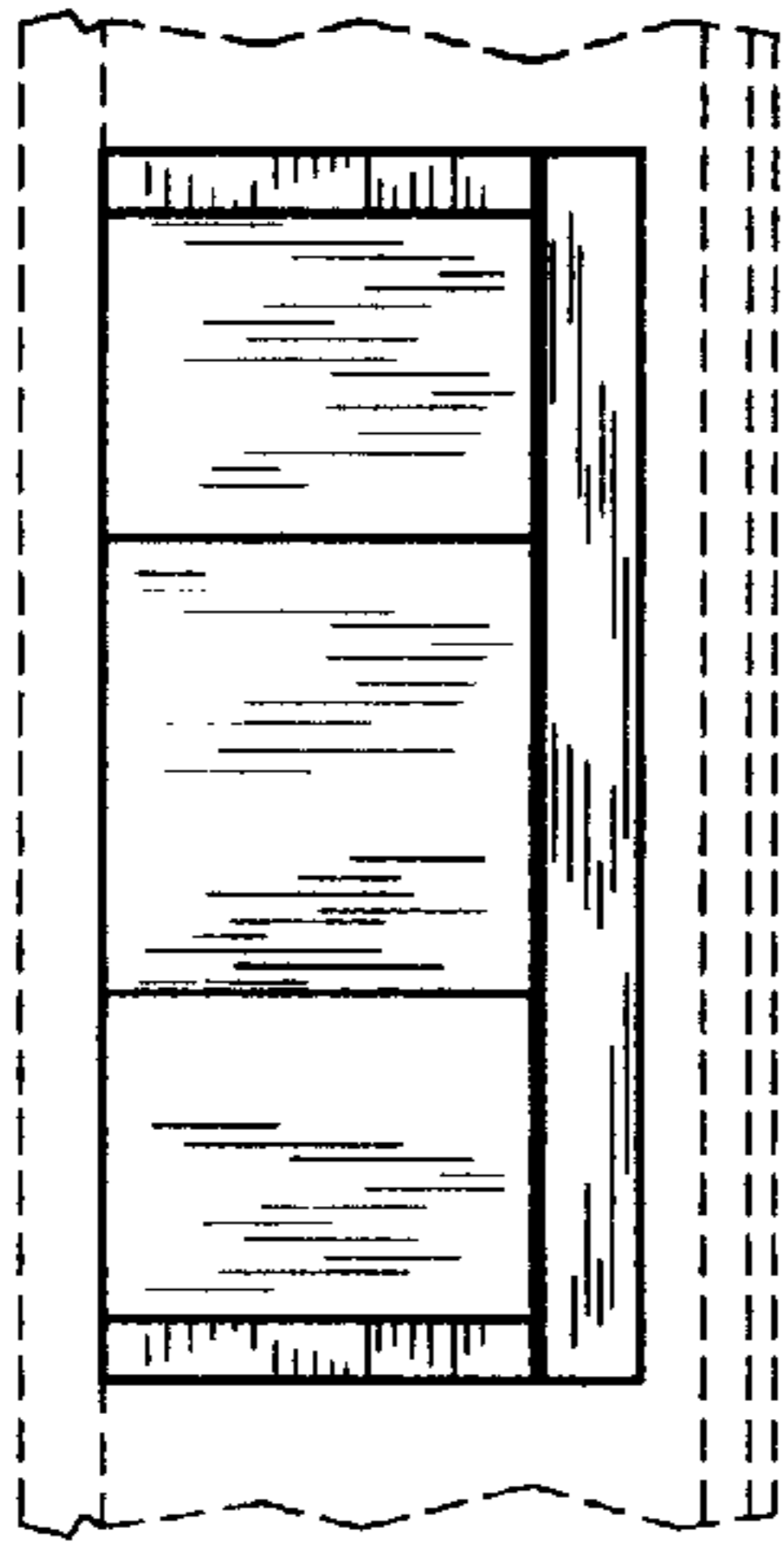

FIG. 6

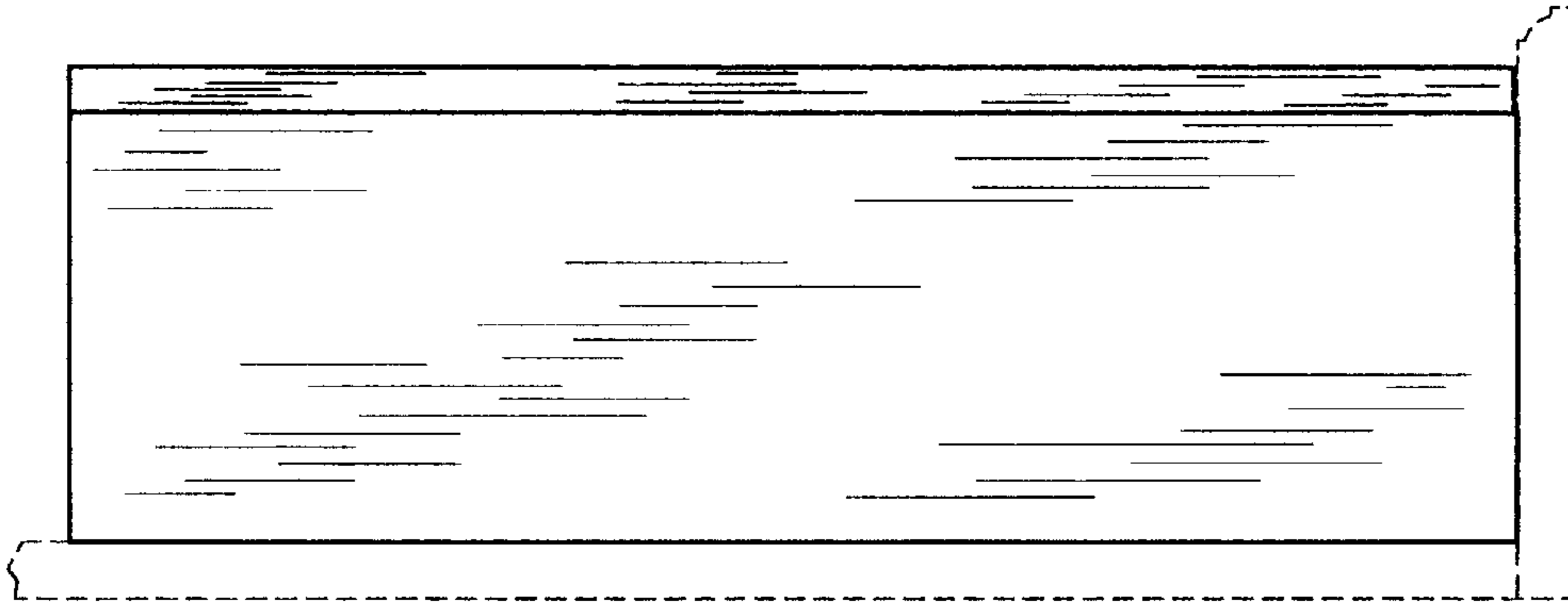

FIG. 5

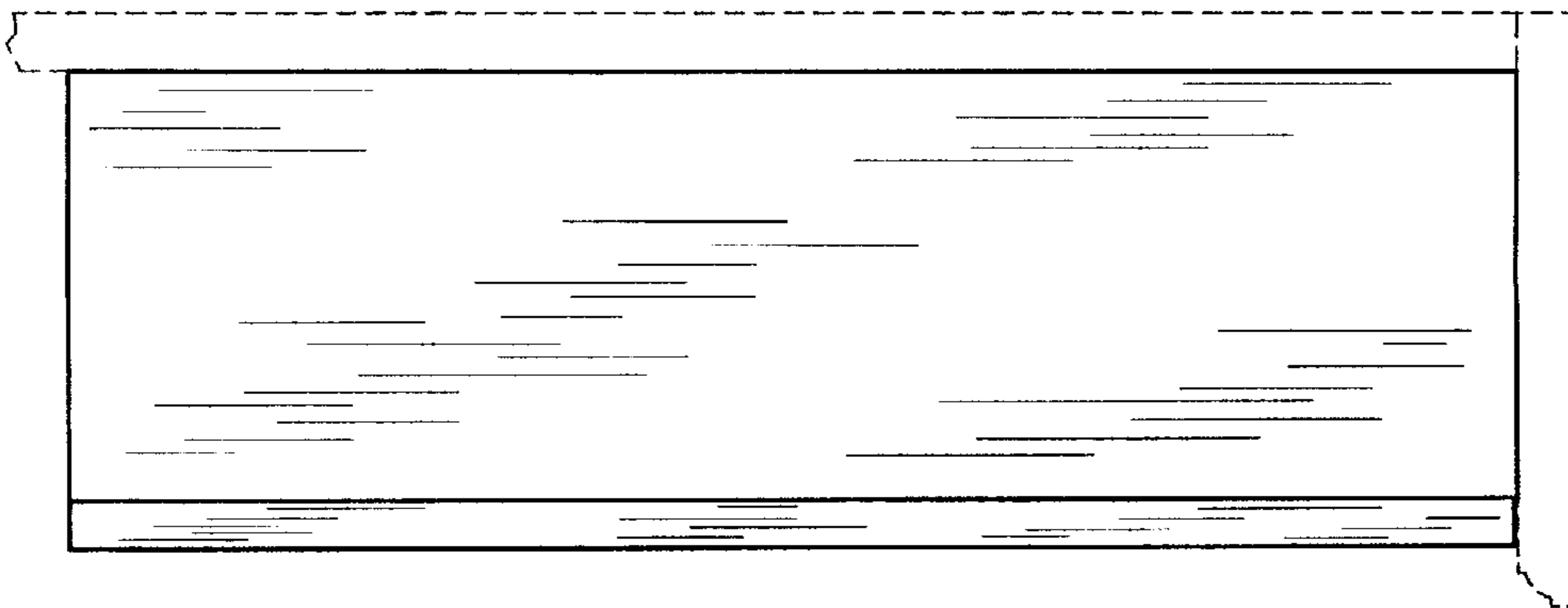

FIG. 4