



US00D429855S

United States Patent [19] Griffin

[11] Patent Number: Des. 429,855

[45] Date of Patent: ** Aug. 22, 2000

[54] VACUUM CLEANER

[75] Inventor: John Griffin, Phoenix, Ariz.

[73] Assignee: Shop Vac Corporation, Williamsport, Pa.

[**] Term: 14 Years

[21] Appl. No.: 29/097,419

[22] Filed: Dec. 7, 1998

[51] LOC (7) Cl. 15-05

[52] U.S. Cl. D32/23

[58] Field of Search D32/21, 23-25,
D32/31; 15/327.1, 327.2, 327.4, 320-321,
323, 352, 353, 347, 328

[56] **References Cited**

U.S. PATENT DOCUMENTS

D. 287,171	12/1986	Berfield et al.	D32/25
D. 315,624	3/1991	Kimura et al.	D32/23
D. 357,336	4/1995	Moine et al.	D32/23
D. 357,773	4/1995	Wareham et al.	D32/23
D. 358,010	5/1995	Berfield et al.	D32/23
D. 361,179	8/1995	Moine et al.	D32/23
D. 362,091	9/1995	Tomasiak et al.	D32/23
D. 372,567	8/1996	Moine et al.	D32/23
D. 373,862	9/1996	Stephens et al.	D32/23
D. 383,575	9/1997	Griffin	D32/23
D. 384,448	9/1997	Stephens et al.	D32/23
D. 388,565	12/1997	Pietrobon	D32/23
D. 389,962	1/1998	Berfield et al.	D32/23
D. 395,119	6/1998	Berfield	D34/23
2,920,337	1/1960	Smith	15/323
5,144,716	9/1992	Watanabe et al.	15/323

OTHER PUBLICATIONS

SHOP-VAC Brochure, 707 Series Super Performance Wet/Dry Vacs, Model No. 707-10, dated Mar. 1991.

SHOP-VAC Brochure, QSP Series—Quiet Super Power Wet/Dry Vacs, Models 900-86 and 900-87, dated Aug. 1993.

SHOP-VAC Brochure, QSP Series—Quiet Super Power Wet/Dry Vacs, Model No. 900-29, dated Aug. 1993.

SHOP-VAC Brochure, Series 914—Quiet Super Performance Wet/Dry Vacs, Model Nos. 914-15 and 914-27, dated Apr. 1997.

SHOP-VAC Brochure, FLOORMASTER, Wet & Dry Cleaning System, Model No. 909-50, dated Jan. 1989.

SHOP-VAC Brochure, The QSP Line of Wet/Dry Vacs from Shop Vac, dated 1994.

SHOP-VAC Brochure, ALL AROUND Vac, dated 1997.

SHOP-VAC Brochure, QSP PRO, dated 1998.

SHOP-VAC Brochure, QPV, dated 1997.

SHOP-VAC Brochure, 1X1 Wet/Dry Vac, dated 1997.

Karcher Brochure, High Performance Wet and Dry Vacuums, Dust Extraction and Spray Extraction Machines.

Primary Examiner—Ruth McInroy

Attorney, Agent, or Firm—Marshall, O’Toole, Gerstein, Murray & Borun

[57] **CLAIM**

The ornamental design for a vacuum cleaner, as shown and described.

DESCRIPTION

FIG. 1 is a perspective view of a vacuum cleaner showing my new design;

FIG. 2 is a front elevational view thereof;

FIG. 3 is a back elevational view thereof;

FIG. 4 is a left elevational view thereof;

FIG. 5 is a right elevational view thereof;

FIG. 6 is a plan view thereof; and,

FIG. 7 is a bottom view thereof.

1 Claim, 7 Drawing Sheets

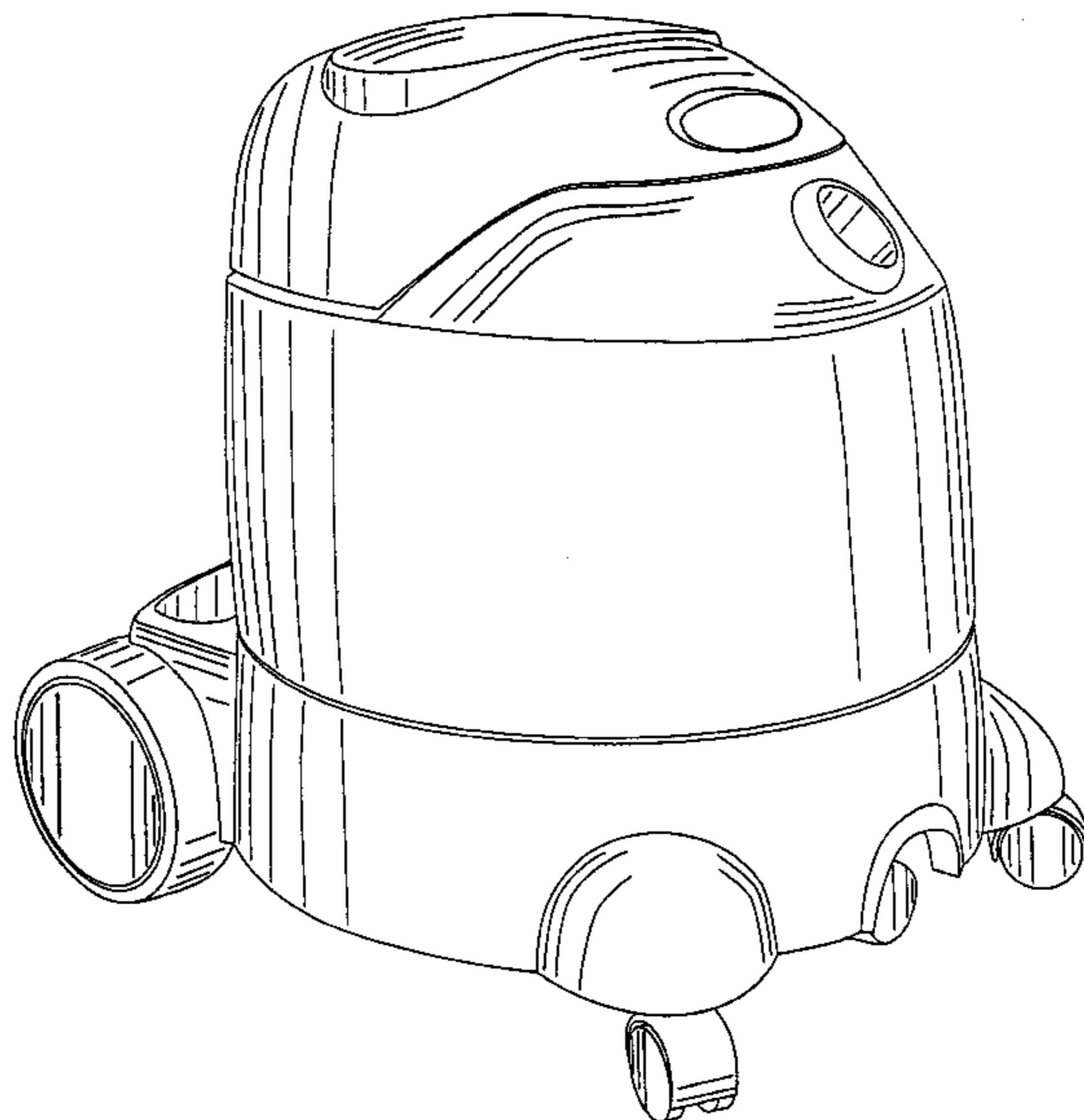

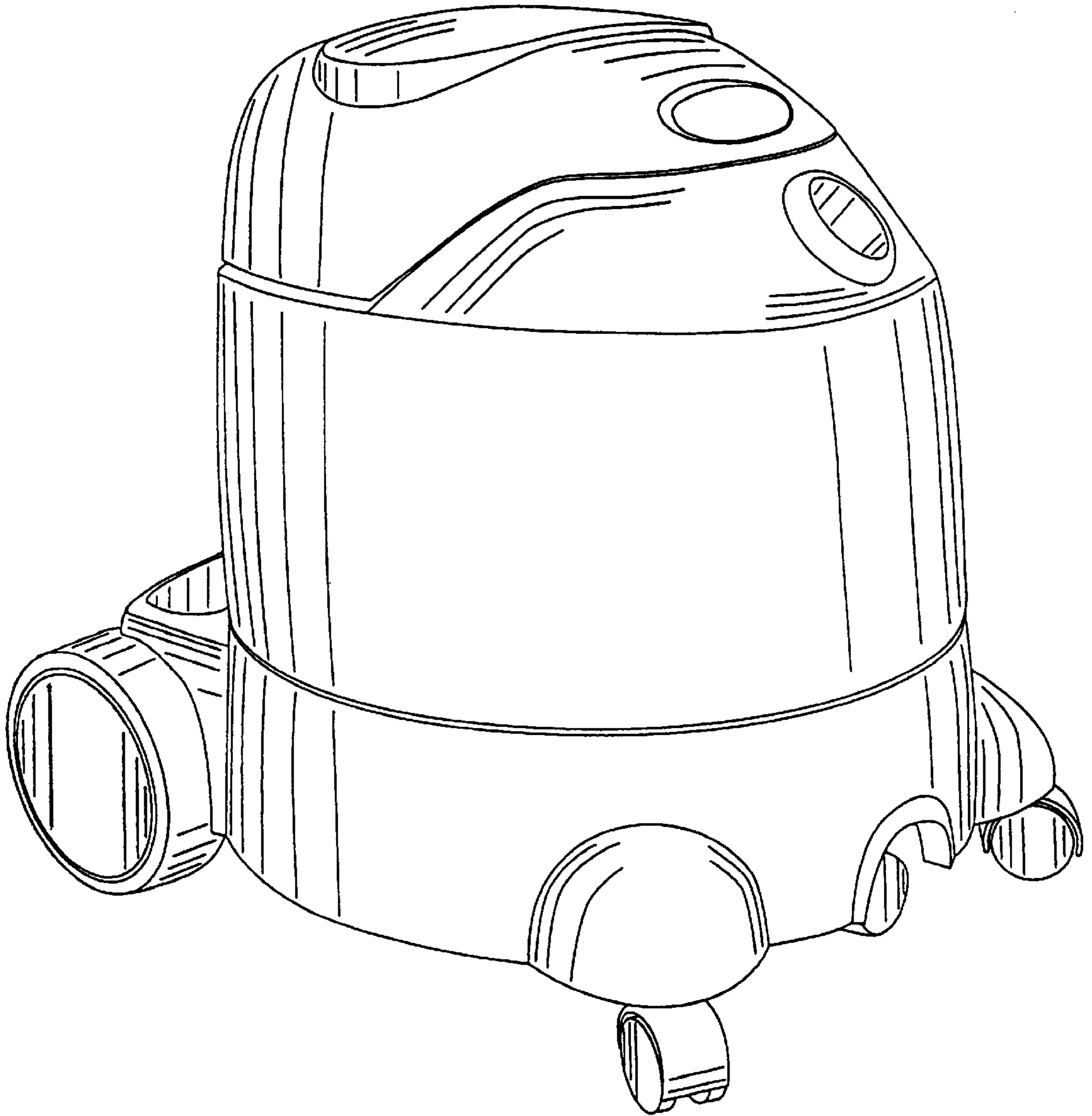

FIG. 1

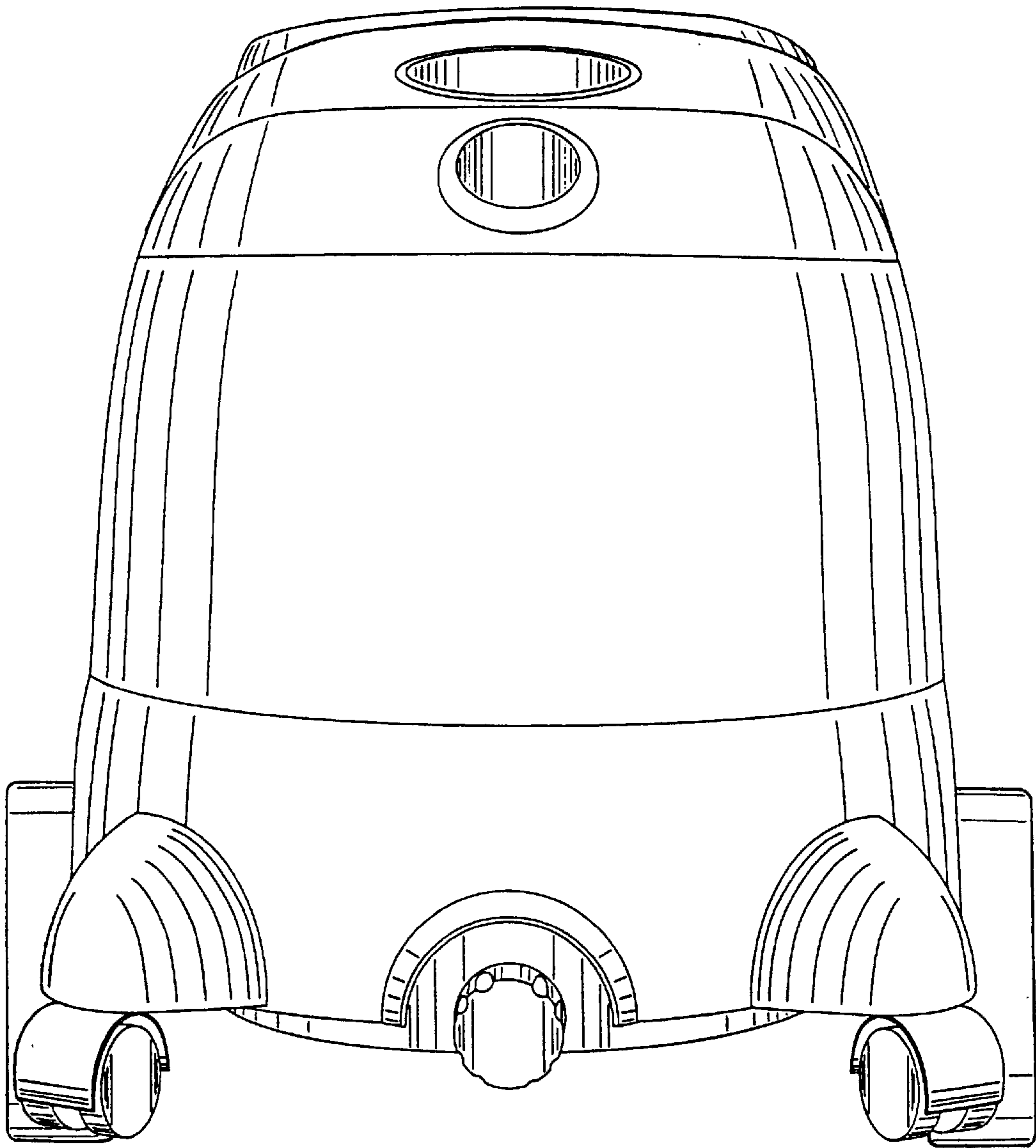

FIG. 2

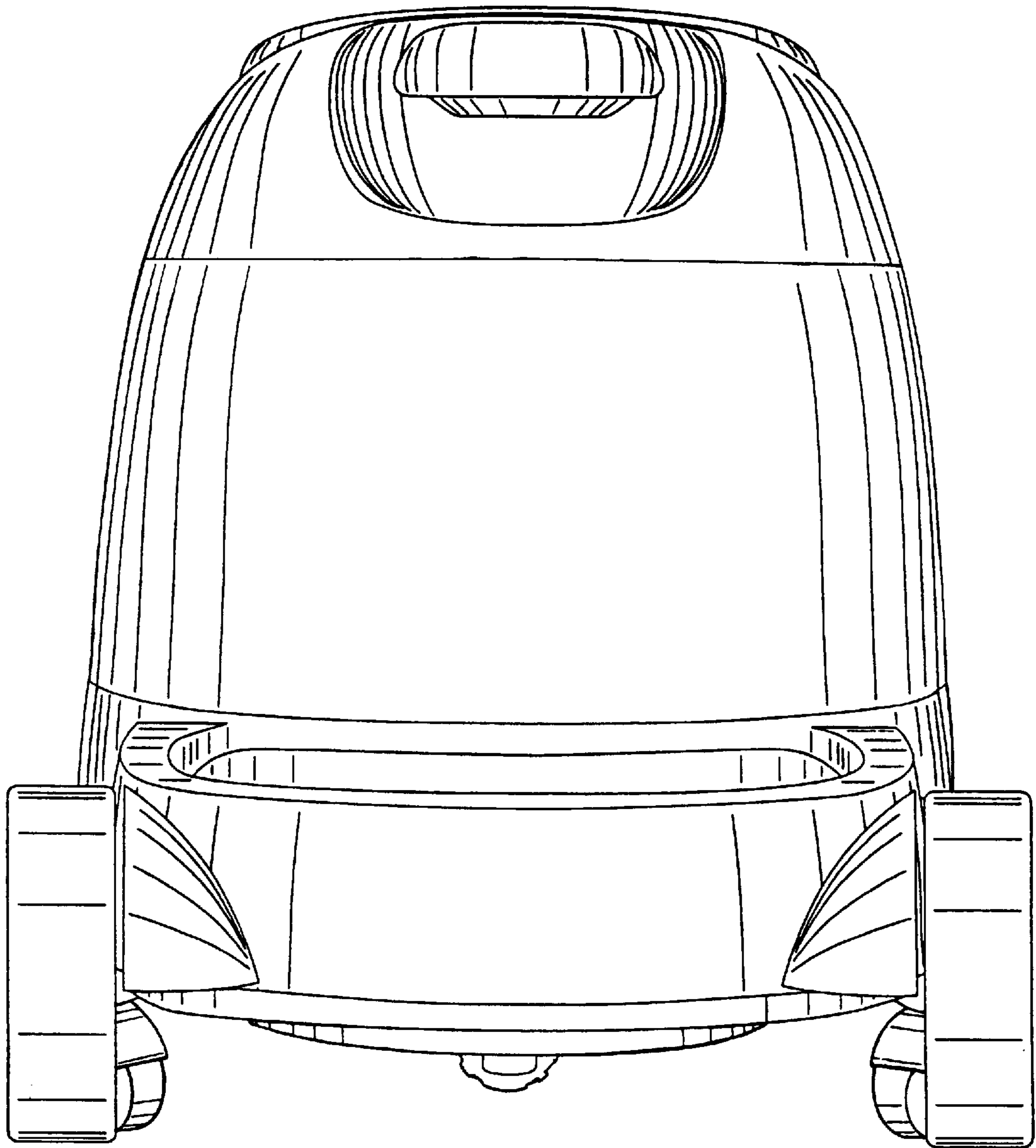

FIG. 3

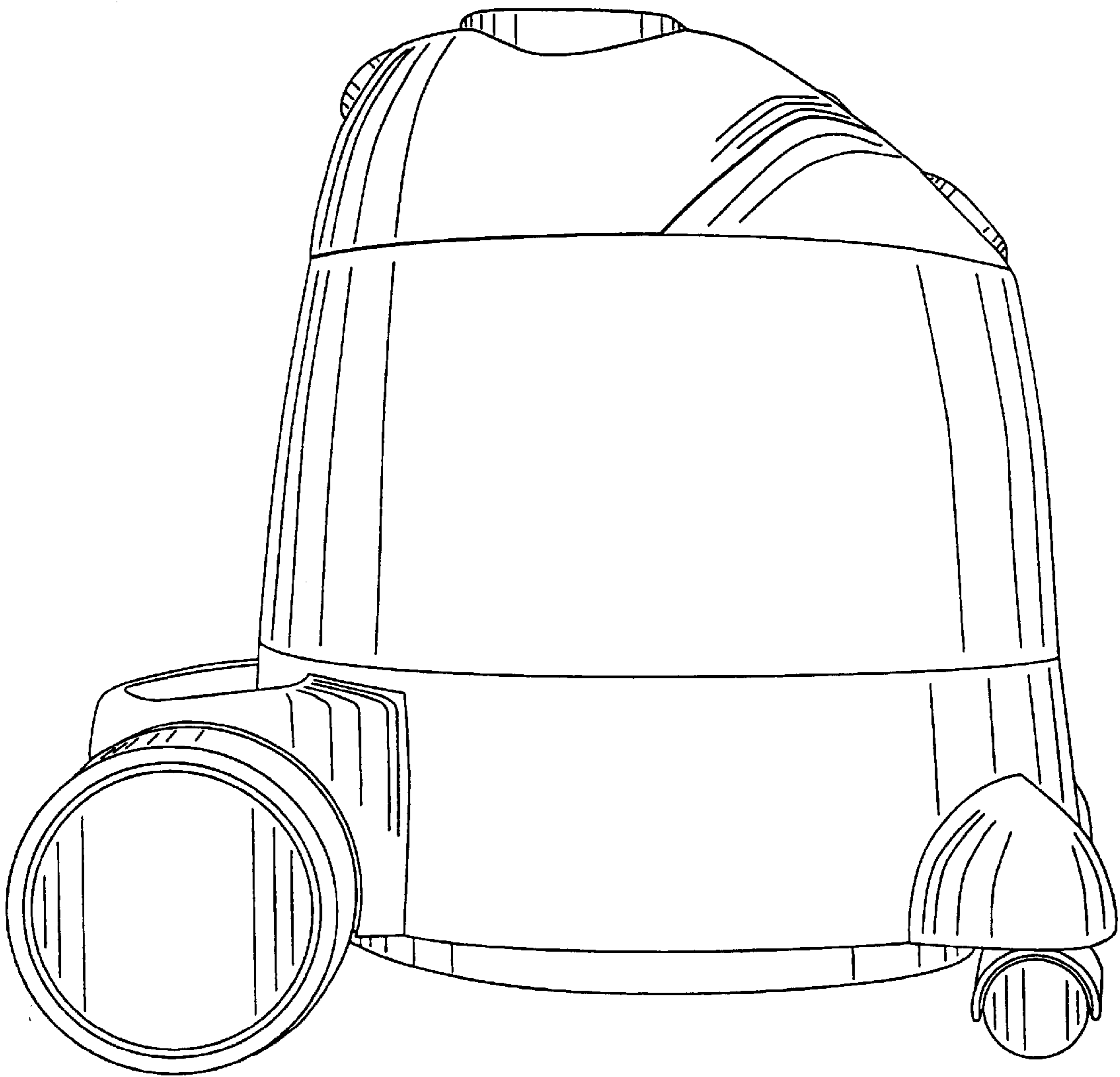

FIG. 4

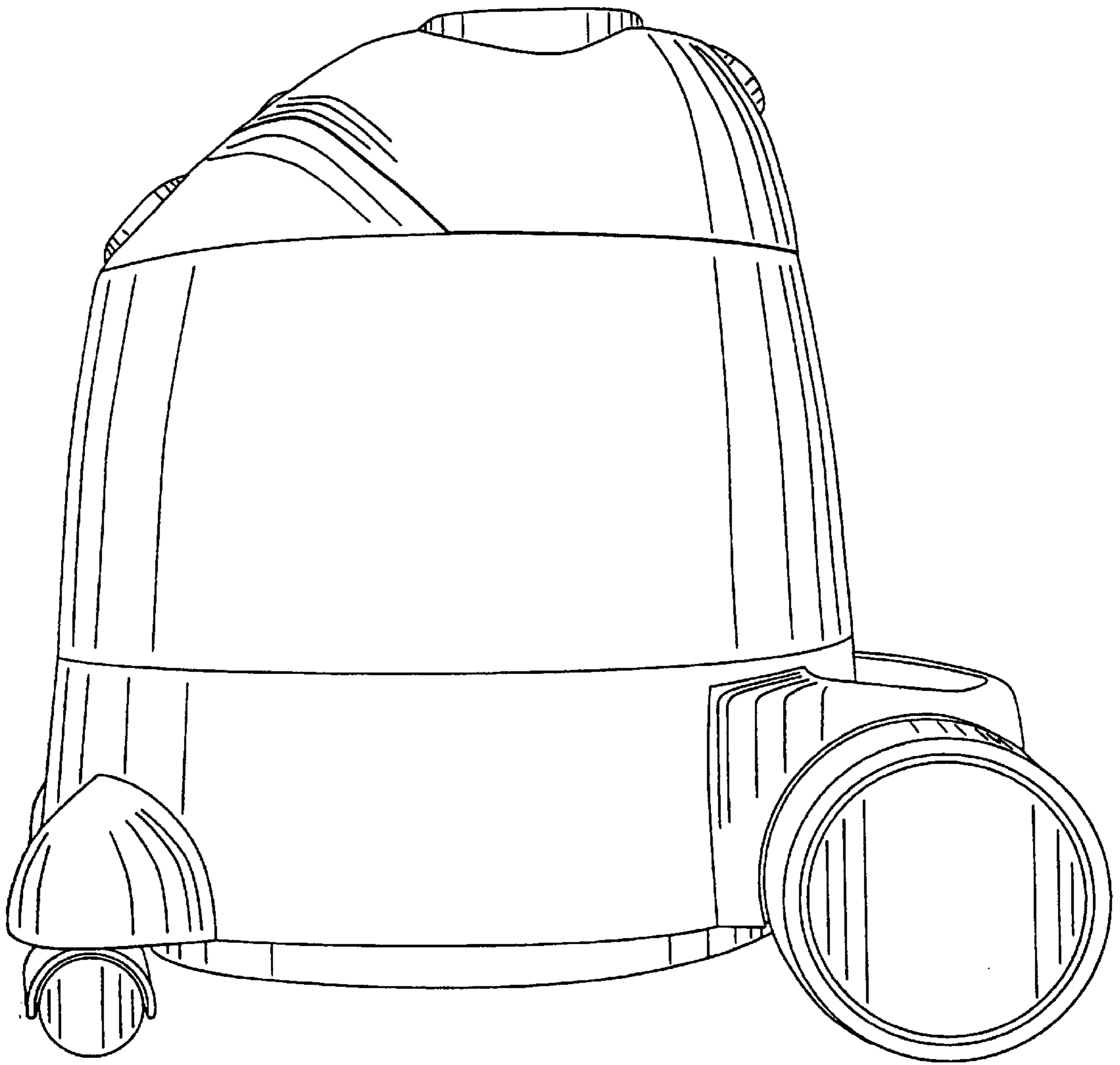

FIG. 5

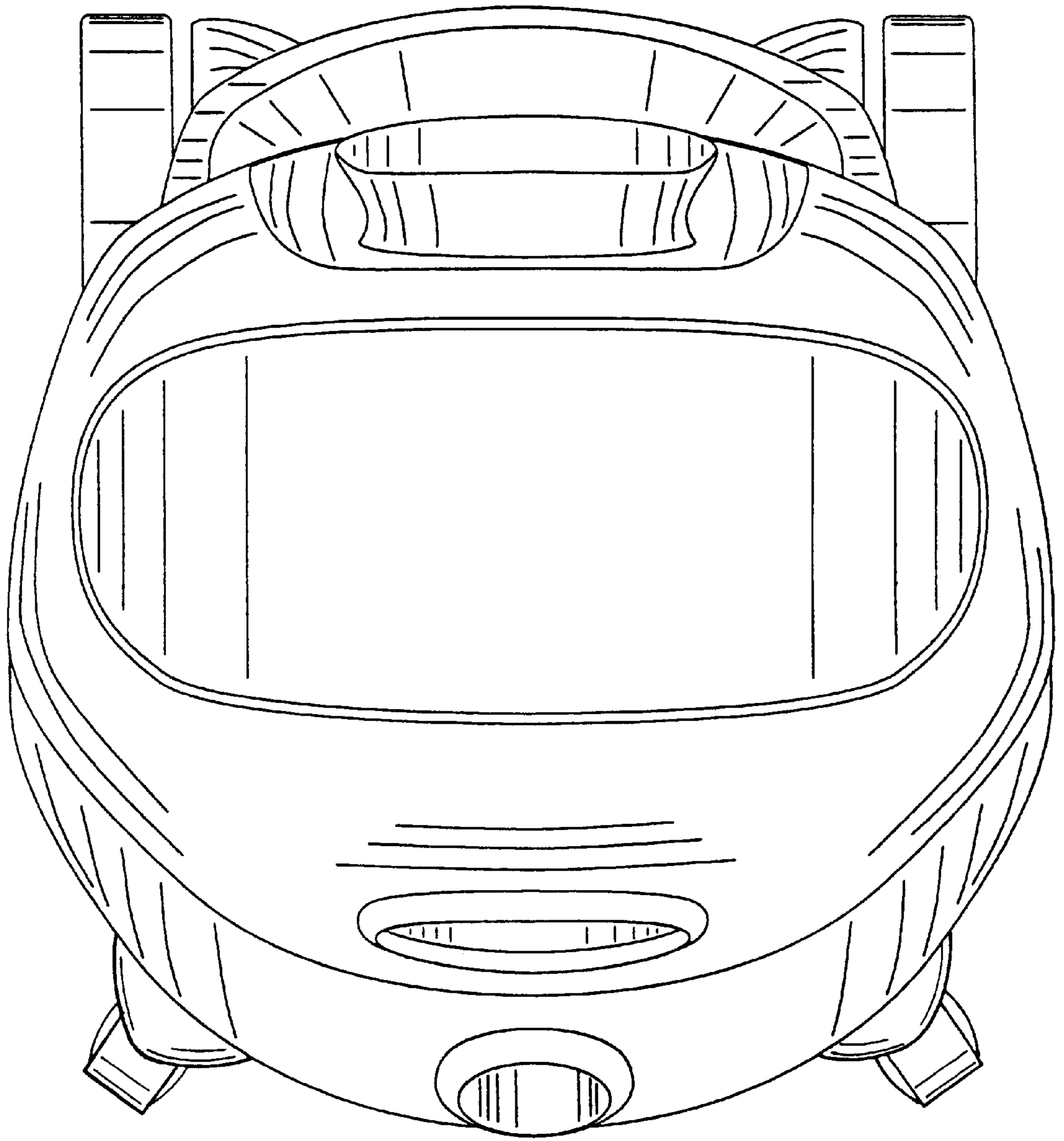

FIG. 6

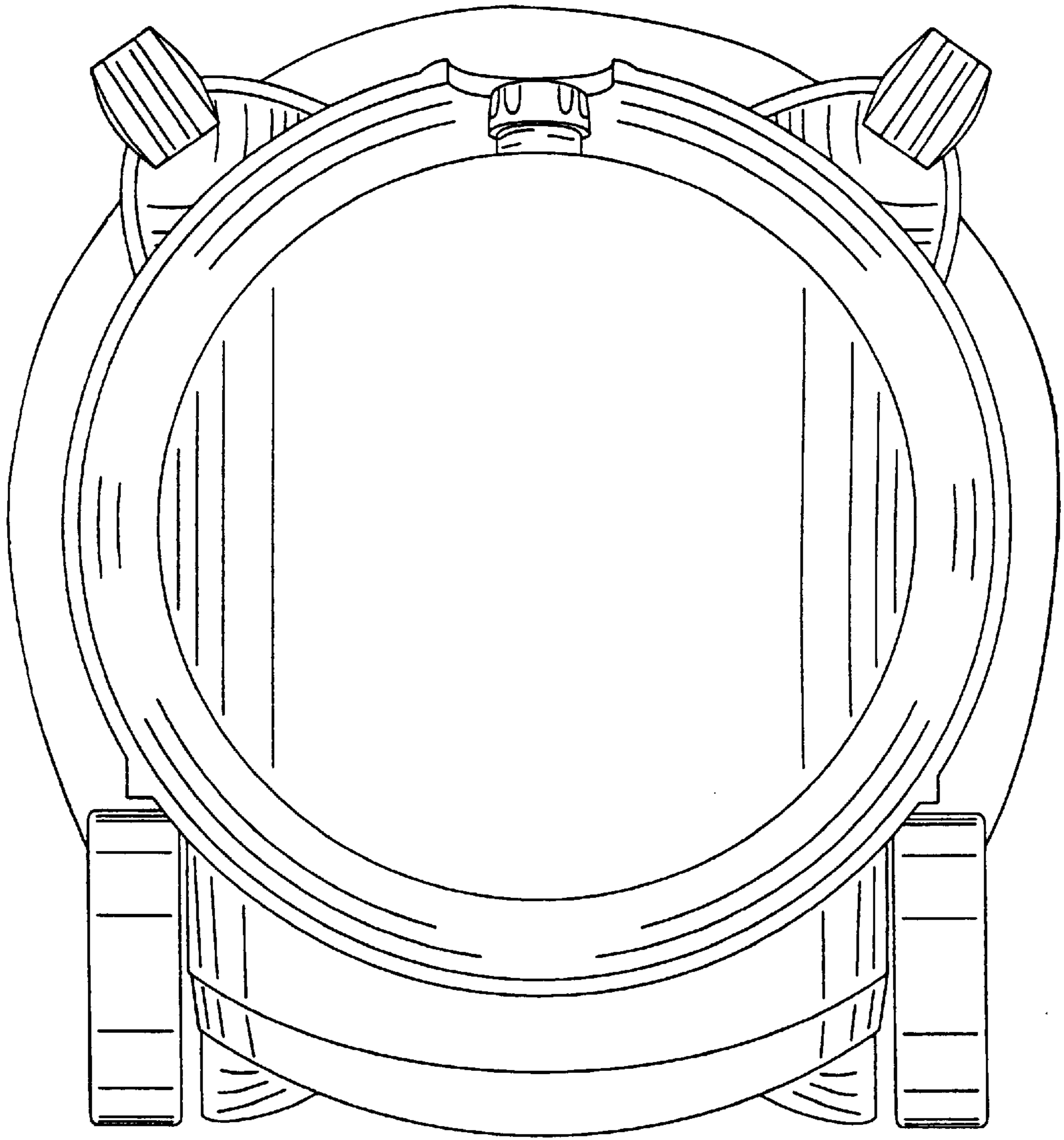

FIG. 7