



US00D429844S

# United States Patent [19]

Harrison

[11] Patent Number: **Des. 429,844**

[45] Date of Patent: **\*\* Aug. 22, 2000**

[54] **COMBINED DISPOSABLE LIGHTER AND HOLDER**

D. 378,622 3/1997 Dimopoulos ..... D27/144  
4,522,583 6/1985 Kraser ..... D27/148 X  
5,682,981 11/1997 Sudborough ..... 431/253 X

[76] Inventor: **Kerry Max Harrison**, Apartment T1,3rd Floor, Block D, Victoria Palace, 13 Blvd., Princesse Charlotte, MC980000, Monaco

*Primary Examiner*—Susan J. Lucas  
*Assistant Examiner*—Jennifer Rivard  
*Attorney, Agent, or Firm*—Baker & McKenzie

[\*\*] Term: **14 Years**

[57] **CLAIM**

[21] Appl. No.: **29/108,982**

I claim the ornamental design for a combined disposable lighter and holder, as shown and described.

[22] Filed: **Aug. 6, 1999**

**DESCRIPTION**

[30] **Foreign Application Priority Data**

Jun. 3, 1999 [AU] Australia ..... PQ 0747

FIG. 1 is a perspective view of the first embodiment of a combined disposable lighter and holder;  
FIG. 2 is a left elevational view;  
FIG. 3 is a right elevational view;  
FIG. 4 is a top plan view;  
FIG. 5 is a bottom view;  
FIG. 6 is a front view;  
FIG. 7 is a rear view; and,  
FIG. 8 is a perspective view of the second embodiment of a combined disposable lighter and holder; it being understood that, with the exception of the lighter head, all other views are identical to the first embodiment.

[51] **LOC (7) Cl.** ..... **27-05**

[52] **U.S. Cl.** ..... **D27/148; D27/161**

[58] **Field of Search** ..... 431/253; 206/85-89; D27/139, 141-161

[56] **References Cited**

**U.S. PATENT DOCUMENTS**

D. 283,734 5/1986 Parren ..... D27/153  
D. 363,567 10/1995 Feeley et al. .... D27/148

**1 Claim, 3 Drawing Sheets**

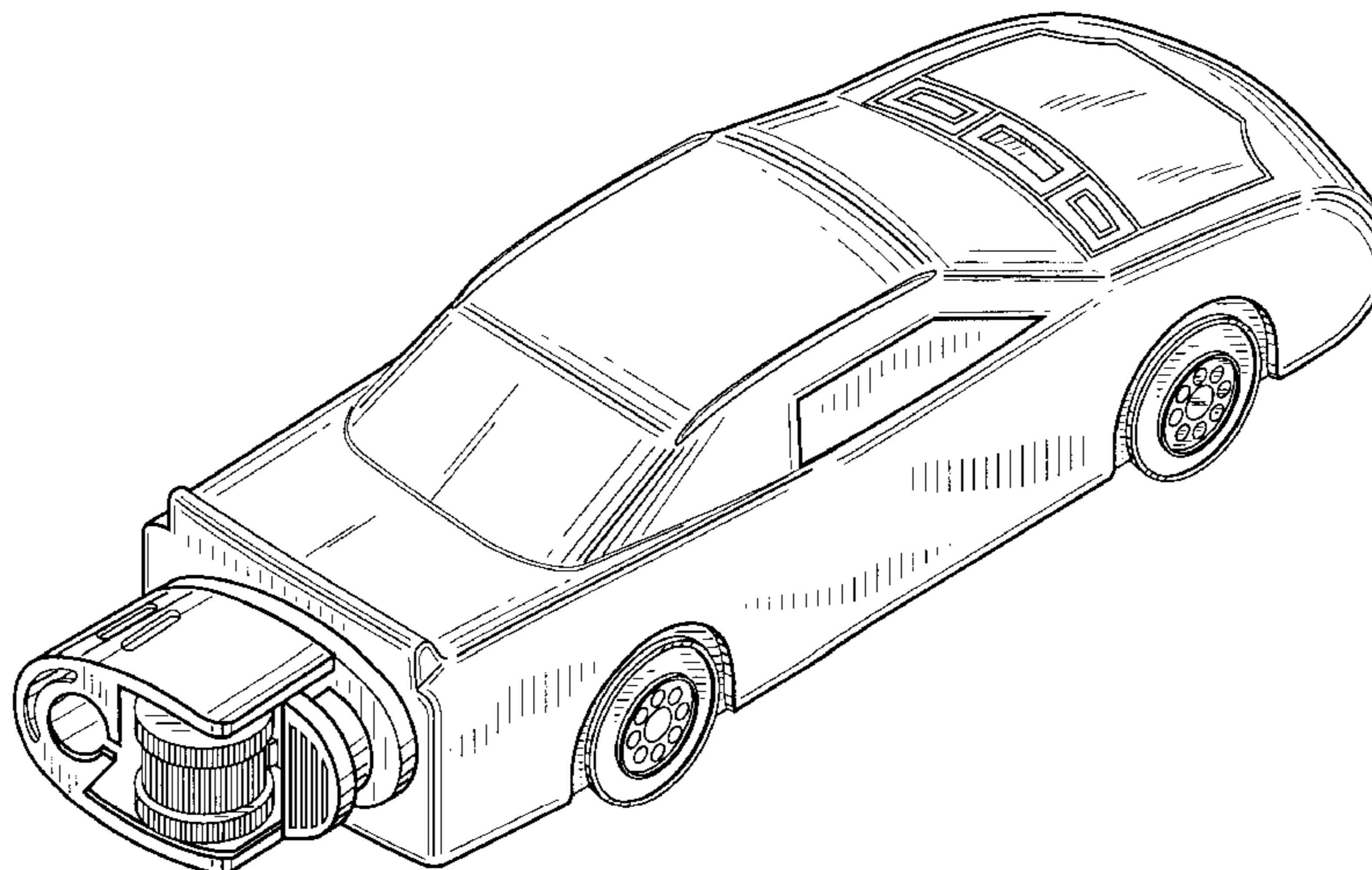
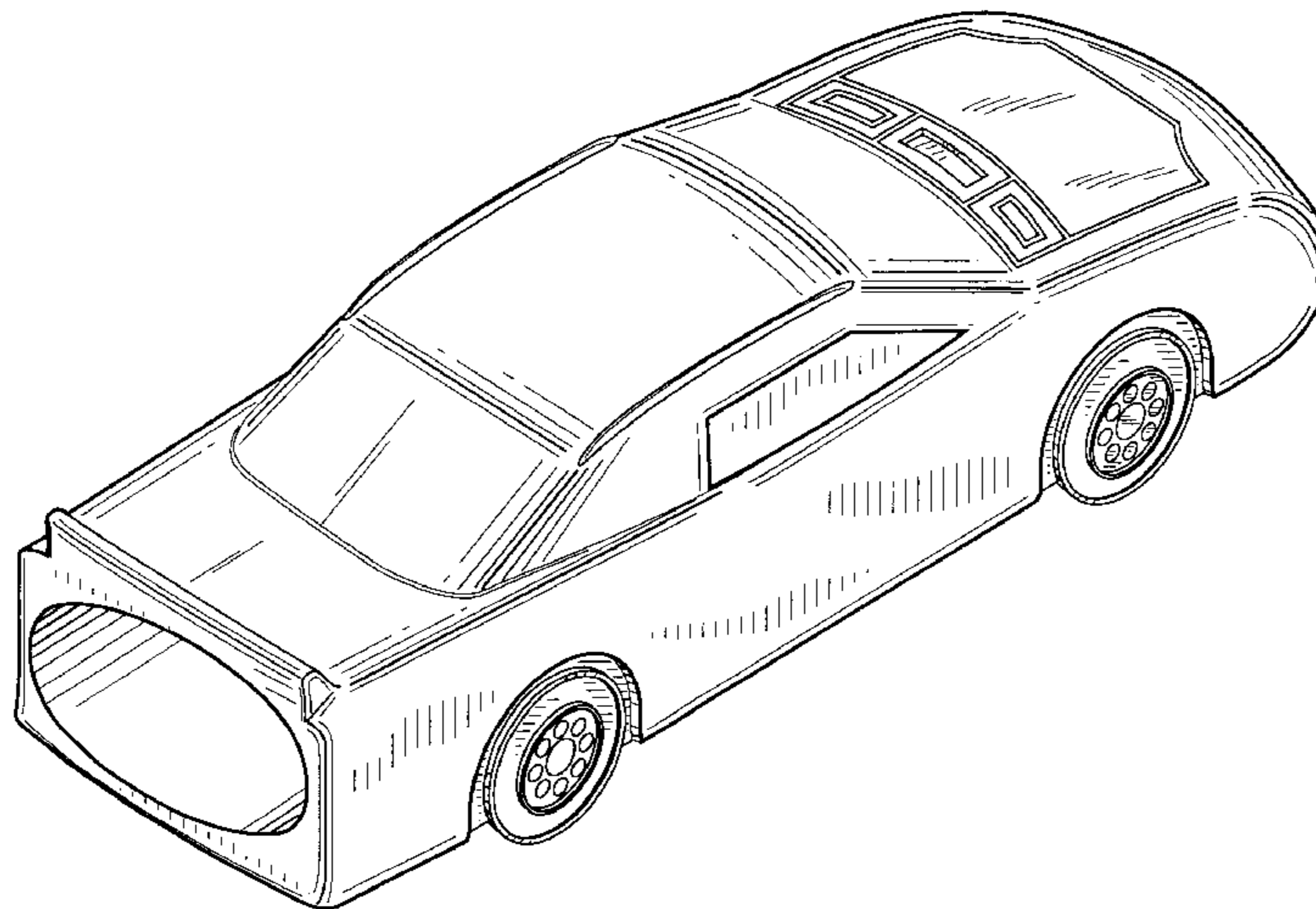

FIG. 1

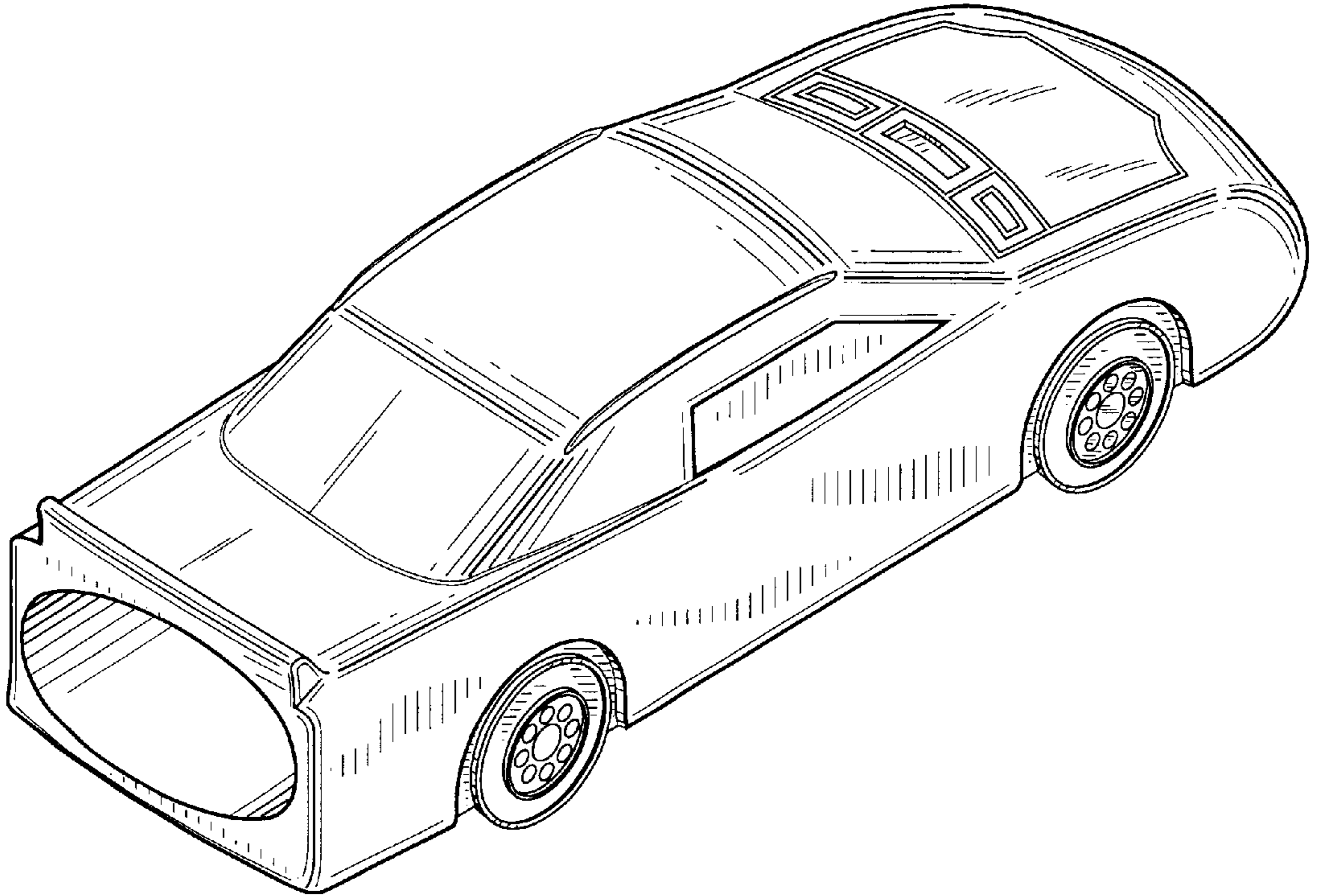

FIG. 2

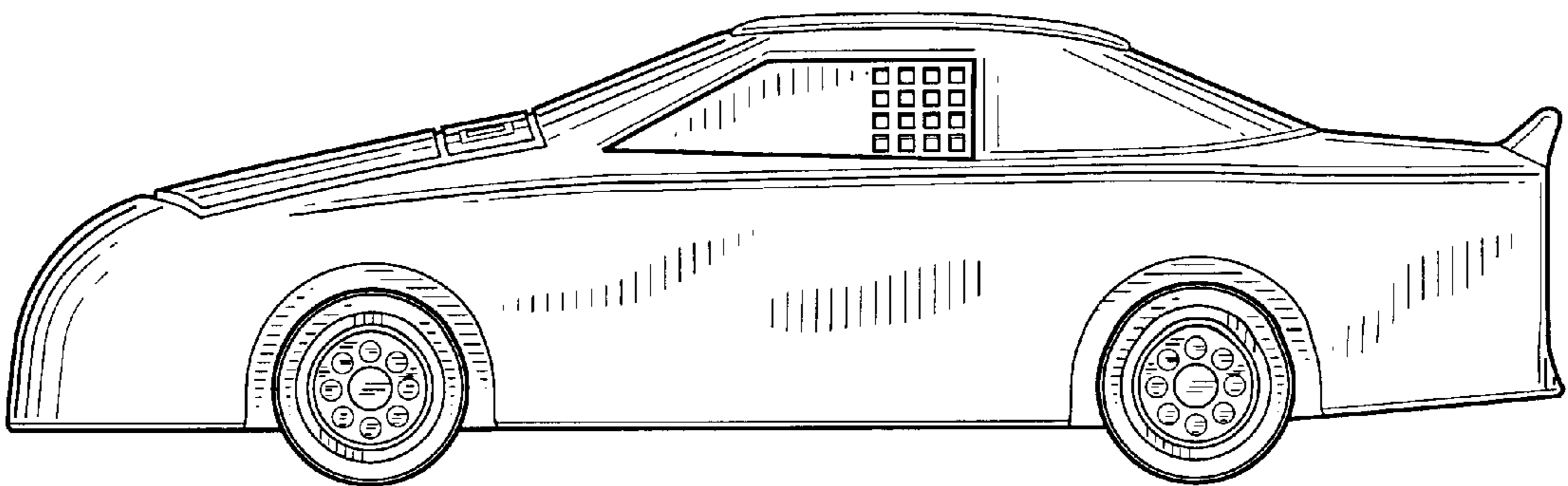

FIG. 3

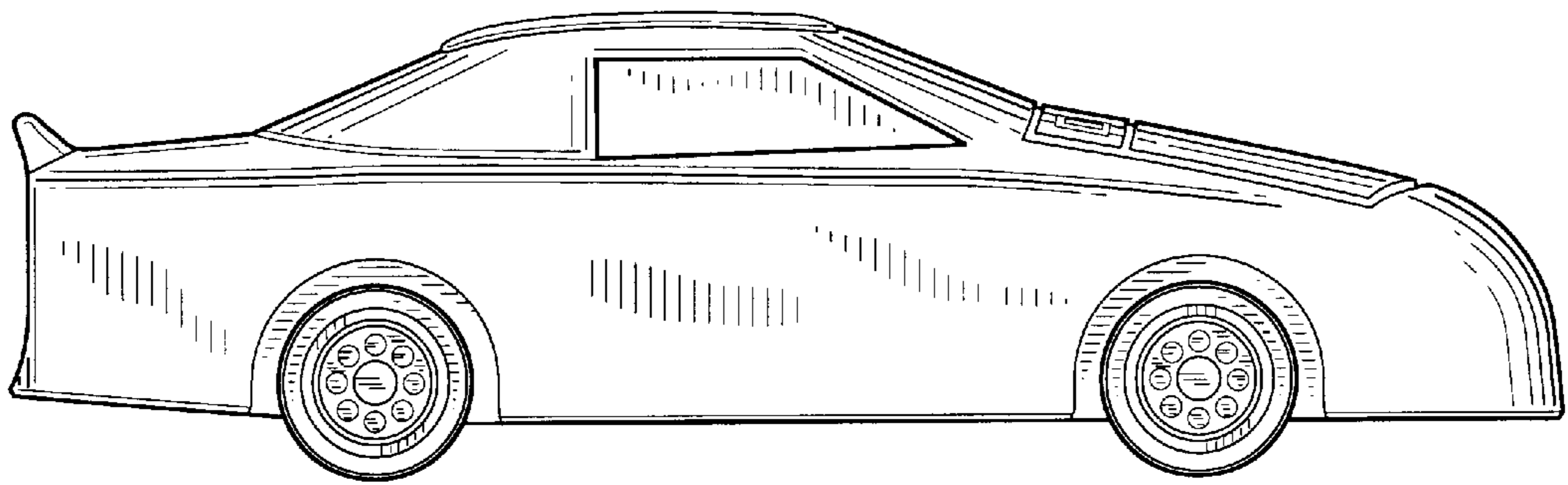

FIG. 4

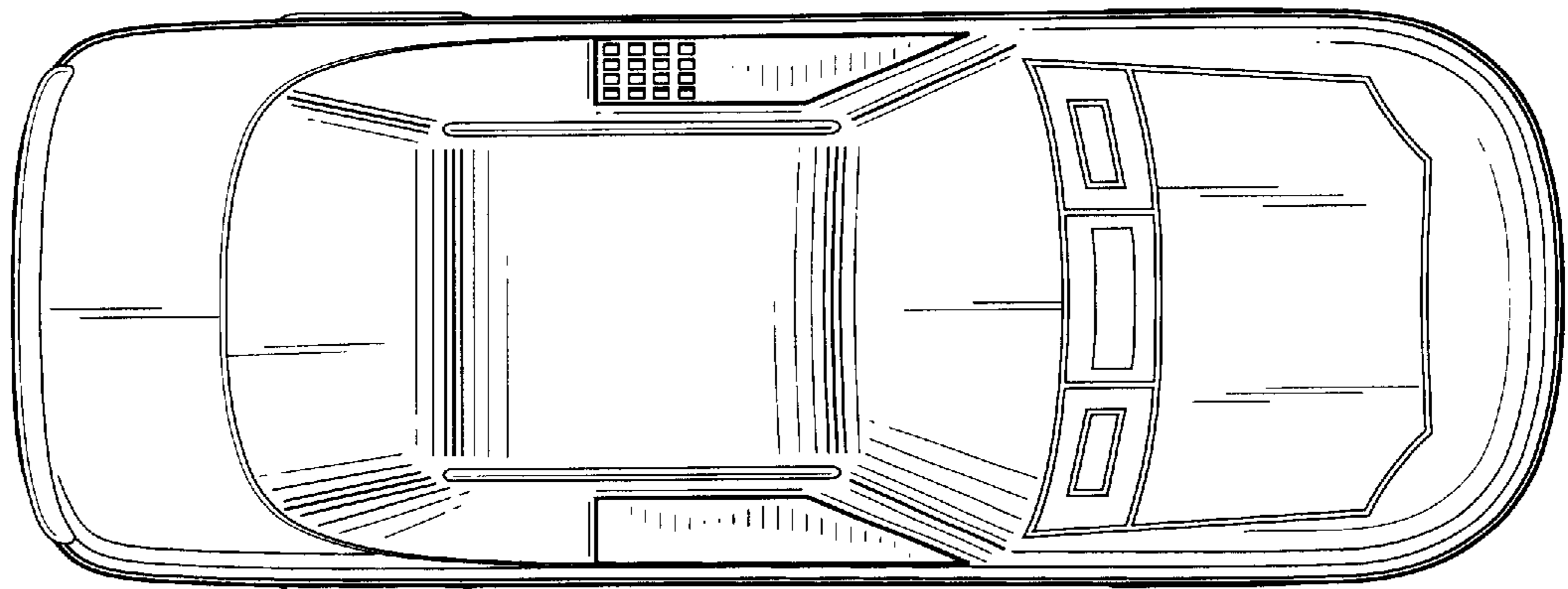
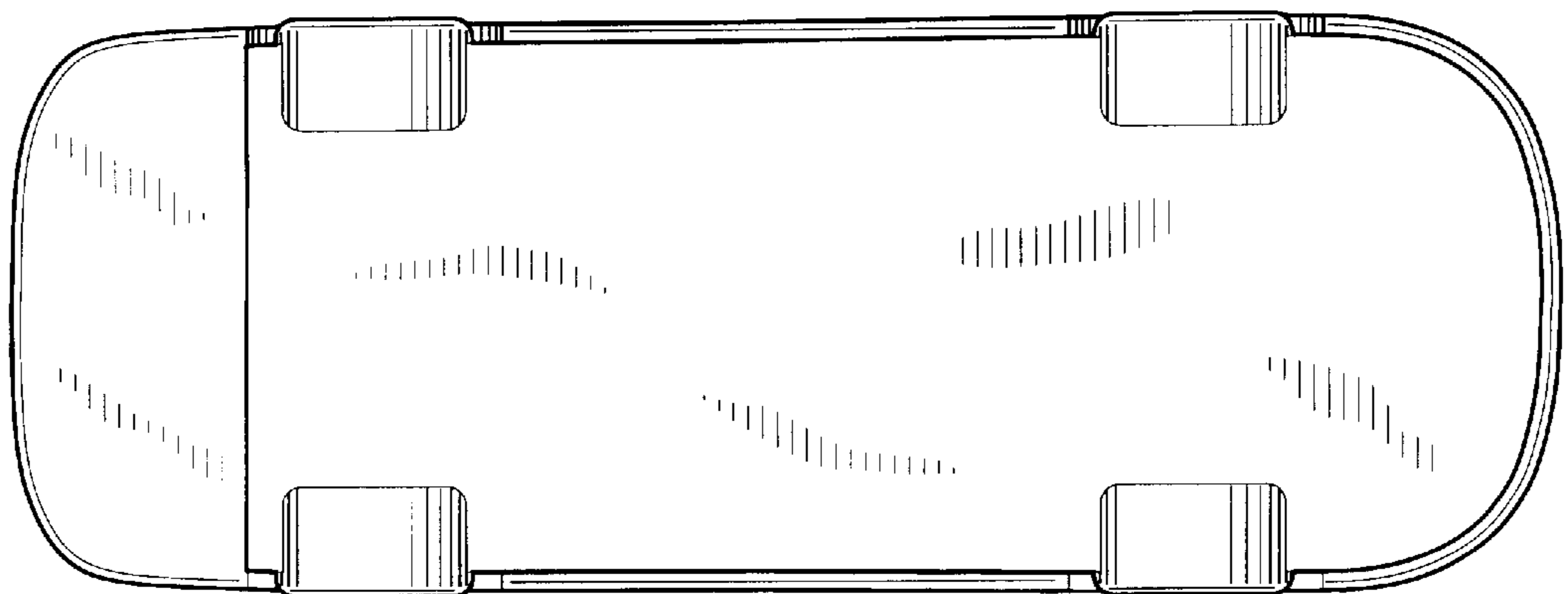
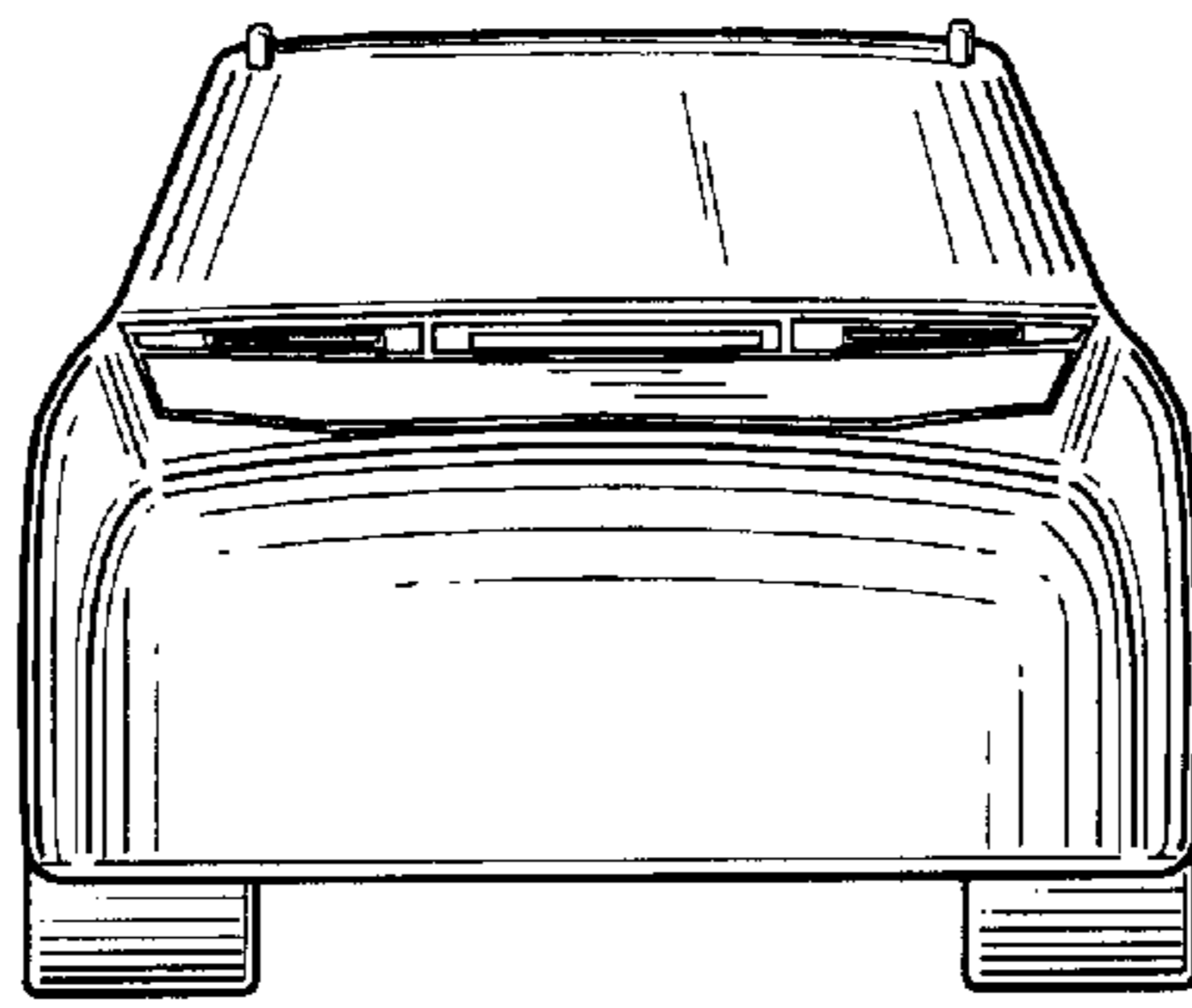

FIG. 5



**FIG. 6**



**FIG. 7**

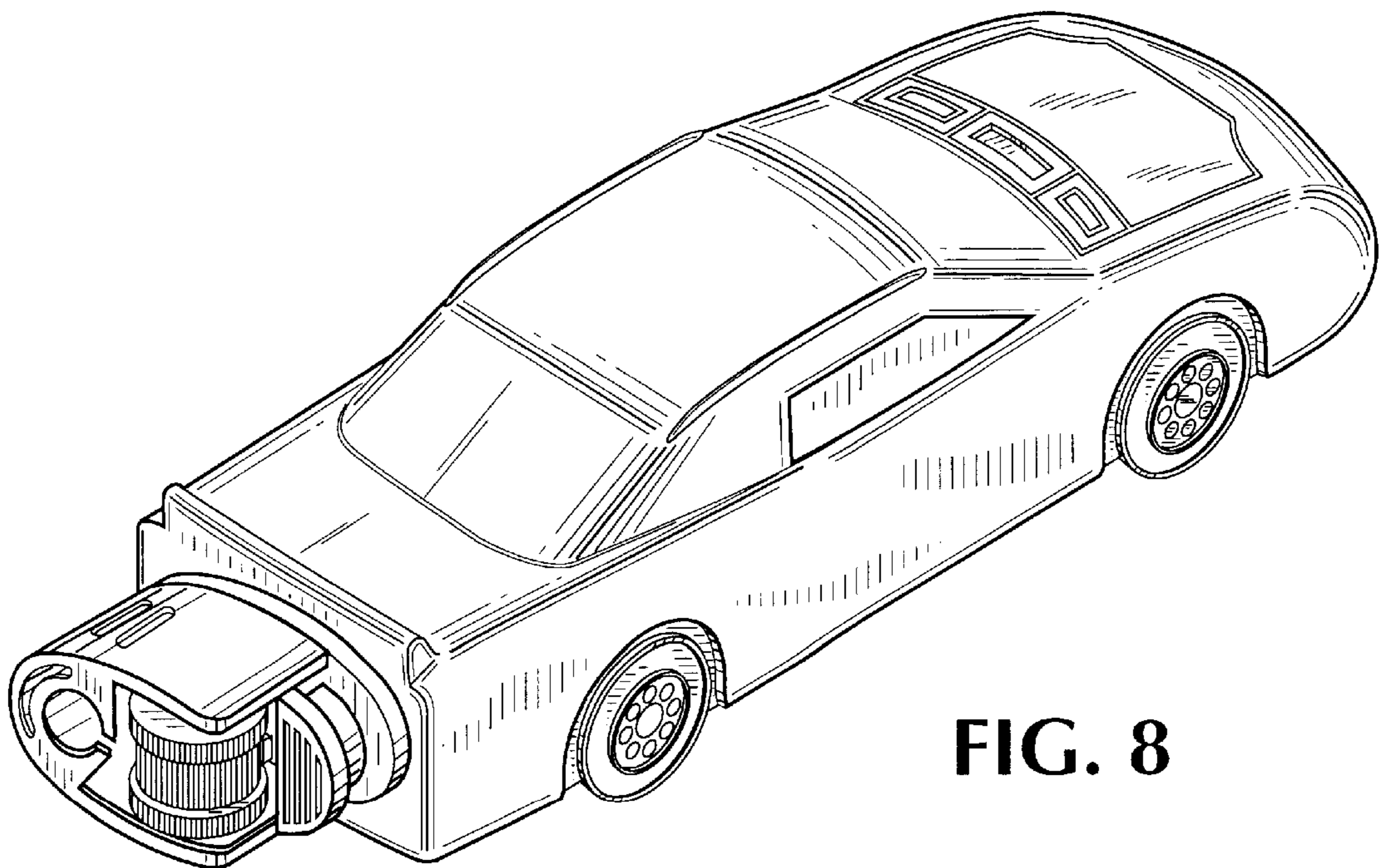
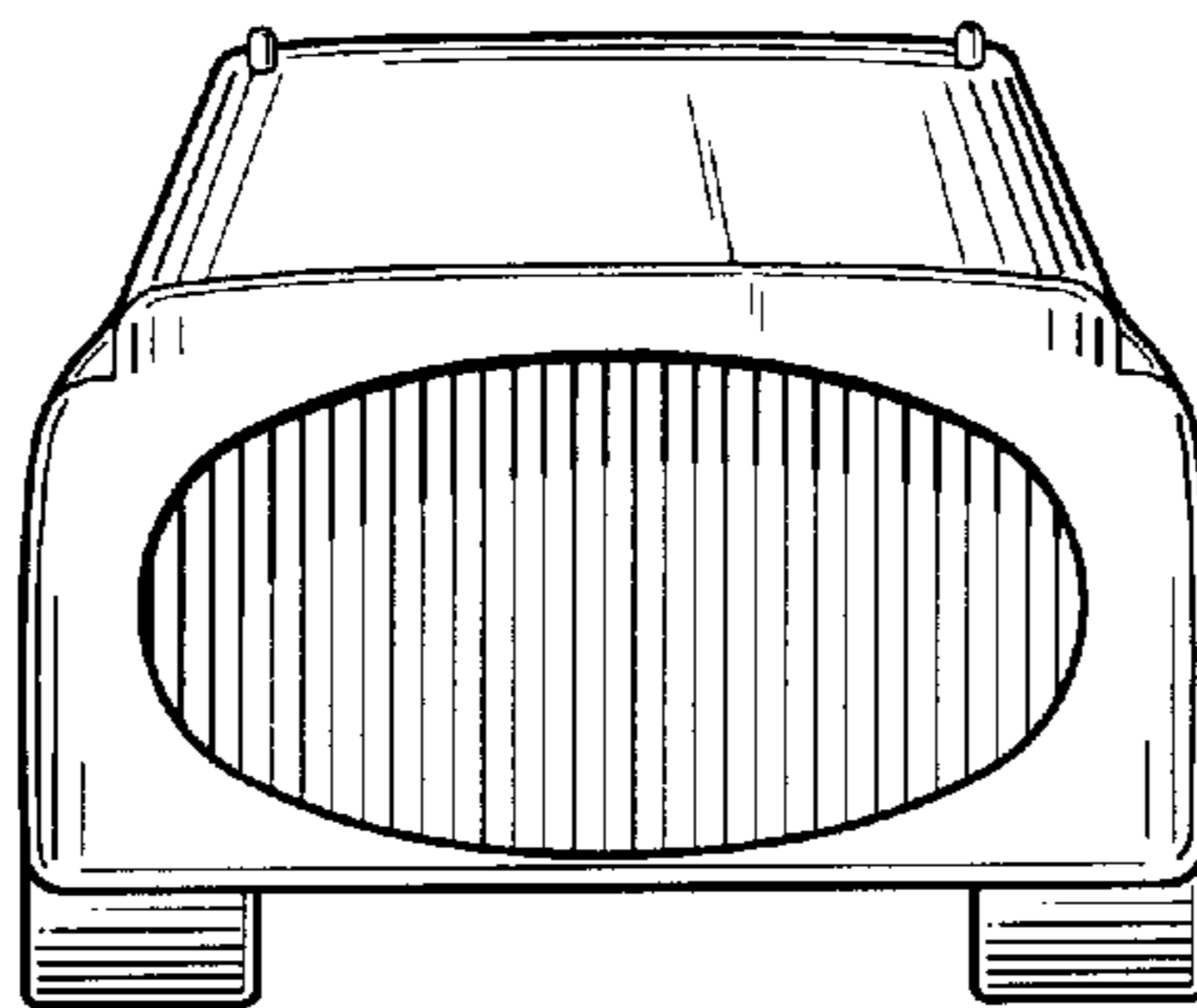

**FIG. 8**