



US00D429841S

United States Patent [19]

Swanson

[11] Patent Number: Des. 429,841

[45] Date of Patent: ** Aug. 22, 2000

[54] TORCHIERE FLOOR LAMP WITH TIFFANY SHADES

[75] Inventor: Dennis K. Swanson, Woodland Hills, Calif.

[73] Assignee: Lamps Plus, Inc., Chatsworth, Calif.

[**] Term: 14 Years

[21] Appl. No.: 29/111,450

[22] Filed: Sep. 28, 1999

[51] LOC (7) Cl. 26-03

[52] U.S. Cl. D26/110

[58] Field of Search D26/93-112; 362/410-414

[56] References Cited

PUBLICATIONS

Taiwan Lighting, p. 122, Lamp (a), right side of page, Mar. 9, 2000.

Primary Examiner—Lisa Lichtenstein
Attorney, Agent, or Firm—Fulbright & Jaworski L.L.P.

[57] CLAIM

The ornamental design of a torchiere floor lamp with tiffany shades substantially, as shown and described.

DESCRIPTION

FIG. 1 is a perspective view of a torchiere floor lamp with tiffany shades of the present invention; FIG. 2 is a front elevational view thereof; FIG. 3 is a rear elevational view thereof; FIG. 4 is a right side view thereof; FIG. 5 is a left side view thereof; and, FIG. 6 is a top view thereof; and, FIG. 7 is an enlarged cross-sectional view of the stem thereof taken along line 7—7 in FIG. 2.

The surface(s) or portion(s) of the article not shown in the drawing or described in the specification form(s) no part of the claimed design.

The broken-line showing of environmental structure in FIGS. 1-6 is for illustrative purposes only and forms no part of the claimed design.

1 Claim, 3 Drawing Sheets

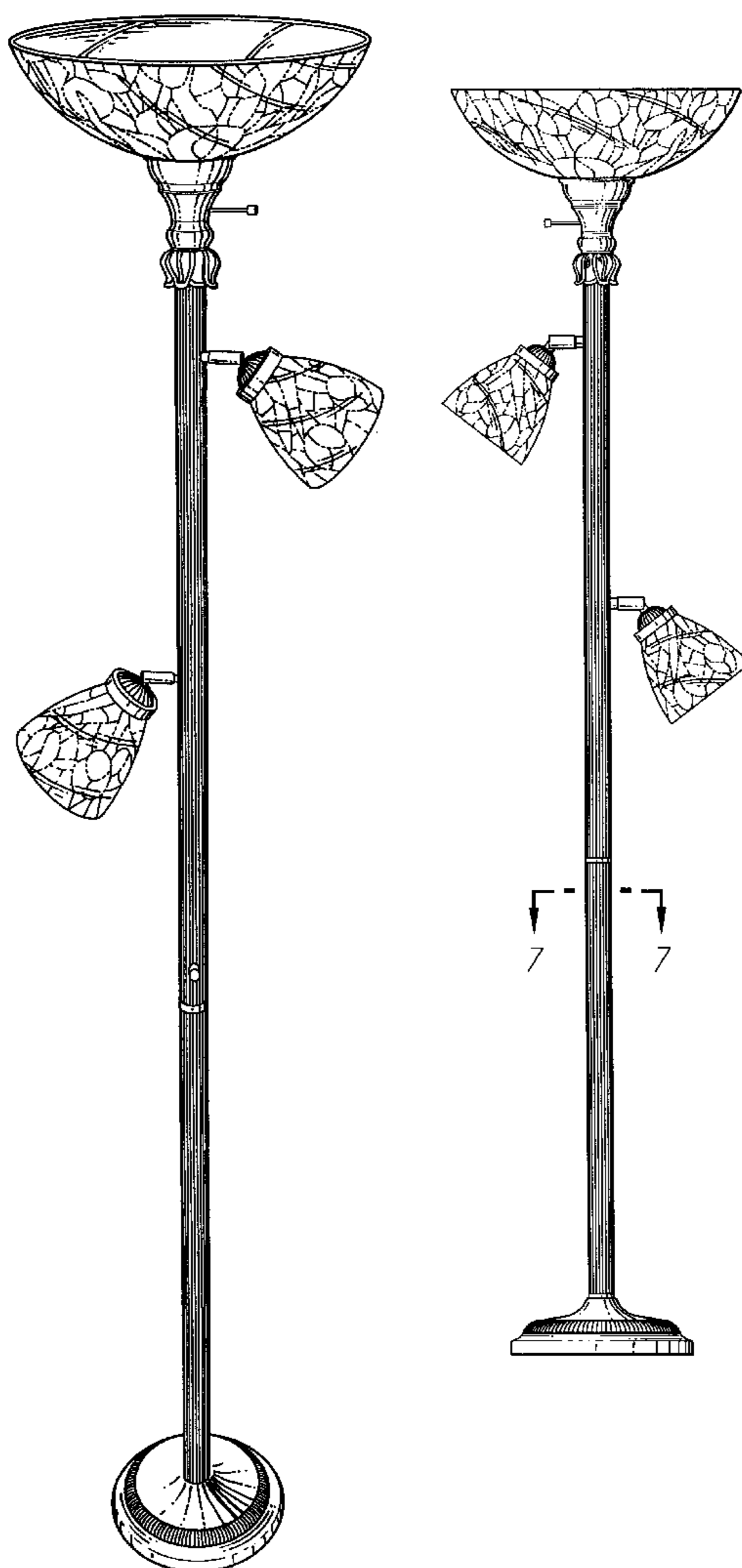
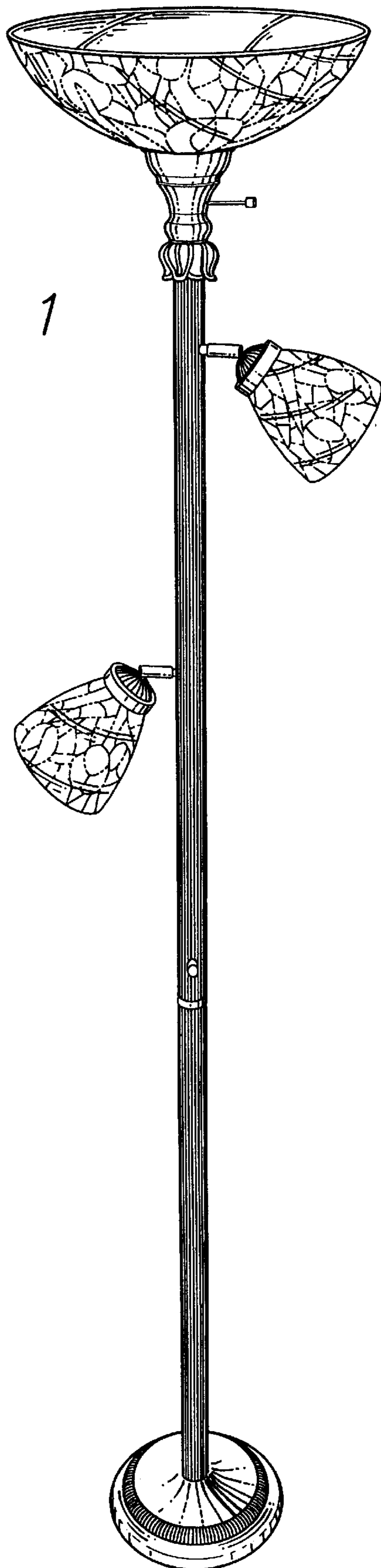
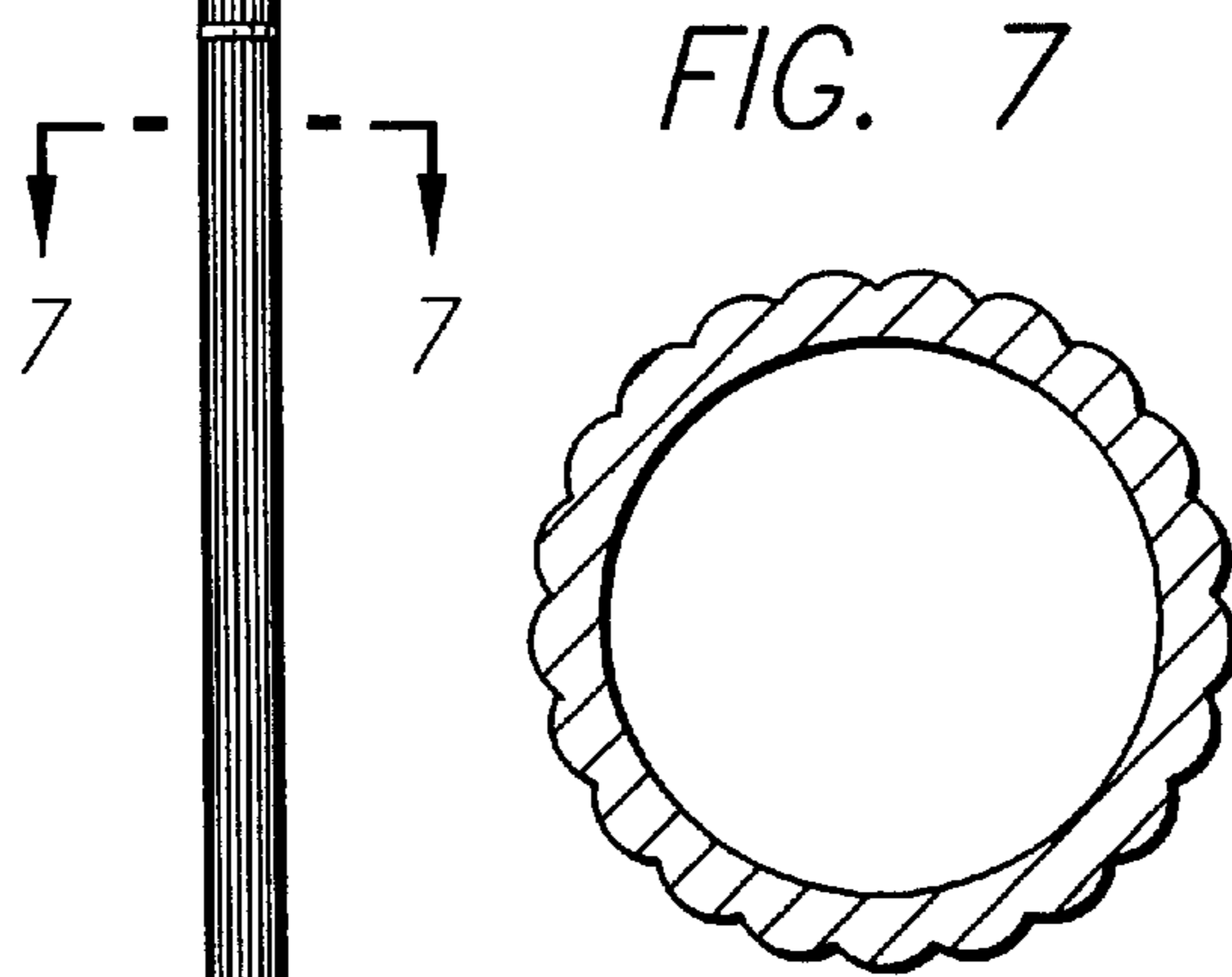
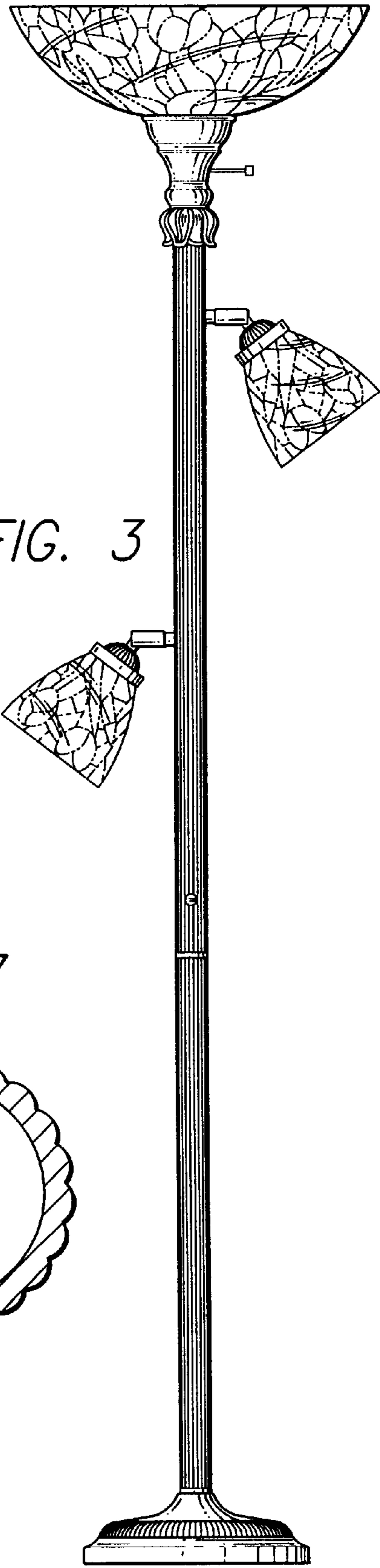
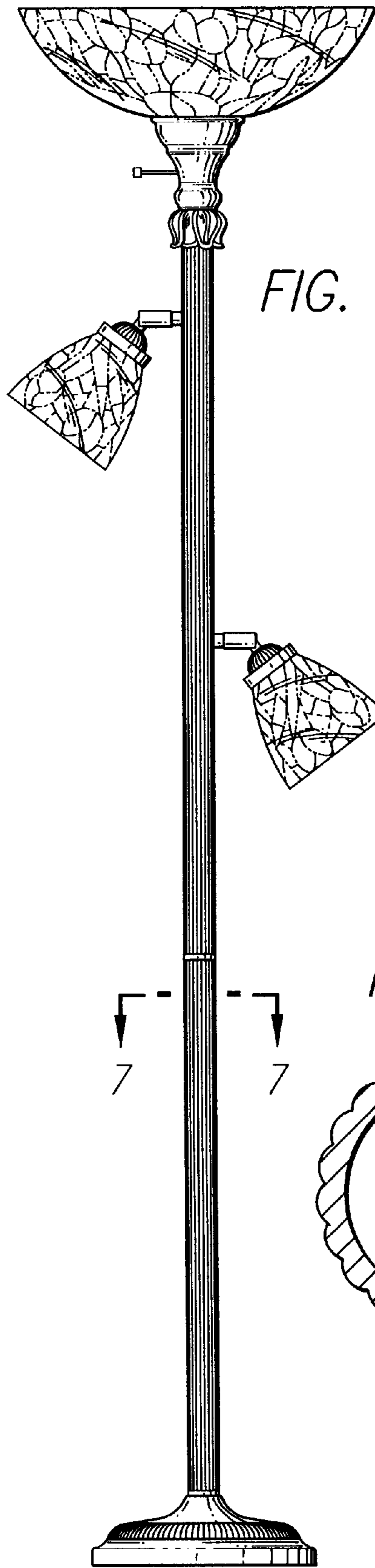

FIG. 1





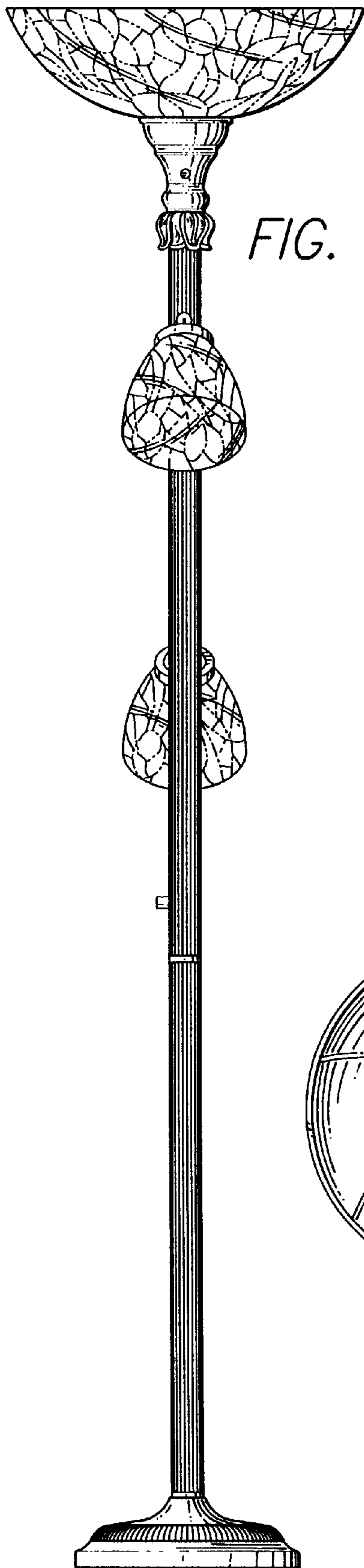

FIG. 4

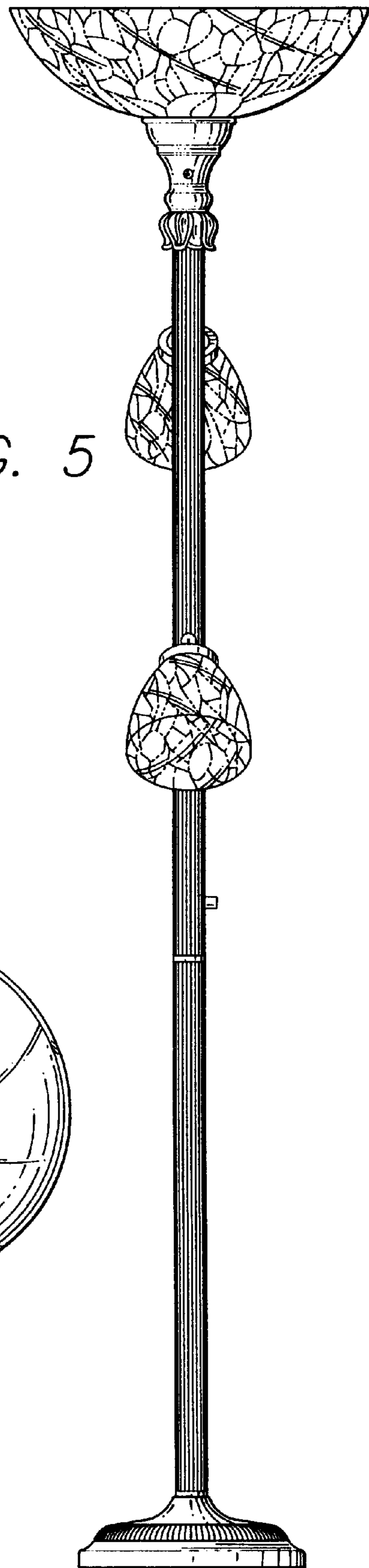

FIG. 5

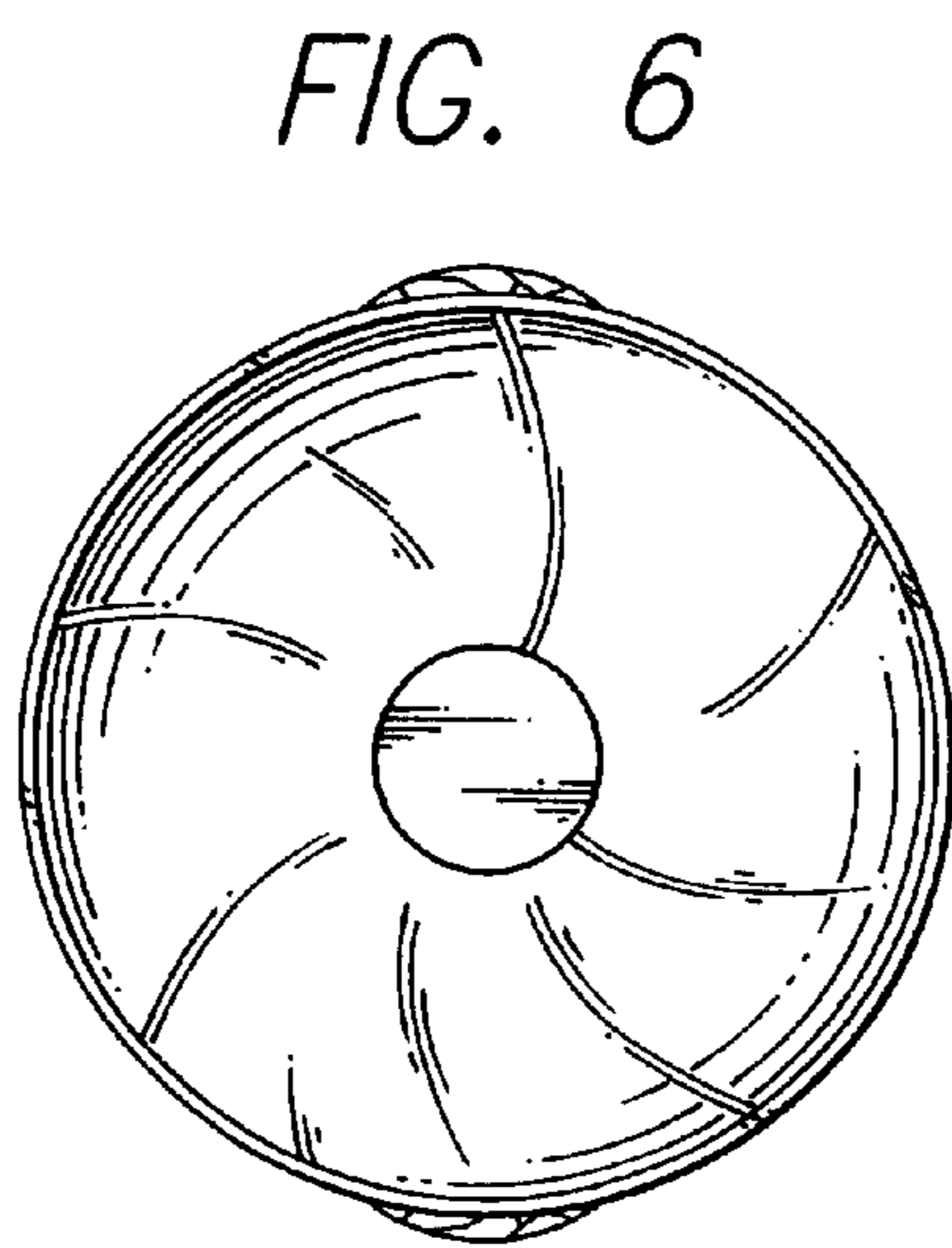

FIG. 6