



US00D429787S

**United States Patent** [19]  
**Peterson**

[11] **Patent Number: Des. 429,787**

[45] **Date of Patent: \*\* Aug. 22, 2000**

[54] **INFLATABLE TOWABLE VEHICLE**

5,167,554 12/1992 Tager et al. .... 441/131  
6,012,778 1/2000 Peterson ..... 297/452.41

[75] Inventor: **Leroy L. Peterson**, Omaha, Nebr.

*Primary Examiner*—Kay H. Chin  
*Attorney, Agent, or Firm*—Henderson & Sturm LLP

[73] Assignee: **Sportsstuff, Inc.**, Omaha, Nebr.

[\*\*] Term: **14 Years**

[57] **CLAIM**

[21] Appl. No.: **29/117,686**

The ornamental design for an inflatable towable vehicle, as shown and described.

[22] Filed: **Jan. 27, 2000**

**DESCRIPTION**

[51] **LOC (7) Cl.** ..... **21-06**

[52] **U.S. Cl.** ..... **D21/803**

[58] **Field of Search** ..... D21/801-810;  
441/40, 80, 129-132; D12/316; 297/452.41

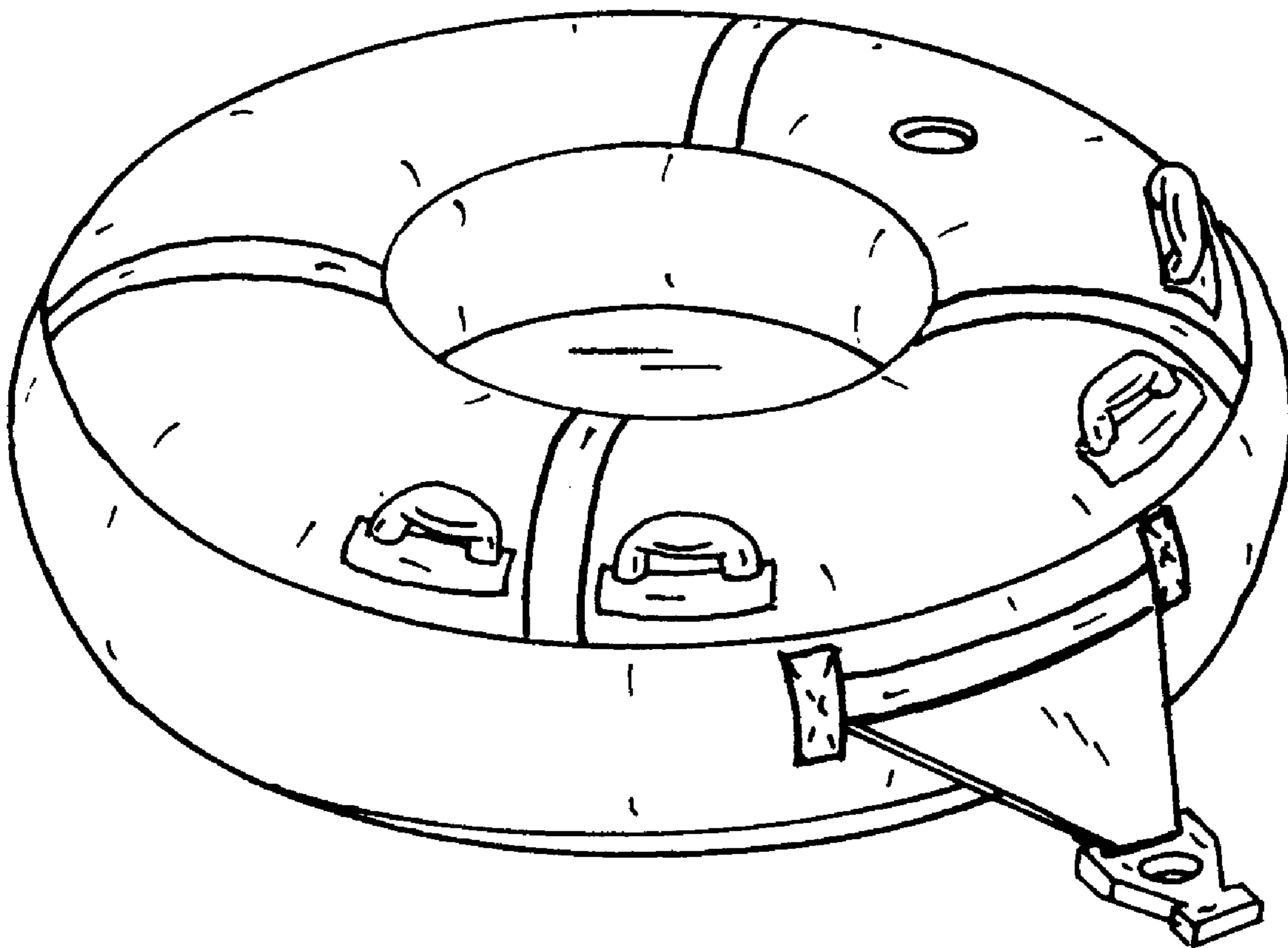
FIG. 1 is a perspective view of the inflatable towable vehicle showing my new design;  
FIG. 2 is a top plan view thereof;  
FIG. 3 is a front elevational view thereof;  
FIG. 4 is a bottom plan view thereof;  
FIG. 5 is a rear elevational view thereof;  
FIG. 6 is a left side elevational view thereof; and,  
FIG. 7 is a right side elevational view thereof.

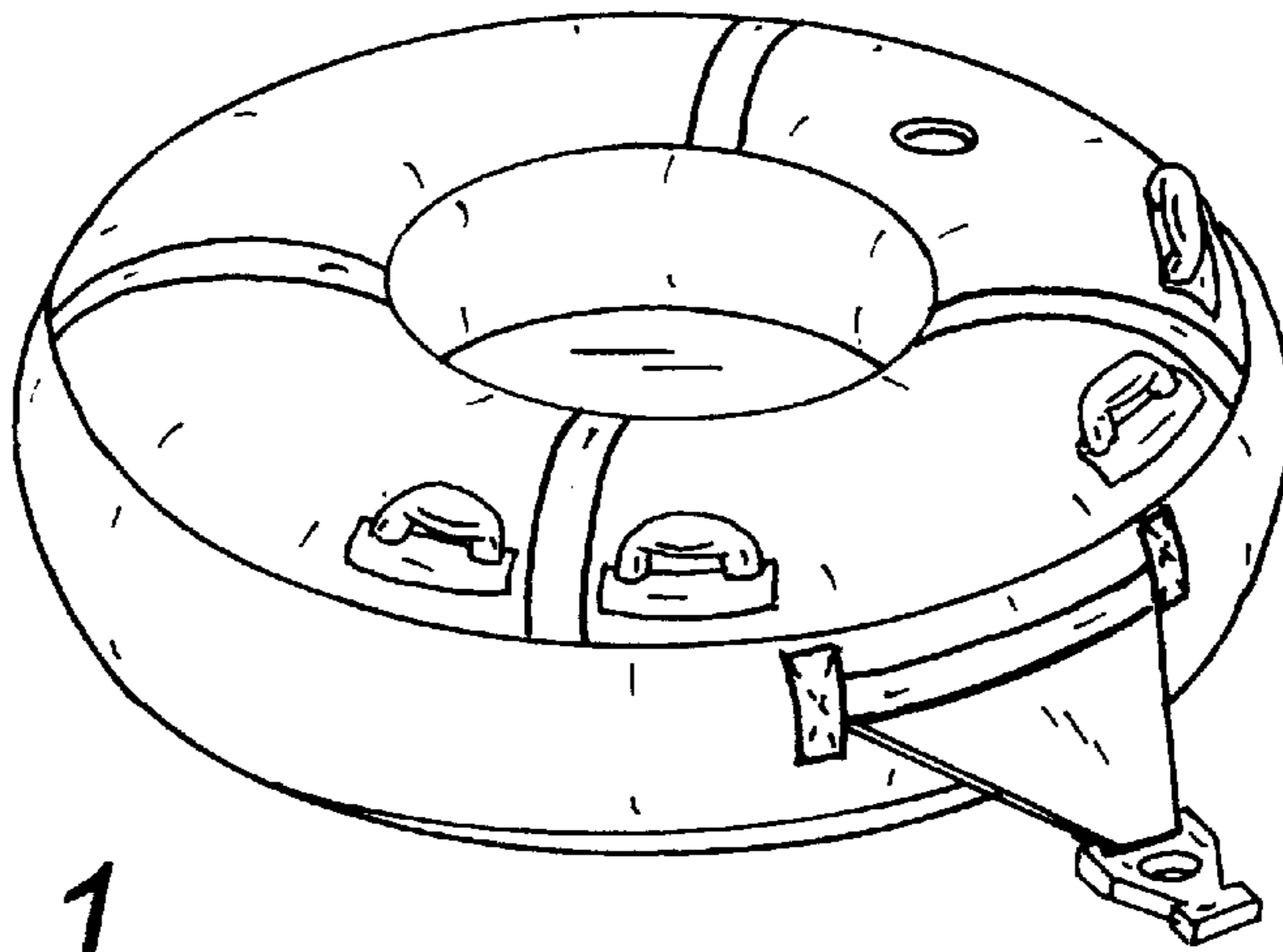
[56] **References Cited**

**U.S. PATENT DOCUMENTS**

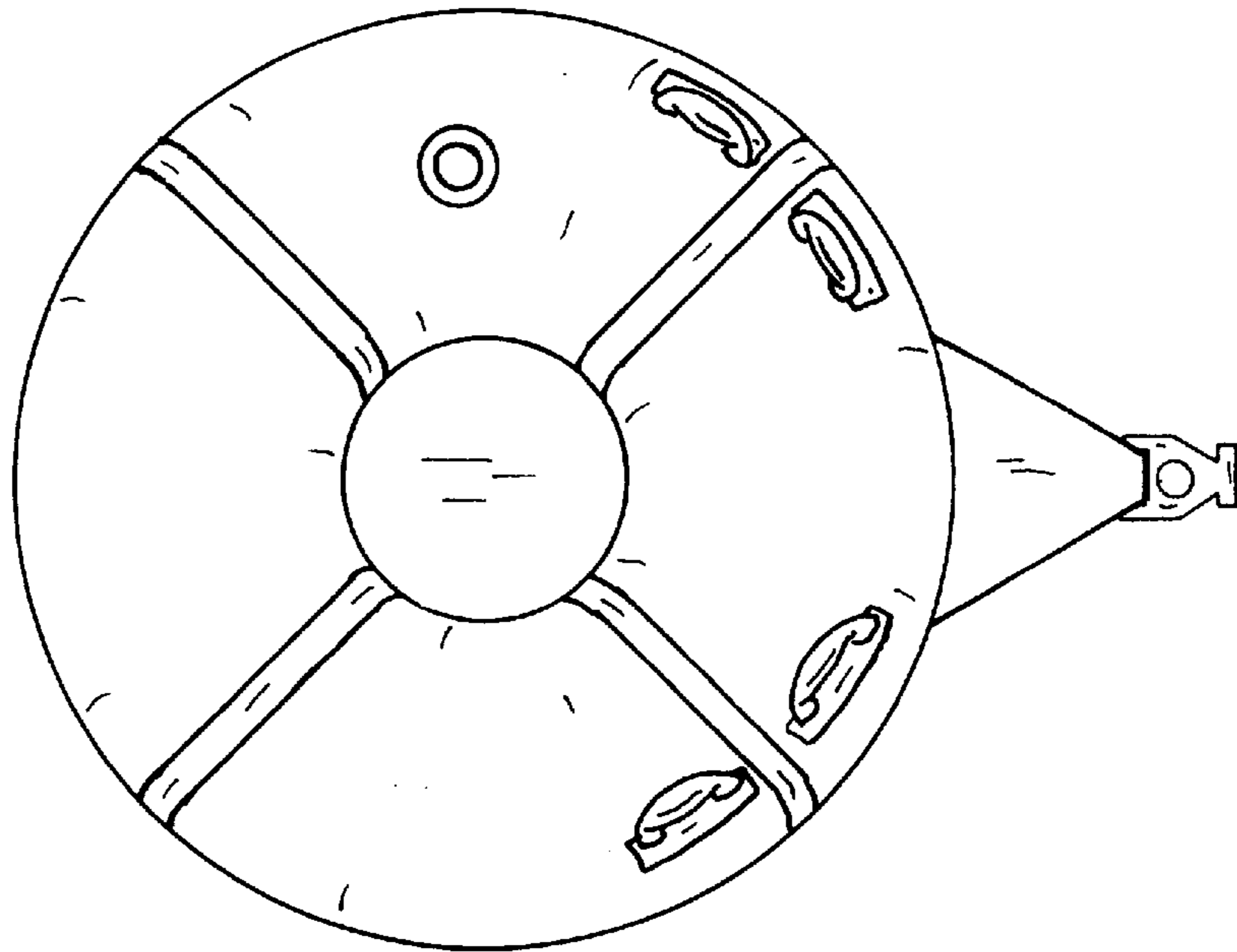
D. 393,038 3/1998 Peterson ..... D21/803  
D. 393,680 4/1998 Peterson ..... D21/803

**1 Claim, 2 Drawing Sheets**

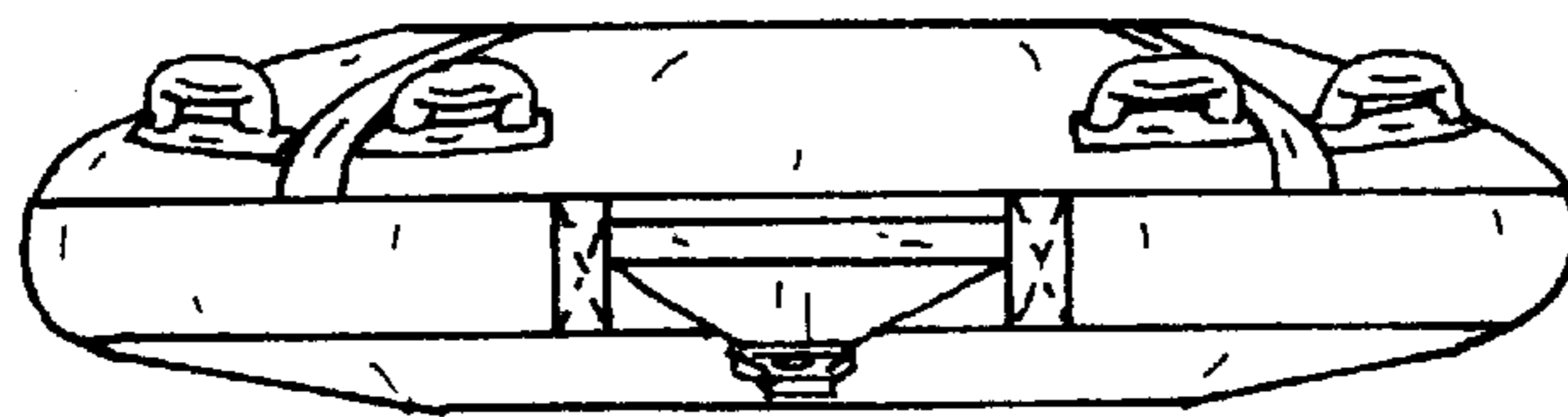




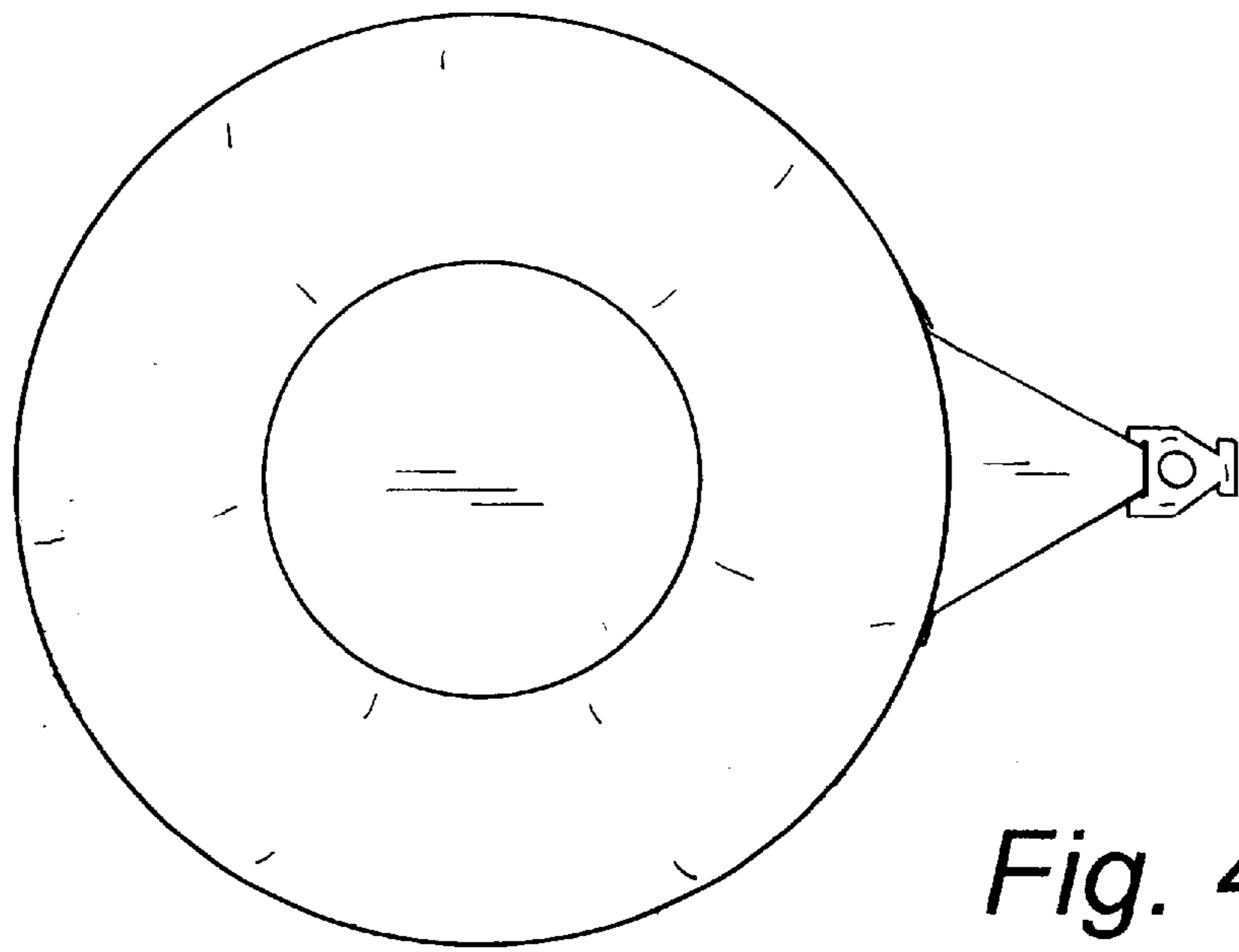
*Fig. 1*



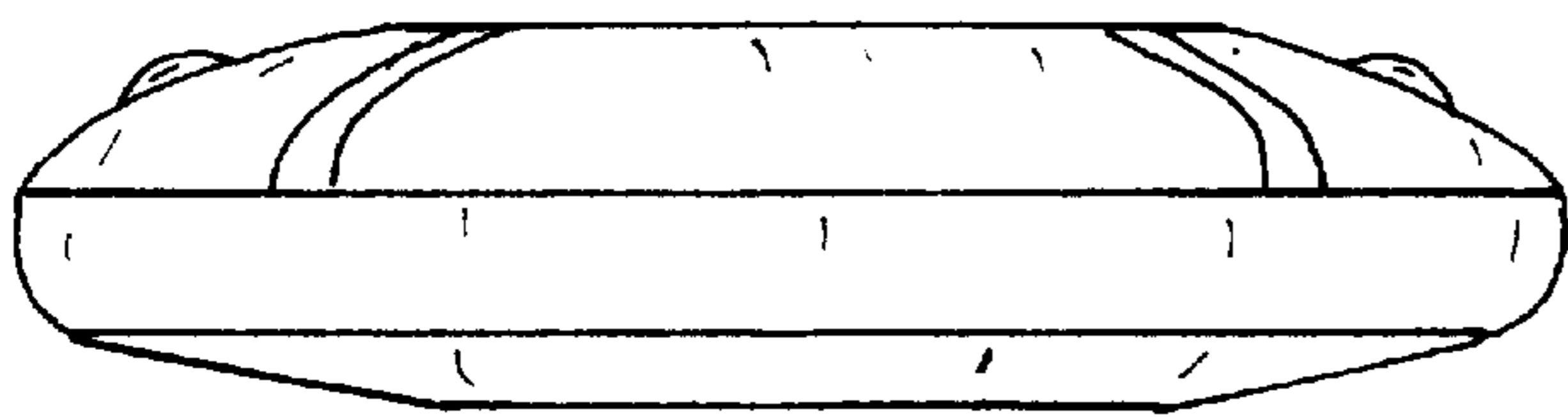
*Fig. 2*



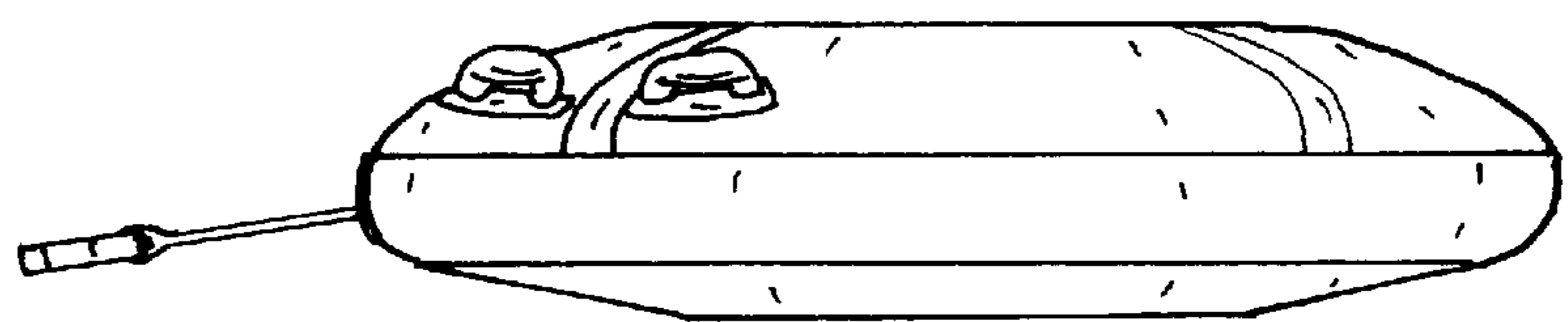
*Fig. 3*



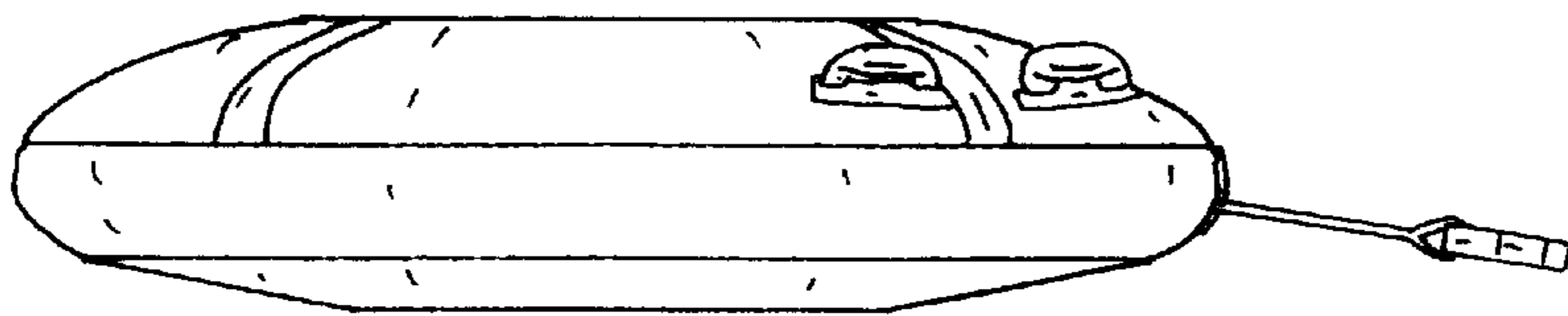
*Fig. 4*



*Fig. 5*



*Fig. 6*



*Fig. 7*