



US00D429711S

United States Patent [19] Afshar-Ghochani

[11] Patent Number: **Des. 429,711**

[45] Date of Patent: **** Aug. 22, 2000**

[54] **PAY TELEPHONE**

[75] Inventor: **Shahram Afshar-Ghochani**, Tampa, Fla.

[73] Assignee: **Protel, Inc.**, Lakeland, Fla.

[**] Term: **14 Years**

[21] Appl. No.: **29/111,157**

[22] Filed: **Sep. 21, 1999**

[51] **LOC (7) Cl.** **14-03**

[52] **U.S. Cl.** **D14/146**

[58] **Field of Search** D14/130, 140, D14/142, 149-151, 146, 240; 379/433-436, 438, 419, 420, 428, 440, 430, 453, 143-155, 368, 441, 442

[56] **References Cited**

U.S. PATENT DOCUMENTS

D. 256,692	9/1980	Genaro et al.	D14/146
D. 265,558	7/1982	Fox et al.	D14/146
D. 277,480	2/1985	Jackwicz et al.	D14/142
D. 290,954	7/1987	Read .		
D. 302,273	7/1989	Adachi et al.	D14/146
D. 304,190	10/1989	Rose	D14/142
D. 305,890	2/1990	Read .		
D. 315,485	3/1991	Schremmer et al.	D14/146
D. 323,656	2/1992	McGarvey et al.	D14/146
D. 342,251	12/1993	Hird et al.	D14/146
D. 351,163	10/1994	Kwon et al.	D14/146
D. 375,307	11/1996	Lamora	D14/146
D. 410,003	5/1999	Lamora	D14/146
D. 410,004	5/1999	LaPorte et al.	D14/146

D. 411,194	6/1999	Wilson	D14/130
D. 423,496	4/2000	Chuang	D14/146
D. 424,049	5/2000	Ho et al.	D14/130
4,974,257	11/1990	Ibanez et al.	379/143

Primary Examiner—Jeffrey Asch
Attorney, Agent, or Firm—Allen, Dyer, Doppelt, Milbrath & Gilchrist, P.A.

[57] **CLAIM**

The ornamental design for a pay telephone, as shown and described.

DESCRIPTION

FIG. 1 is a front, top, and left side perspective view of a pay telephone showing my new design; FIG. 2 is a left side elevation view thereof; FIG. 3 is a front elevation view thereof; FIG. 4 is a top plan view thereof; FIG. 5 is a rear elevation view thereof; FIG. 6 is a right side elevation view thereof; FIG. 7 is a bottom side view thereof; FIG. 8 is a front, top, and left side perspective view of an alternate embodiment of FIG. 1; FIG. 9 is a left side elevation view thereof; FIG. 10 is a front elevation view thereof; FIG. 11 is a top plan view thereof; FIG. 12 is a rear elevation view thereof; FIG. 13 is a right side elevation view thereof; and, FIG. 14 is a bottom side view thereof. The broken line showings are for illustrative purposes only and form no part of the claimed design.

1 Claim, 8 Drawing Sheets

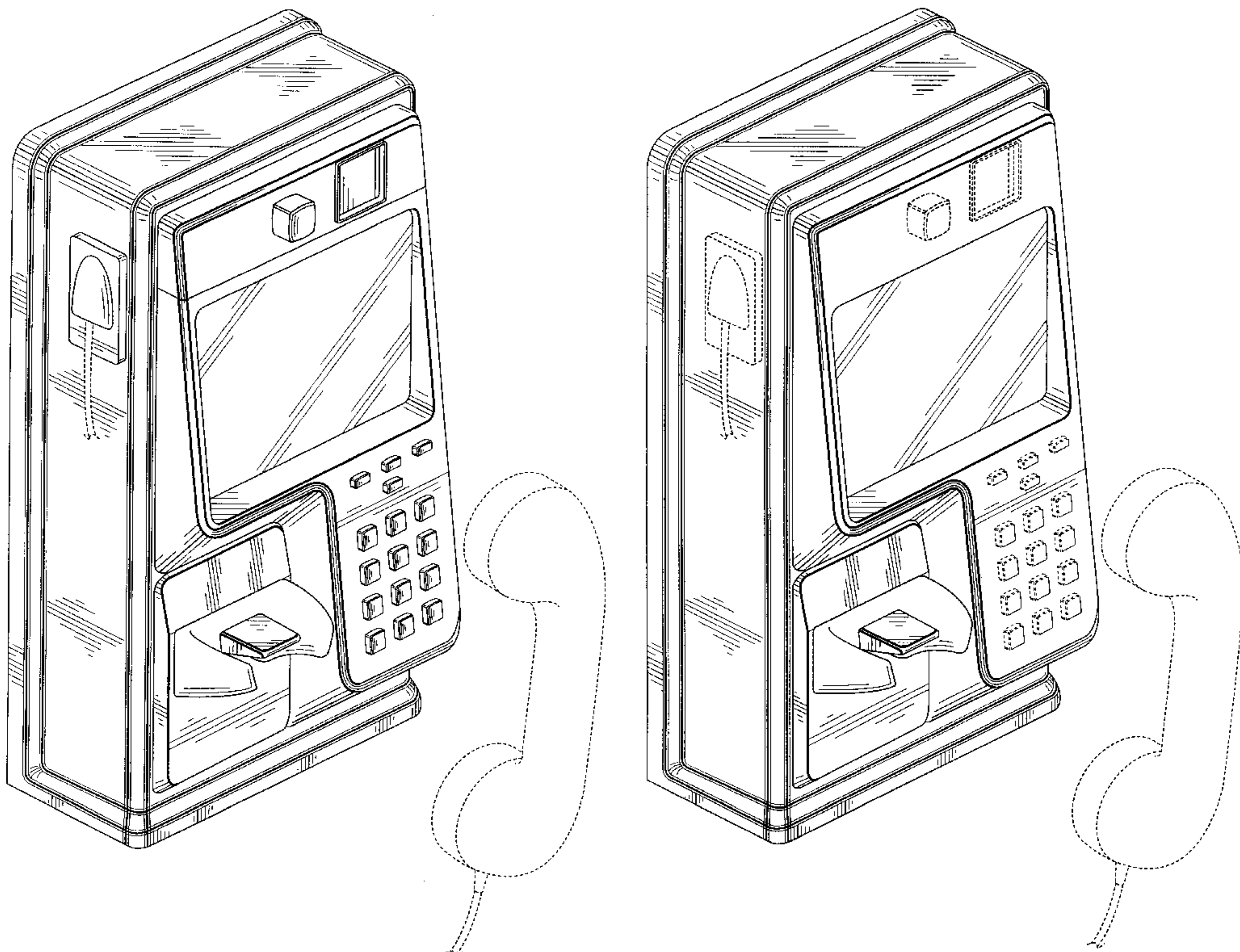

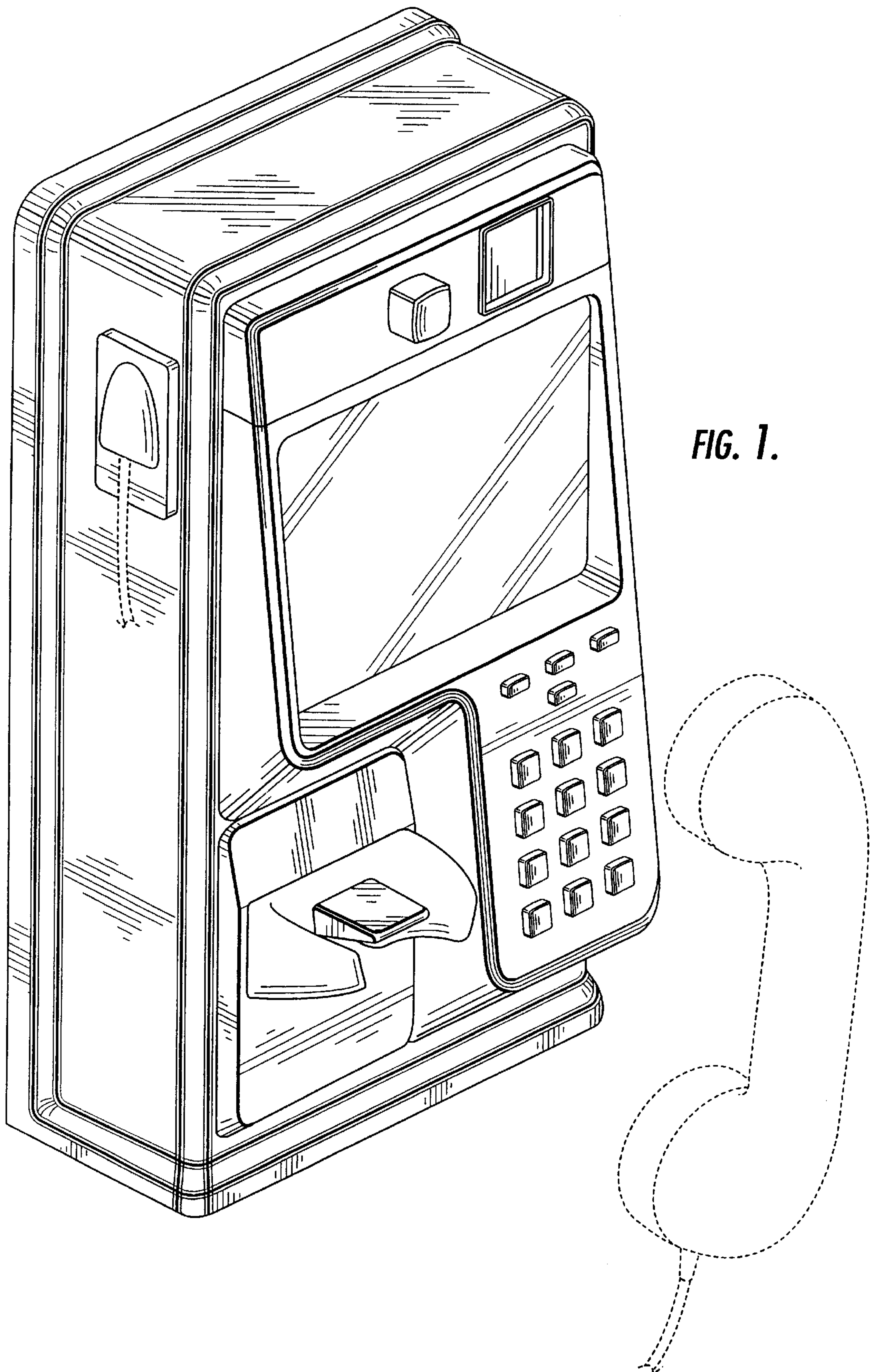

FIG. 1.

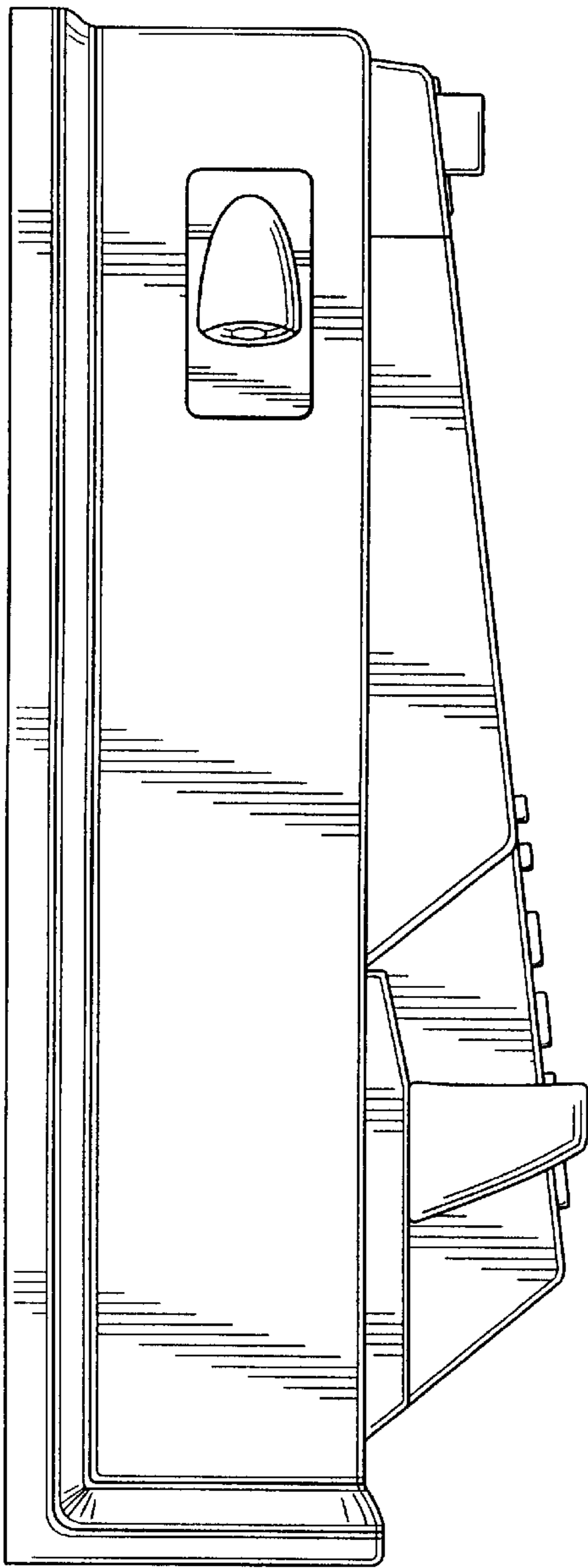

FIG. 2.

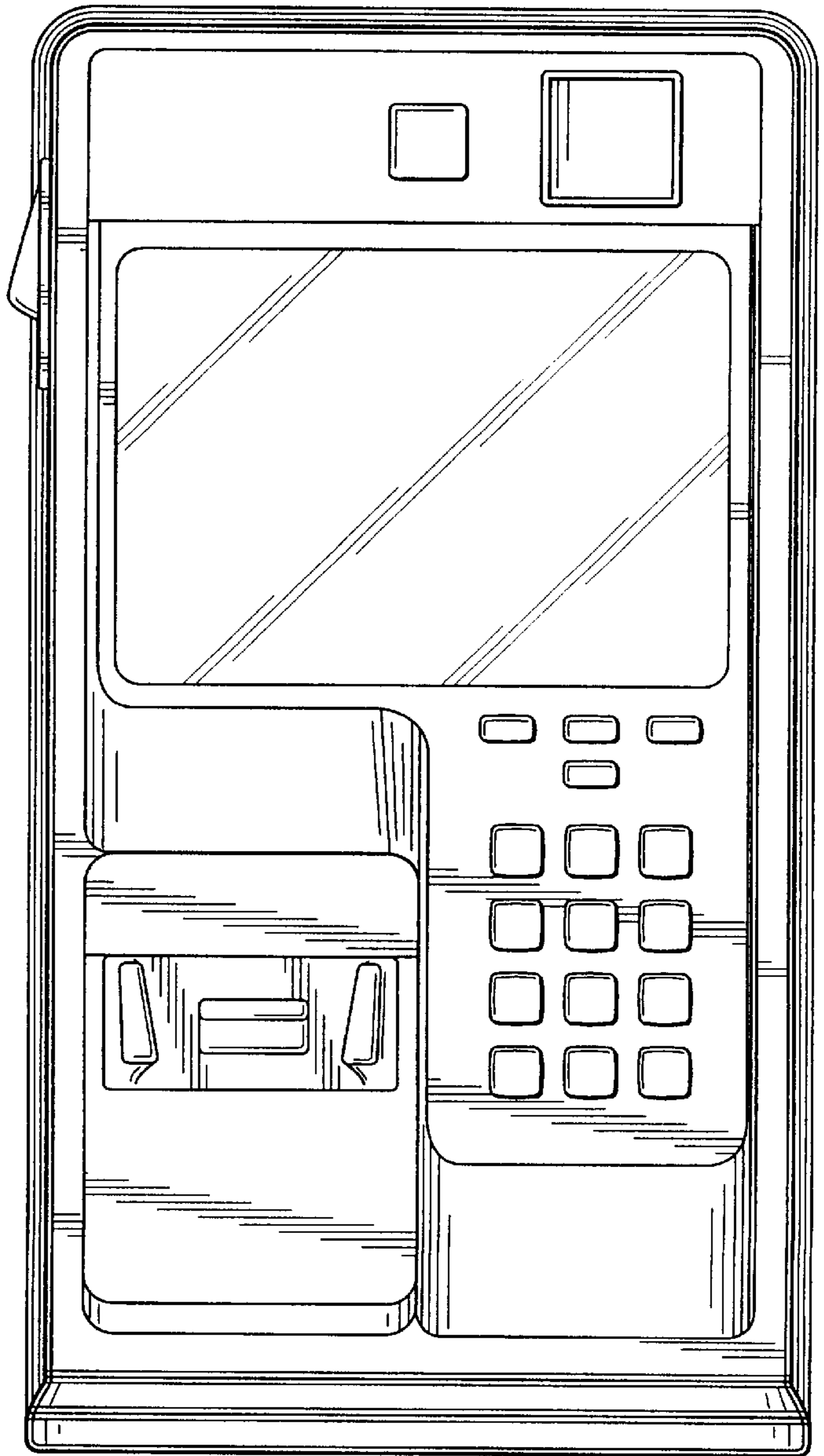

FIG. 3.

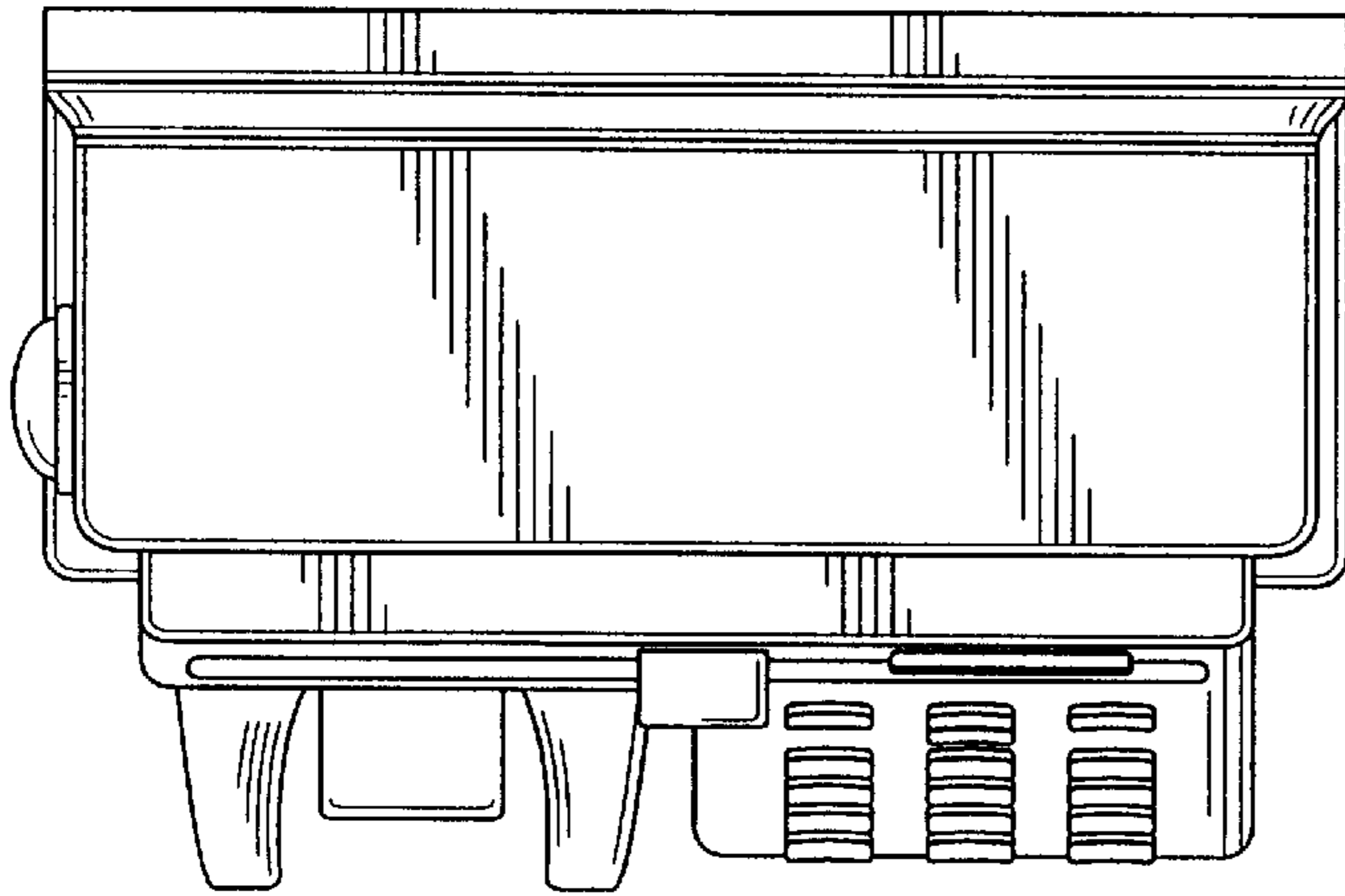

FIG. 4.

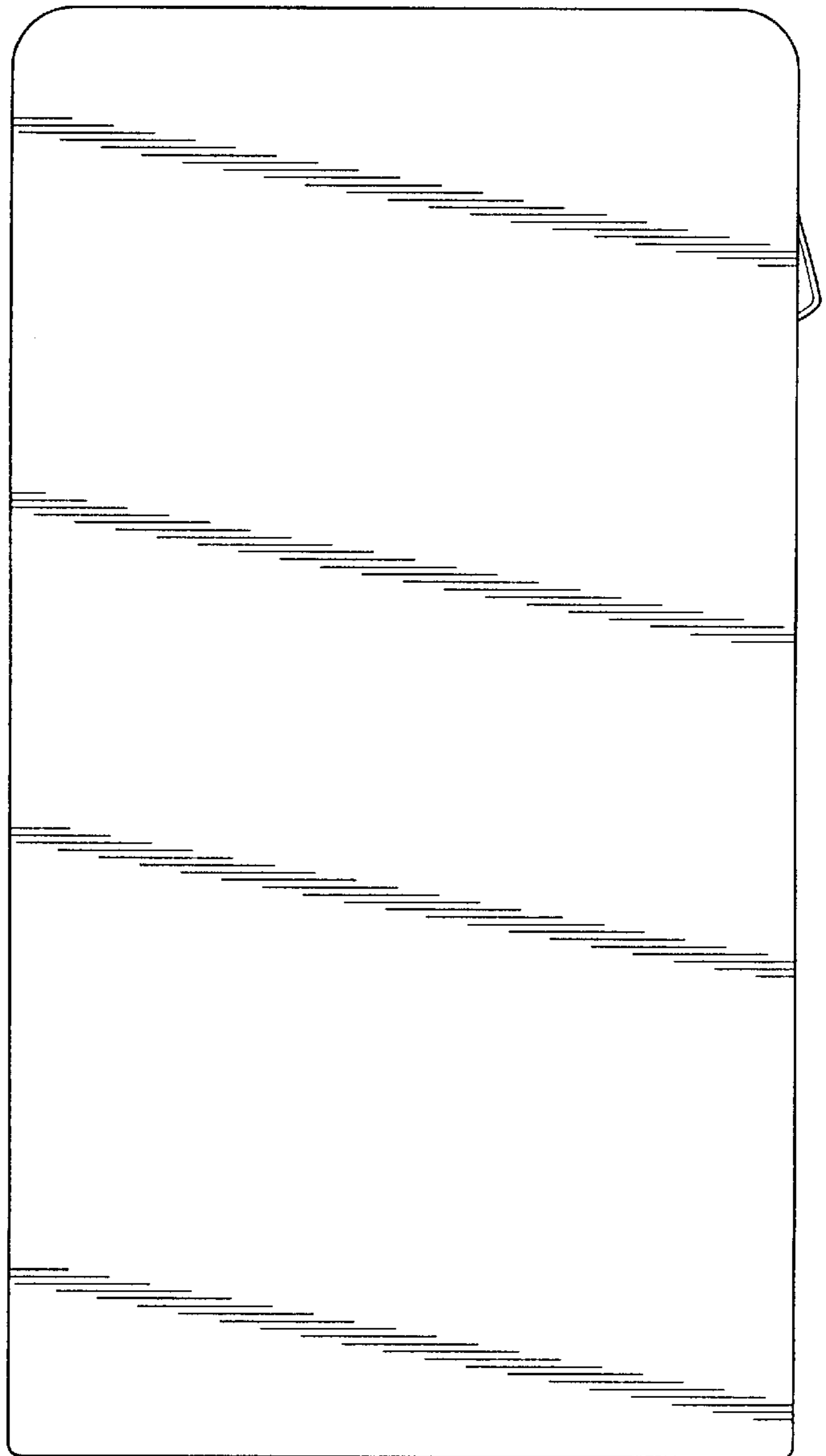

FIG. 5.

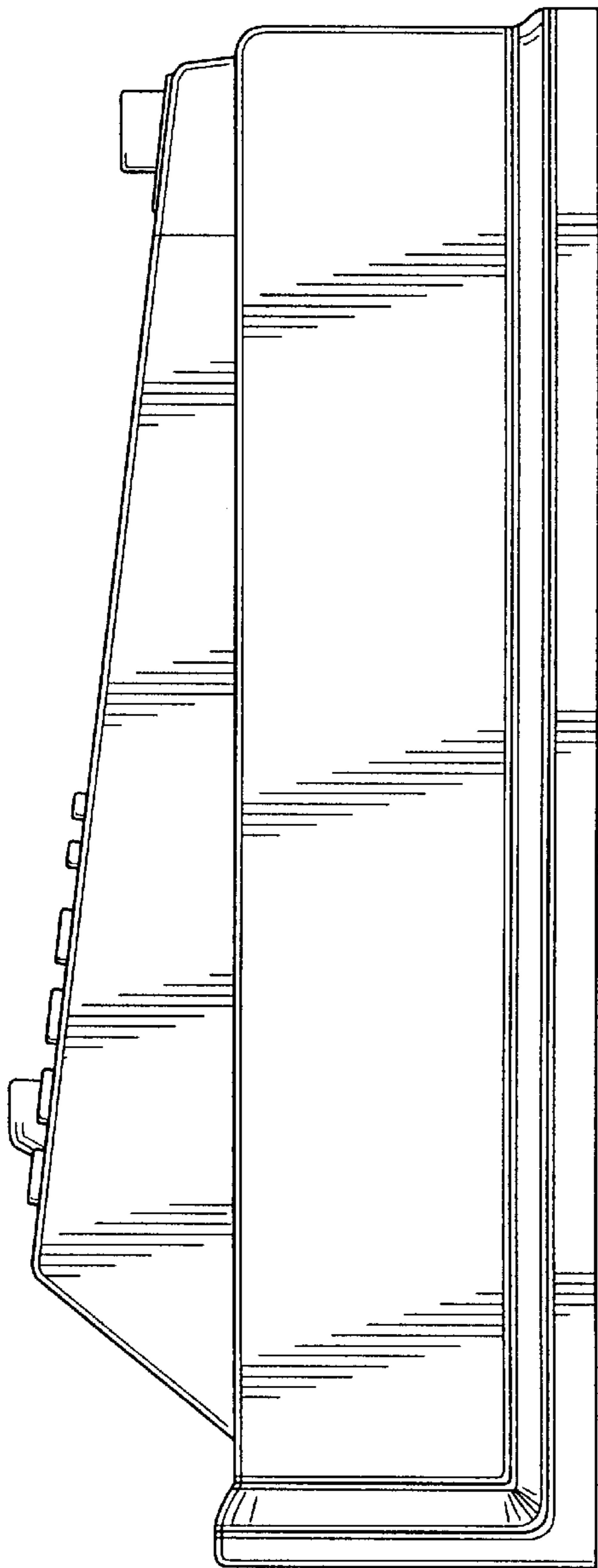

FIG. 6.

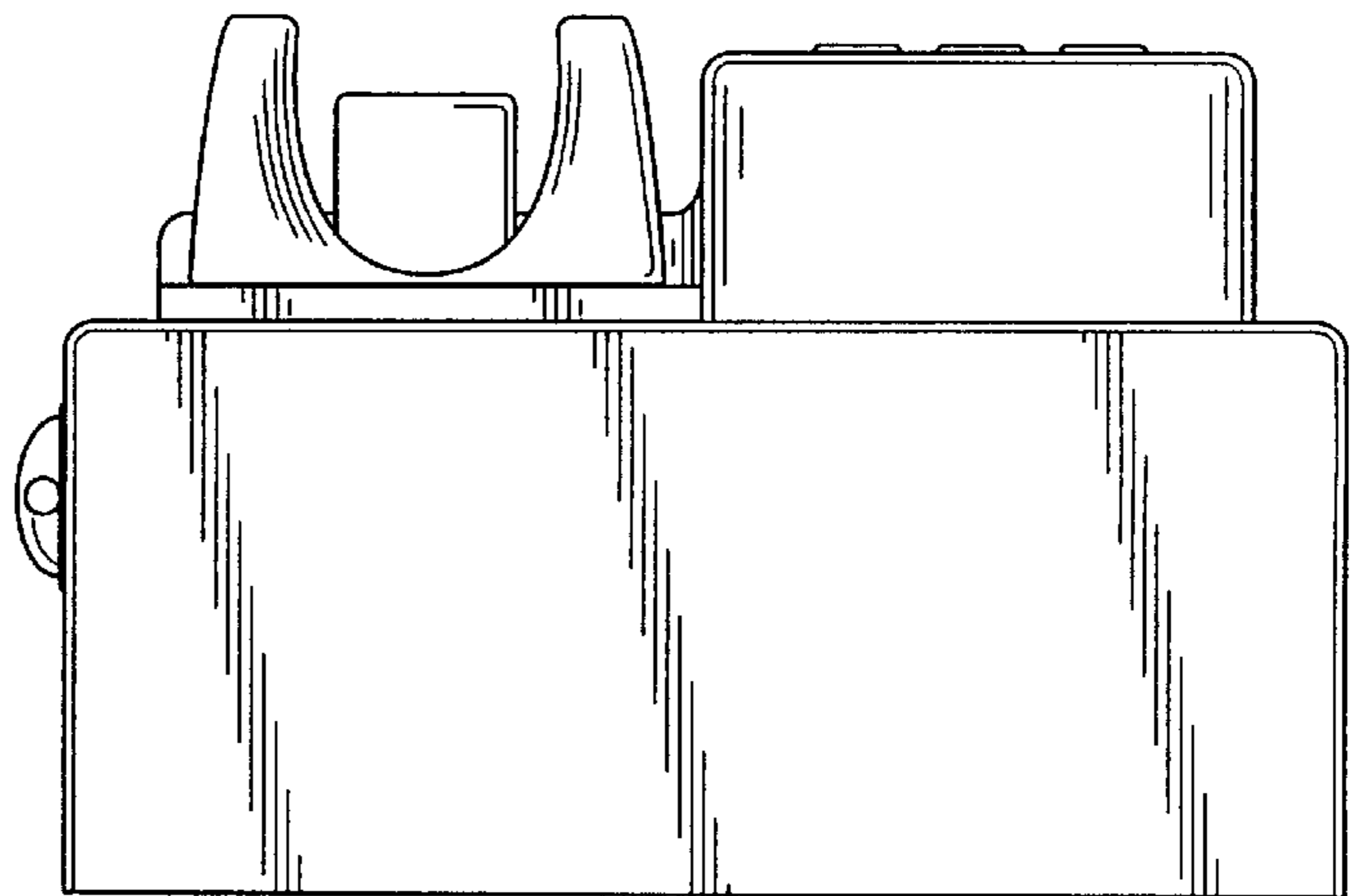

FIG. 7.

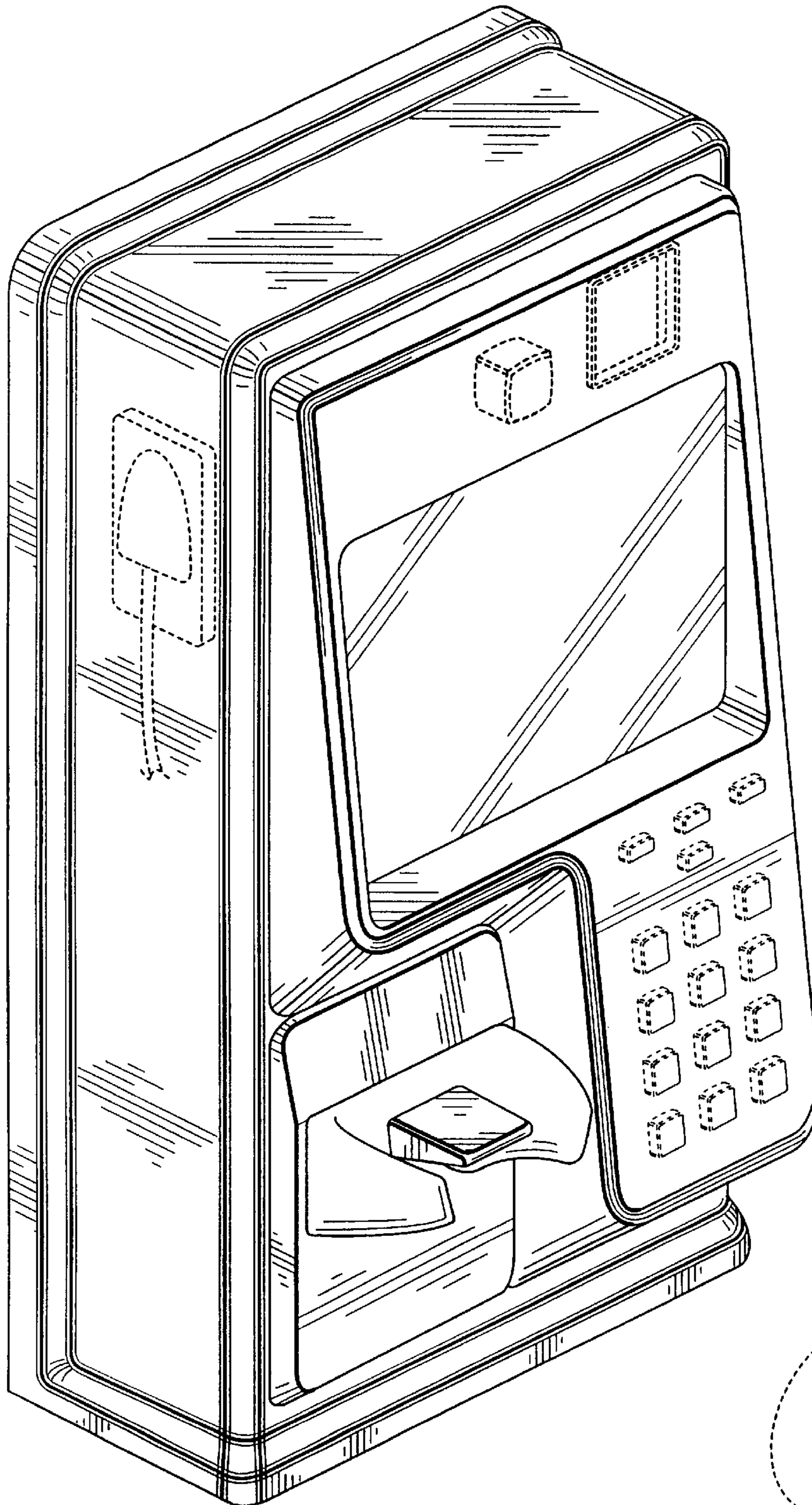
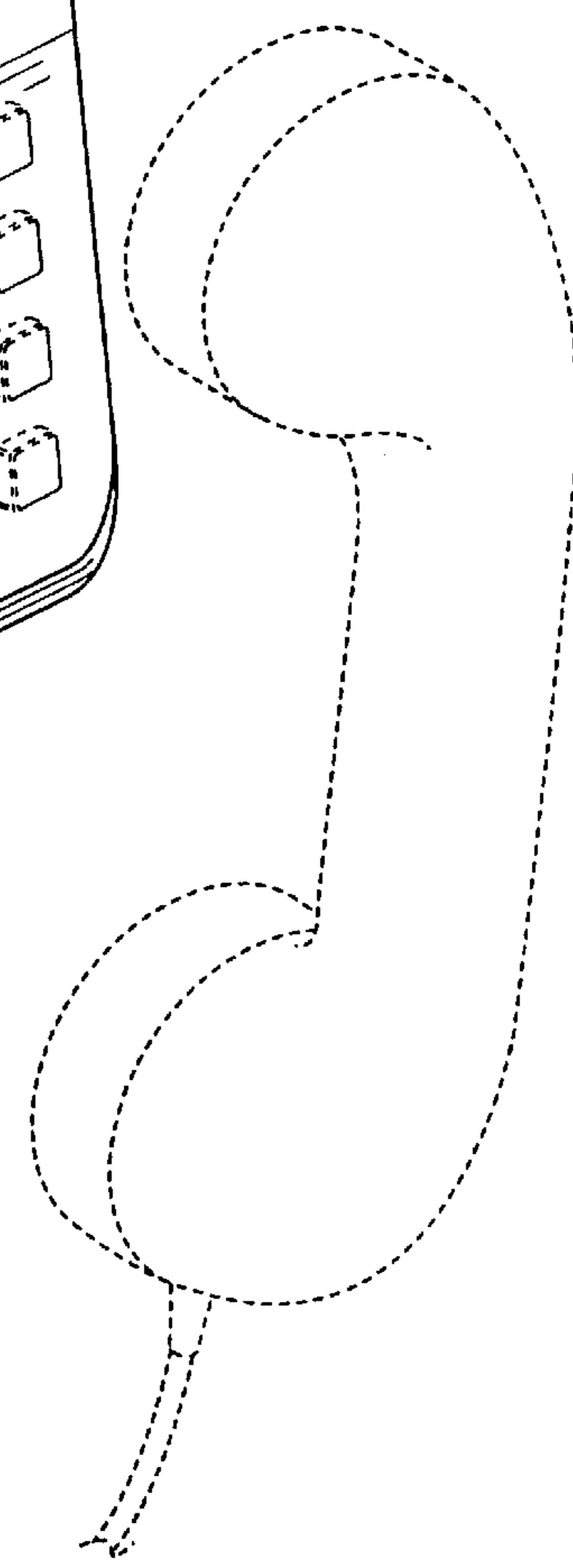

FIG. 8.



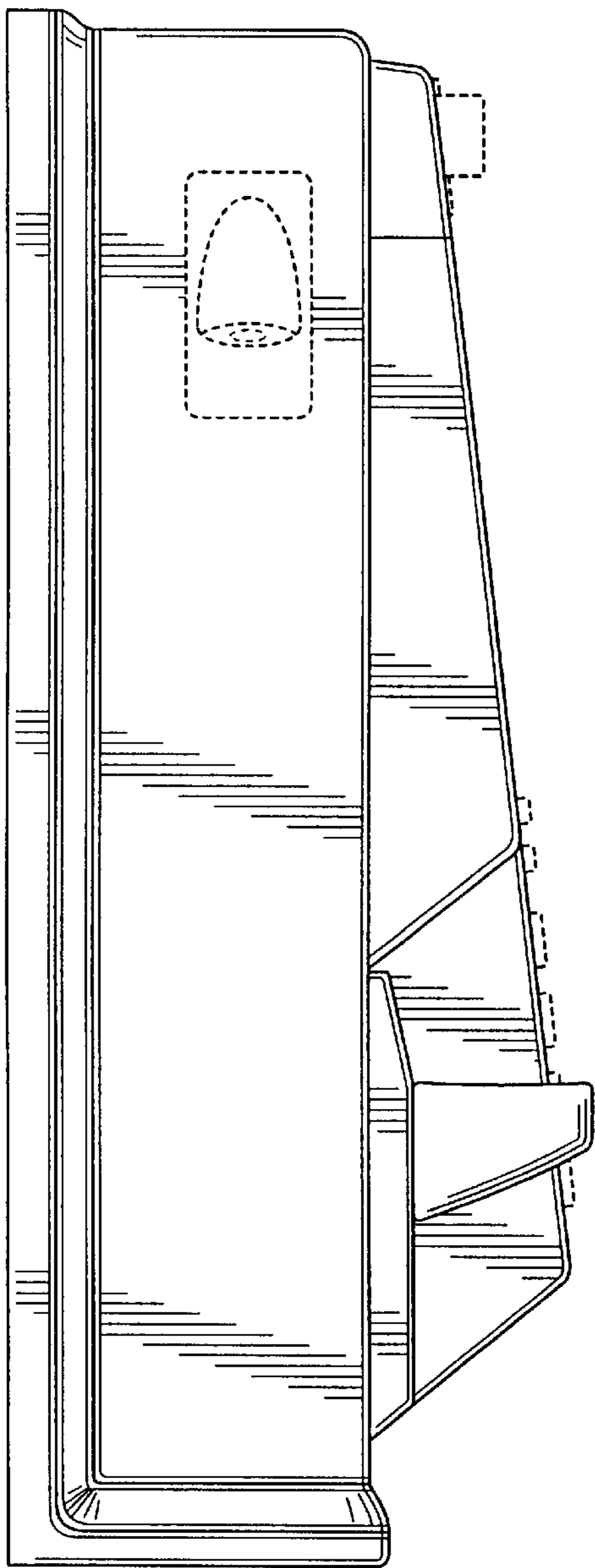

FIG. 9.

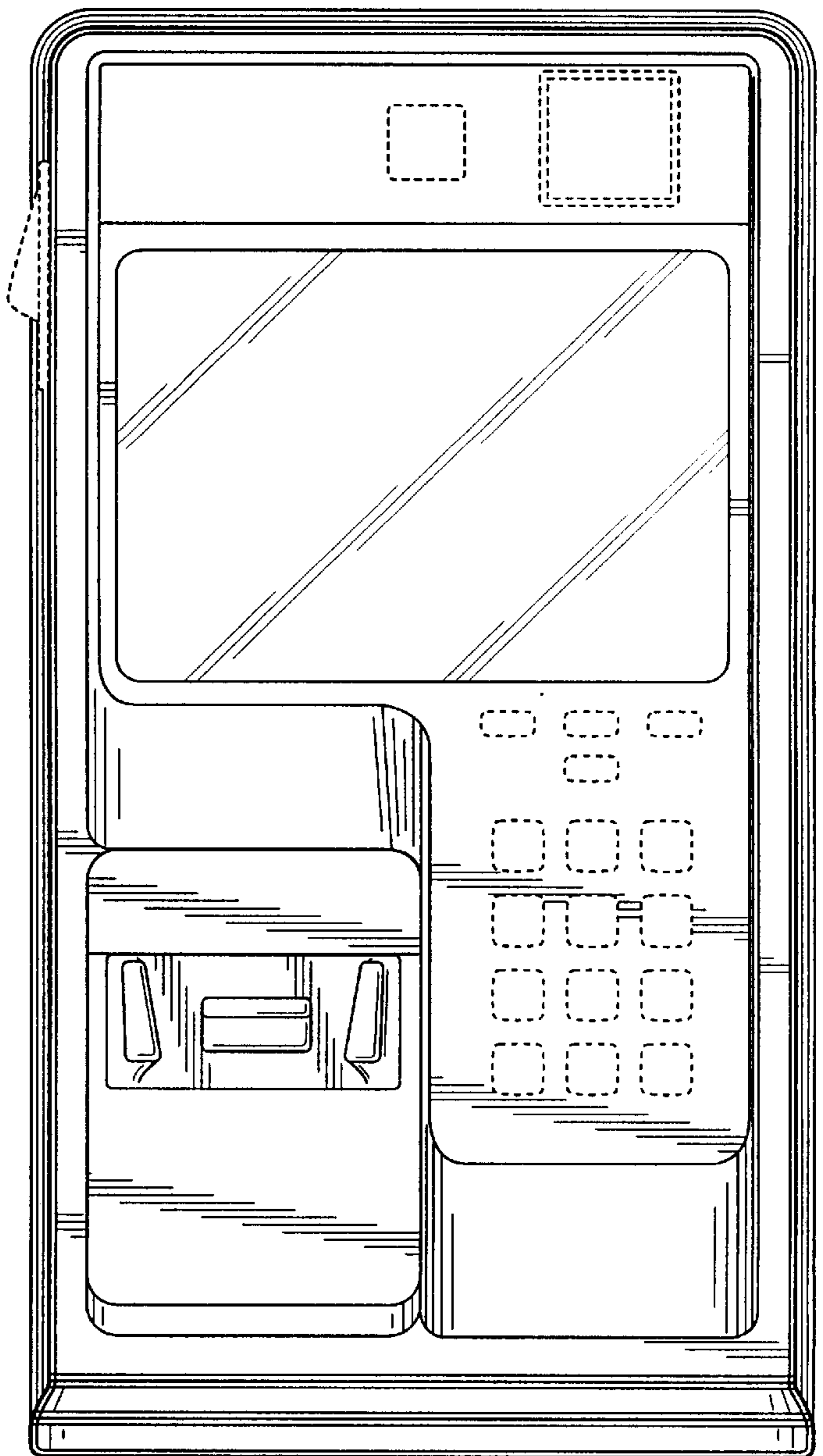

FIG. 10.

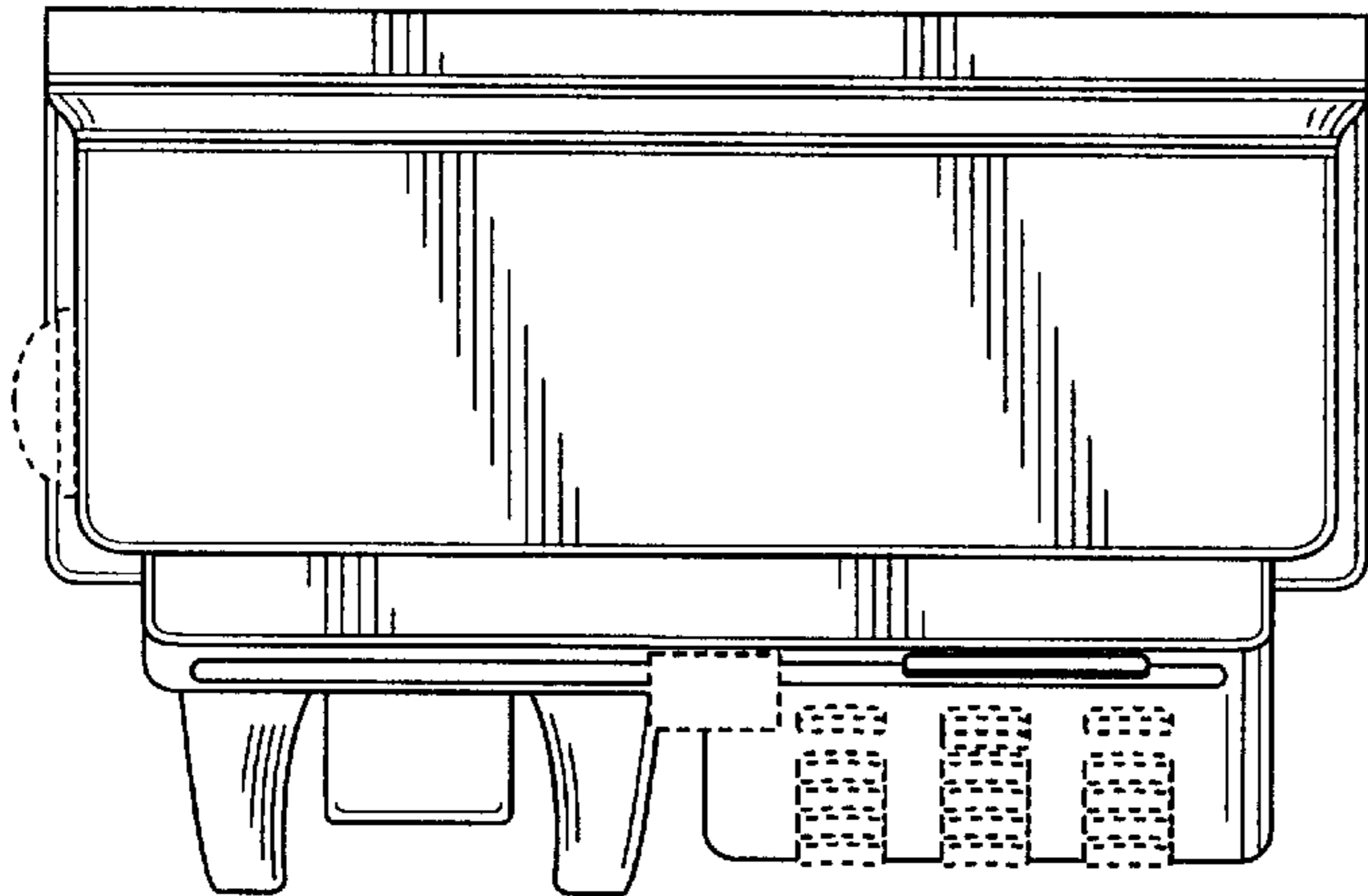

FIG. 11.

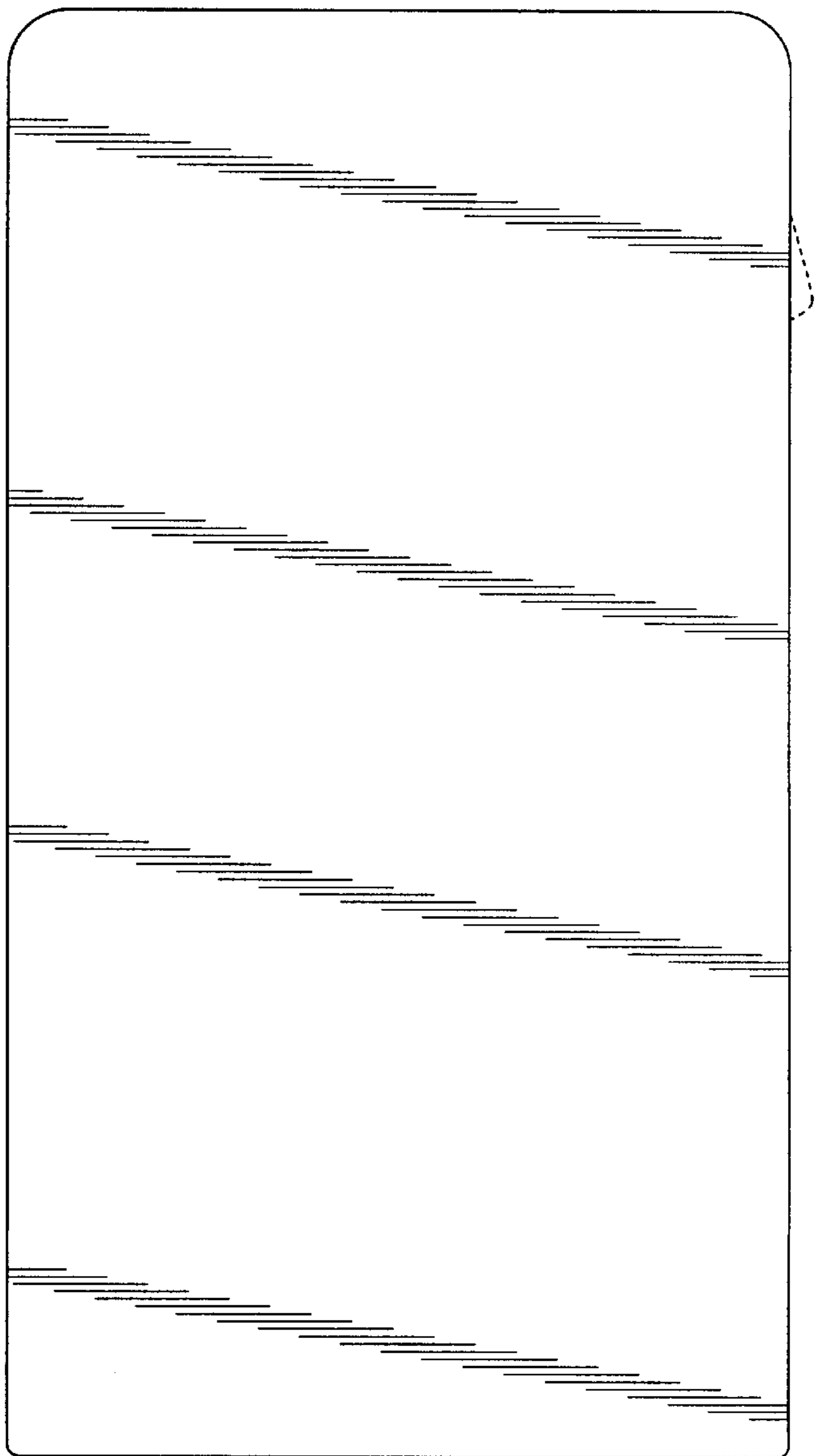

FIG. 12.

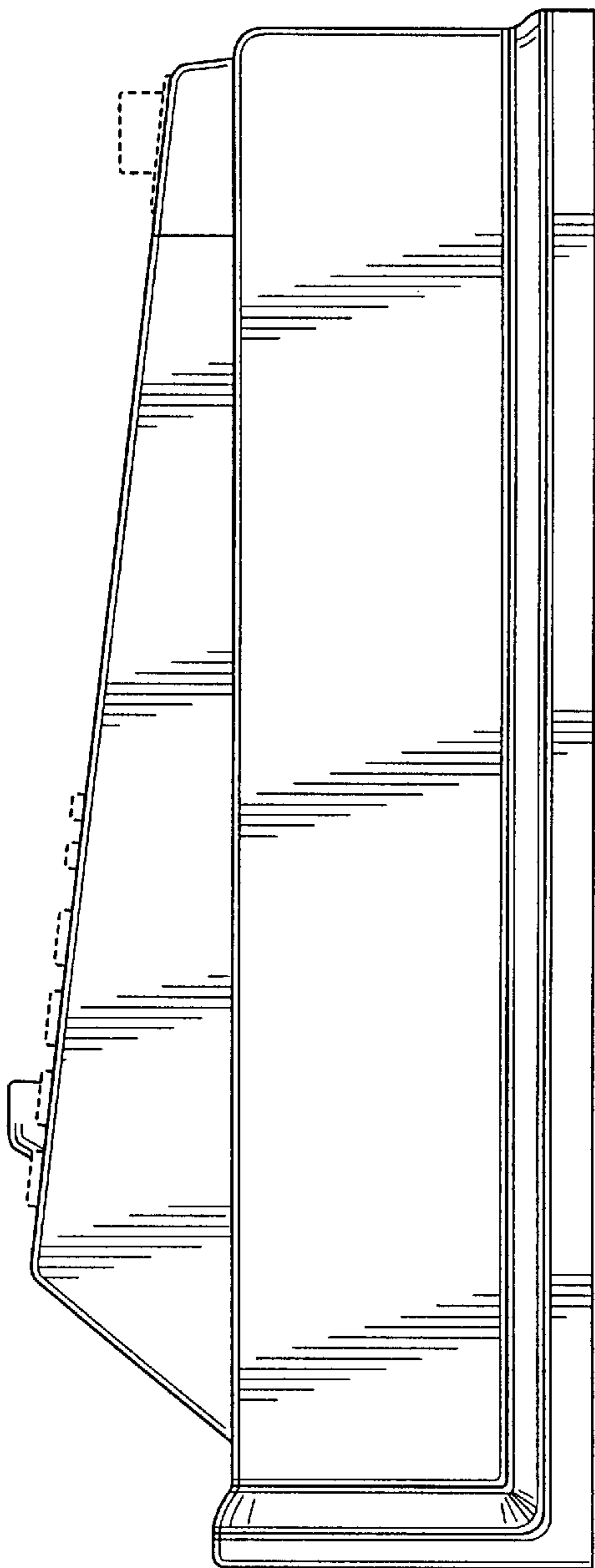

FIG. 13.

FIG. 14.

