



US00D429668S

# United States Patent [19] Julian

[11] **Patent Number: Des. 429,668**

[45] **Date of Patent: \*\* Aug. 22, 2000**

[54] **FOOTBALL HITCH PLUG WITH A DISPLAY SURFACE**

[76] Inventor: **Patrick M. Julian**, 3311 E. Harrison St., Seattle, Wash. 98112

[\*\*] Term: **14 Years**

[21] Appl. No.: **29/101,406**

[22] Filed: **Mar. 3, 1999**

[51] **LOC (7) Cl.** ..... **12-16**

[52] **U.S. Cl.** ..... **D12/162**

[58] **Field of Search** ..... D12/162, 183, D12/193, 400; D9/307, 441, 451; D23/260; D29/106; 40/200, 209, 591; 138/89, 89.1, 89.4; 211/14; 280/495, 490.1, 477, 506, 507, 511, 727, 769

[56] **References Cited**

**U.S. PATENT DOCUMENTS**

D. 298,105	10/1988	Lamantia, Jr.	.....	D9/307
D. 357,541	4/1995	Neidell	.....	D9/451
D. 369,996	5/1996	Wylie	.....	D12/162
D. 373,310	9/1996	Trautman	.....	D9/441
D. 383,979	9/1997	Tucker	.....	D9/451
D. 391,478	3/1998	D'Arrigo	.....	D9/307
D. 399,802	10/1998	Adelaar	.....	D12/162
D. 401,193	11/1998	Julian	.....	D12/162
D. 401,197	11/1998	Julian	.....	D12/162
D. 402,601	12/1998	Julian	.....	D12/162
D. 404,349	1/1999	Julian	.....	D12/162
D. 404,696	1/1999	Julian	.....	D12/162
D. 415,080	10/1999	Schultz	.....	D12/162
1,383,290	7/1921	Cressey	.....	D9/307 X

2,840,842	7/1958	Kaheny	.....	D9/307 X
3,624,939	12/1971	Gossard	.....	D9/307 X
4,164,284	8/1979	Witt et al.	.....	D9/307 X
5,715,947	2/1998	Gonzales	.....	211/14

*Primary Examiner*—Robert M. Spear  
*Attorney, Agent, or Firm*—Cooley Godward LLP

[57] **CLAIM**

The ornamental design for a football hitch plug with a display surface, as shown and described.

**DESCRIPTION**

FIG. 1 is a perspective view of a football hitch plug with a display surface showing my new design;  
 FIG. 2 is a front elevational view of the football hitch plug with a display surface;  
 FIG. 3 is a right side elevational view of the football hitch plug with a display surface;  
 FIG. 4 is a top plan view of the football hitch plug with a display surface and a bottom view of the football hitch plug with a display surface as the bottom and top views are identical;  
 FIG. 5 is a rear elevational view of the football hitch plug with a display surface; and,  
 FIG. 6 is a perspective view, shown at a reduced scale, of the football hitch plug with a display surface mounted on the hitch of a vehicle.

The broken line showing a decal with a logo is for illustrative purposes only and forms no part of the claimed design. Additionally, the broken line showing a vehicle is for illustrative purposes only and forms no part of the claimed design.

**1 Claim, 2 Drawing Sheets**

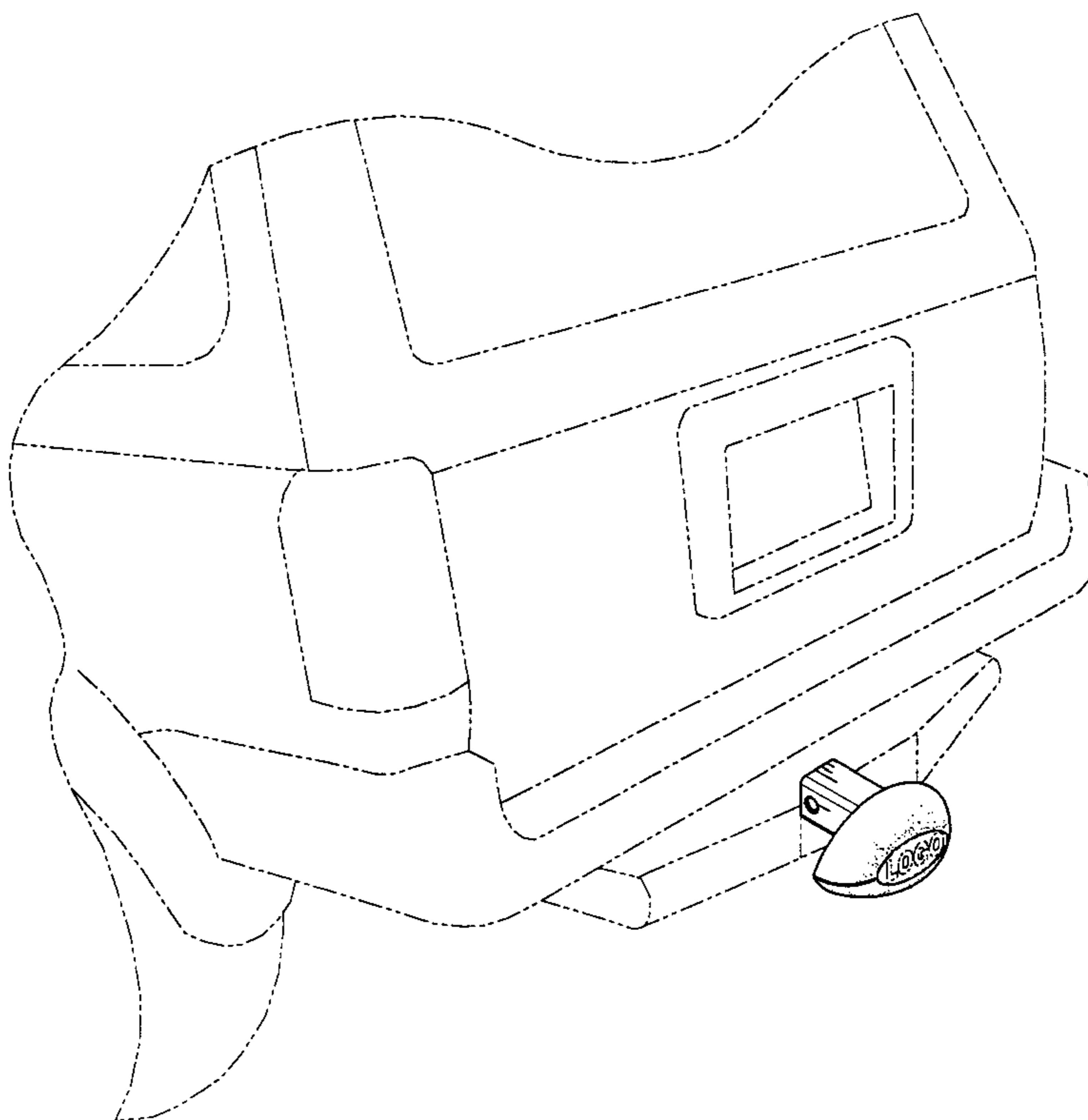

FIG. 4

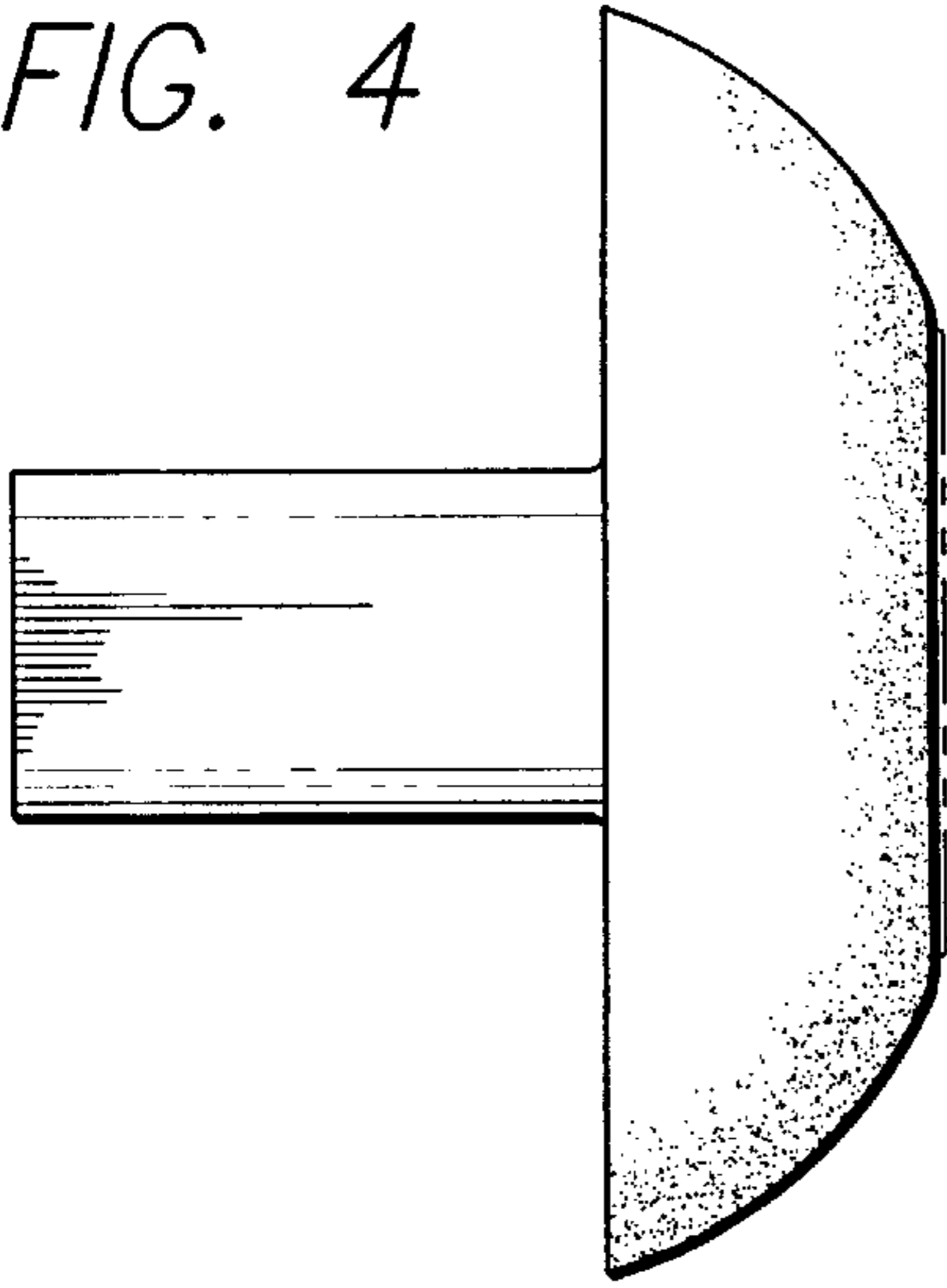

FIG. 5

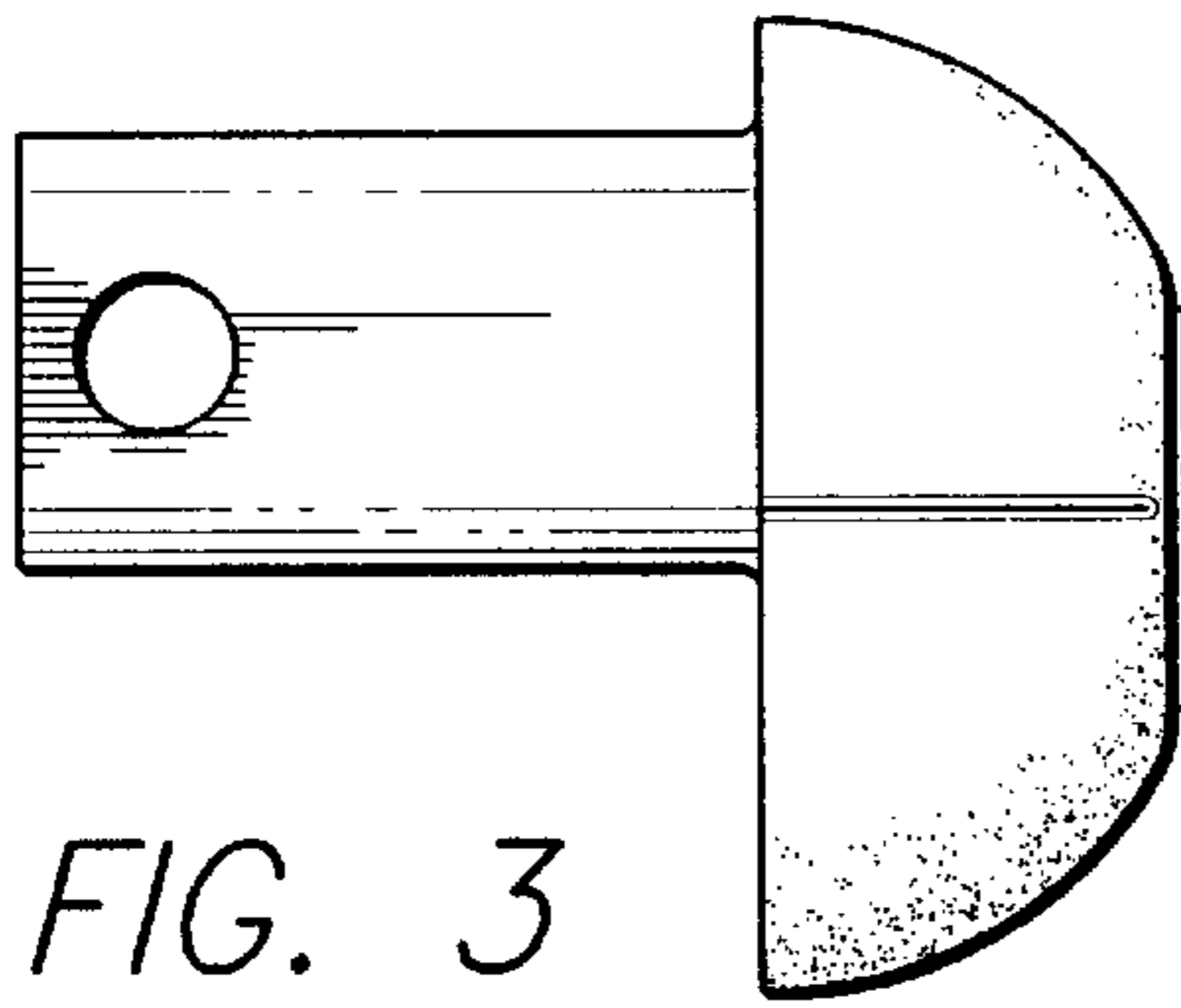
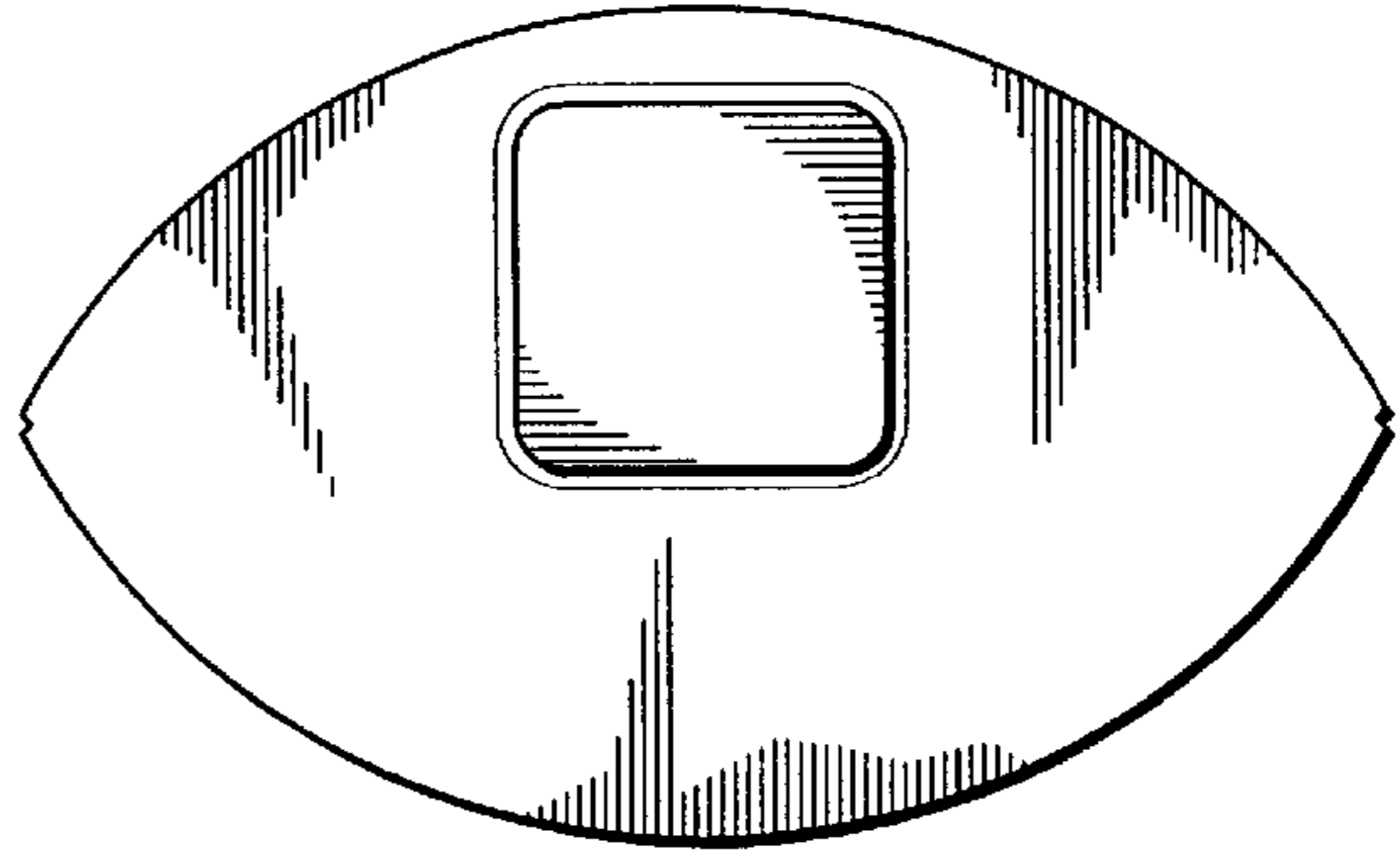

FIG. 3

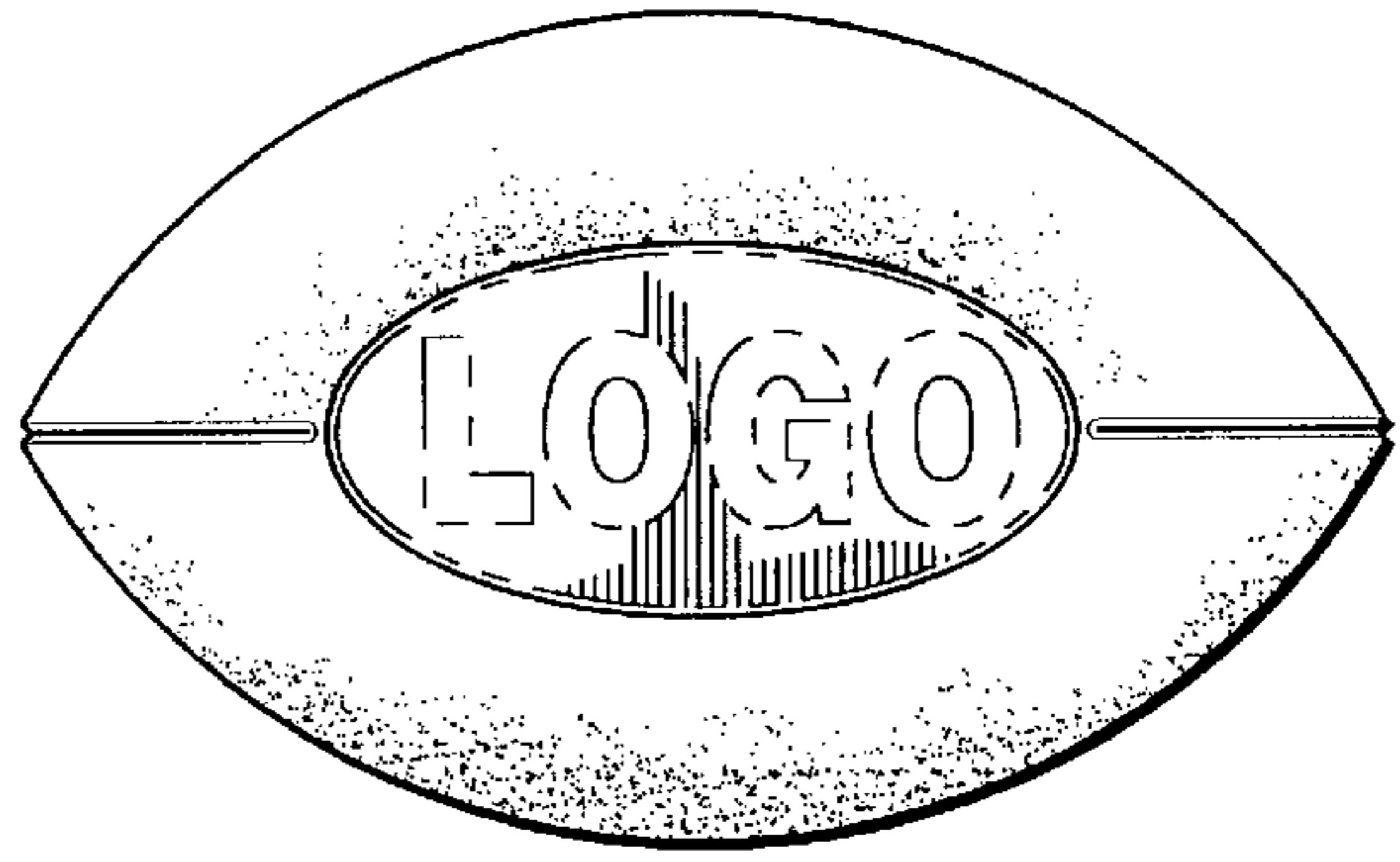

FIG. 2

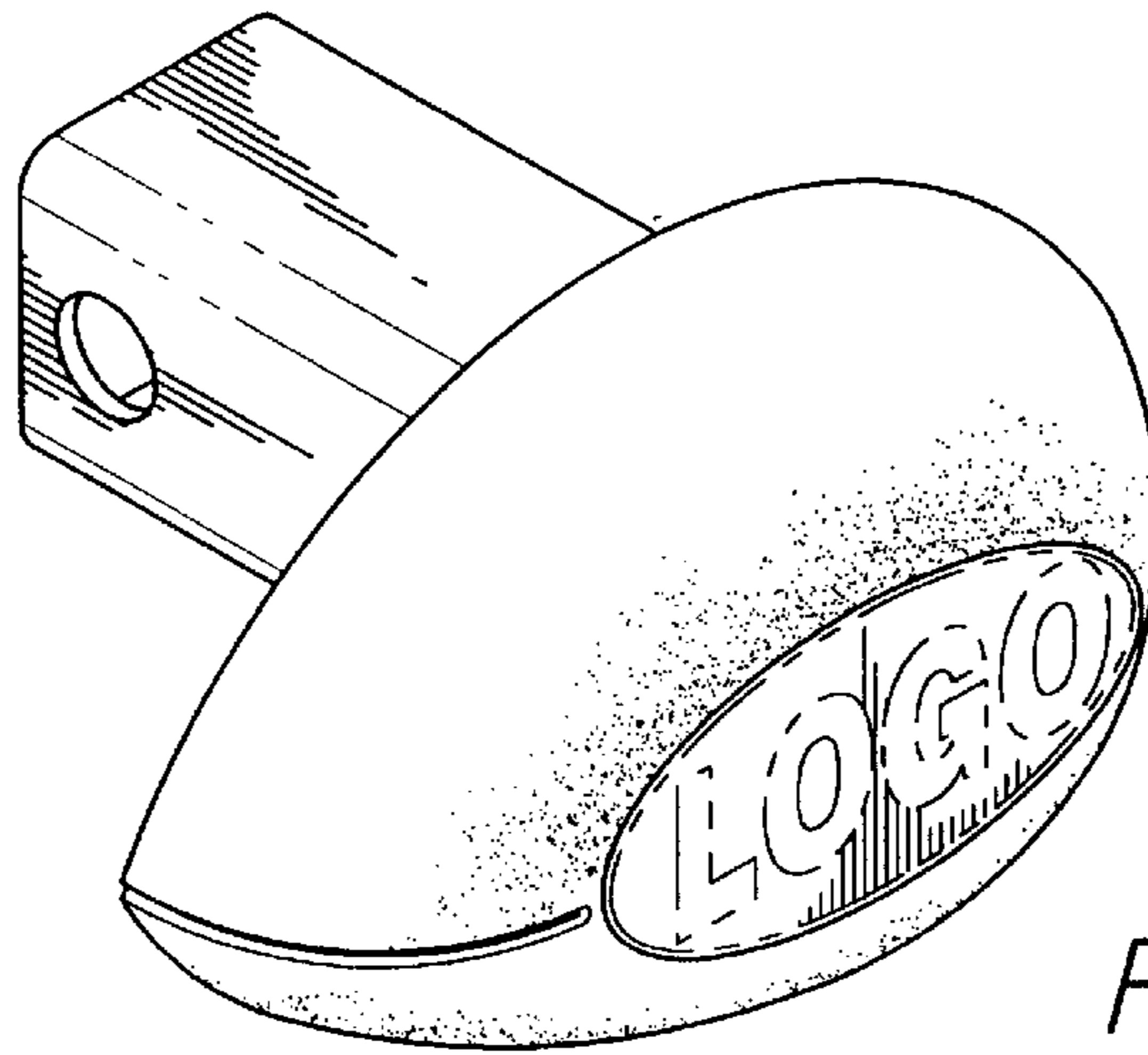

FIG. 1

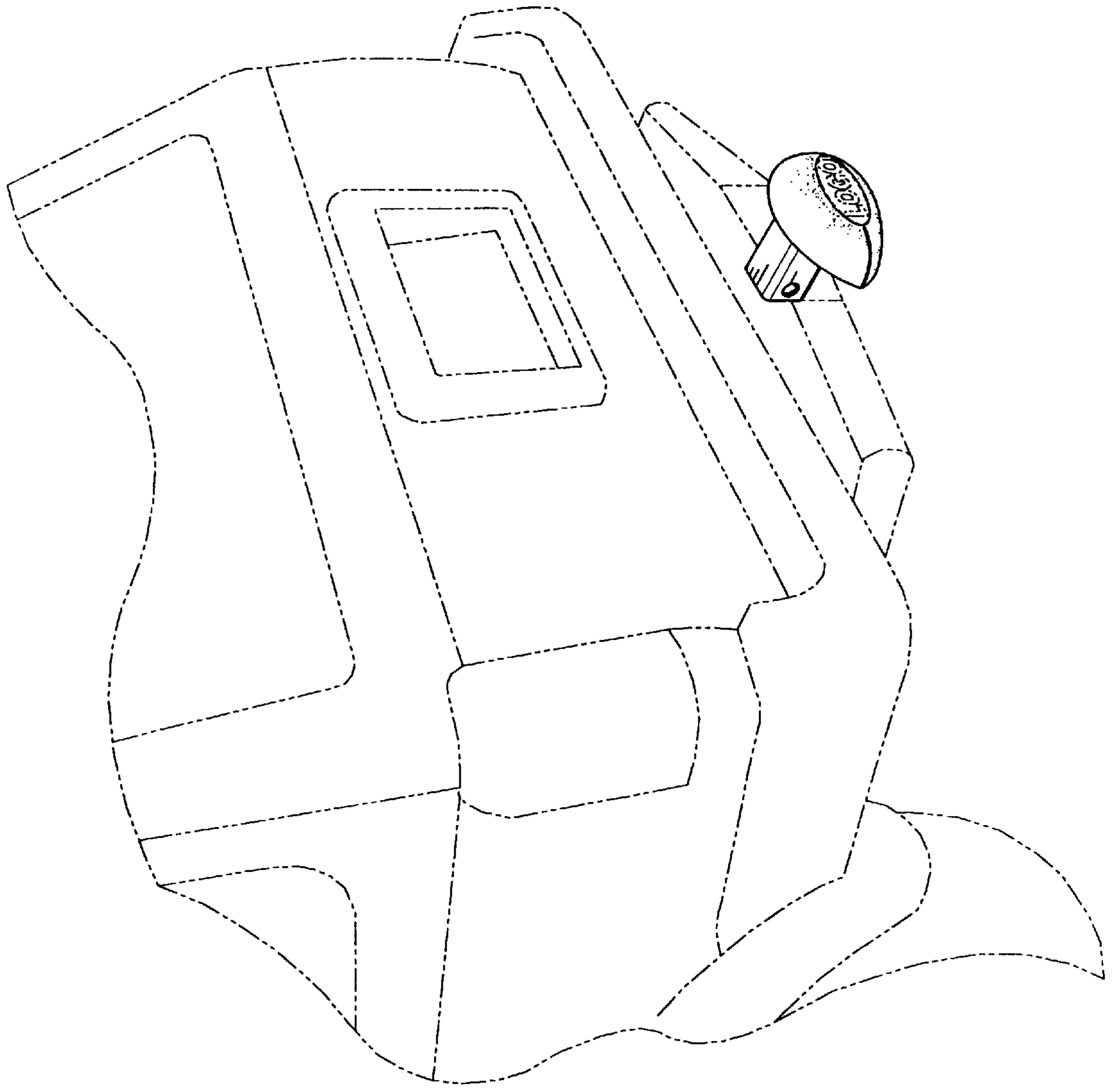

FIG. 6