



US00D429470S

United States Patent [19]
Hackenbroich

[11] **Patent Number: Des. 429,470**

[45] **Date of Patent: ** Aug. 15, 2000**

[54] **SHIELDING BOX**

5,811,050 7/1998 Gabower 264/299

[75] Inventor: **Wilfried Hackenbroich**, Holzkirchen,
Germany

Primary Examiner—Antoine Duval Davis

[73] Assignee: **Wavetek GmbH**, Ismaning, Germany

[57] **CLAIM**

[**] Term: **14 Years**

The ornamental design for a shielding box, as shown and described.

[21] Appl. No.: **29/111,213**

DESCRIPTION

[22] Filed: **Sep. 24, 1999**

FIG. 1 is a top view in plan of a shielding box showing my new design;

[30] **Foreign Application Priority Data**

FIG. 2 is a bottom view in plan thereof;

Mar. 26, 1999 [DE] Germany 4 99 03 284

FIG. 3 is a right side view in elevation thereof;

[51] **LOC (7) Cl.** **10-04**

FIG. 4 is a left side view in elevation thereof;

[52] **U.S. Cl.** **D10/46**

FIG. 5 is a front view in elevation thereof;

[58] **Field of Search** D10/46; 361/816,
361/741, 742, 752, 753, 756, 759, 796,
799, 801, 802, 814, 818; 264/299, 291,
293, 294

FIG. 6 is a rear view in elevation thereof;

FIG. 7 is a perspective view of the shielding box showing the front, top and left sides thereof; and,

[56] **References Cited**

FIG. 8 is a perspective view of the inside of the shielding box when the shielding box is opened by lifting the top portion thereof.

U.S. PATENT DOCUMENTS

5,777,856 7/1998 Phillips et al. 361/816

1 Claim, 2 Drawing Sheets

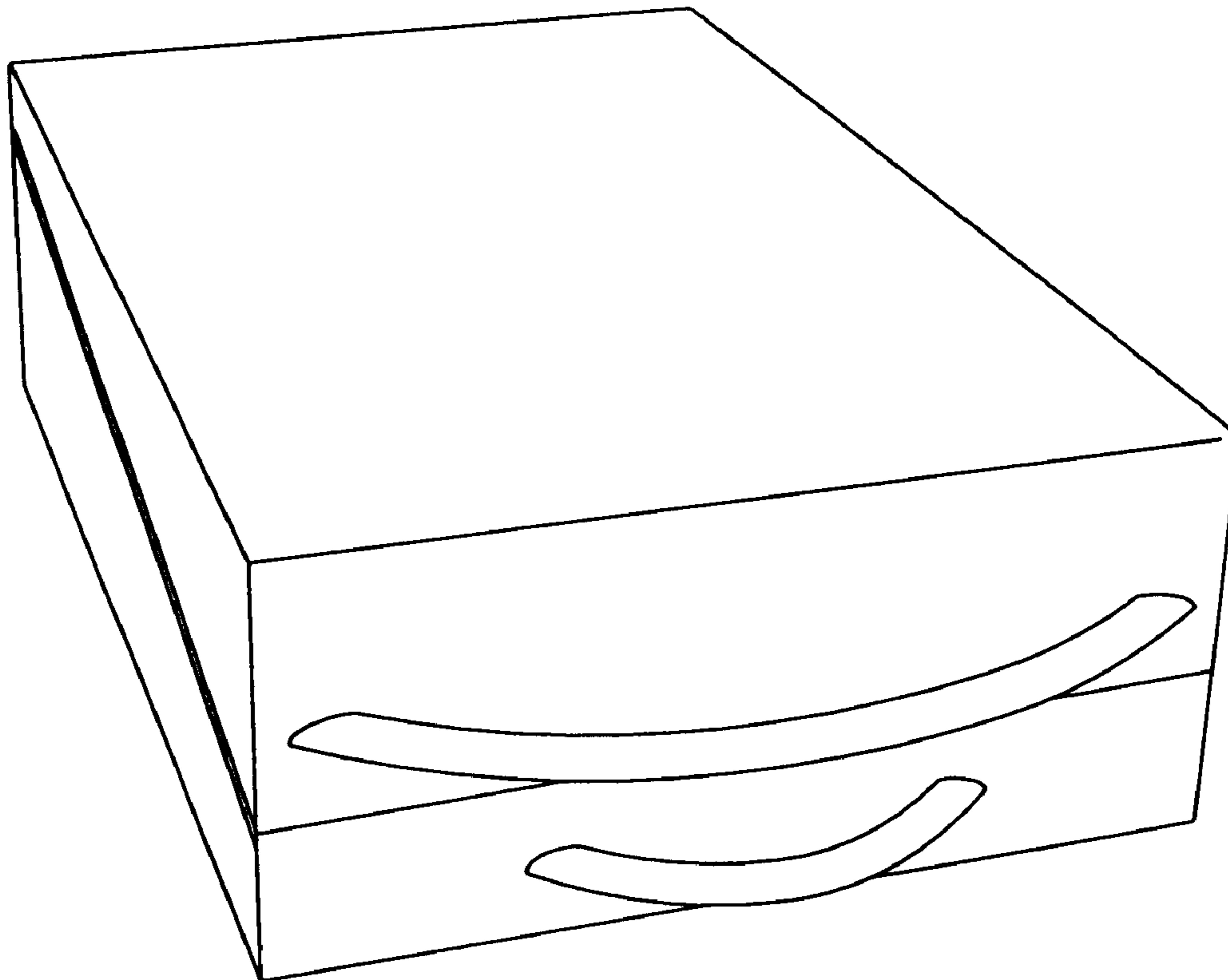

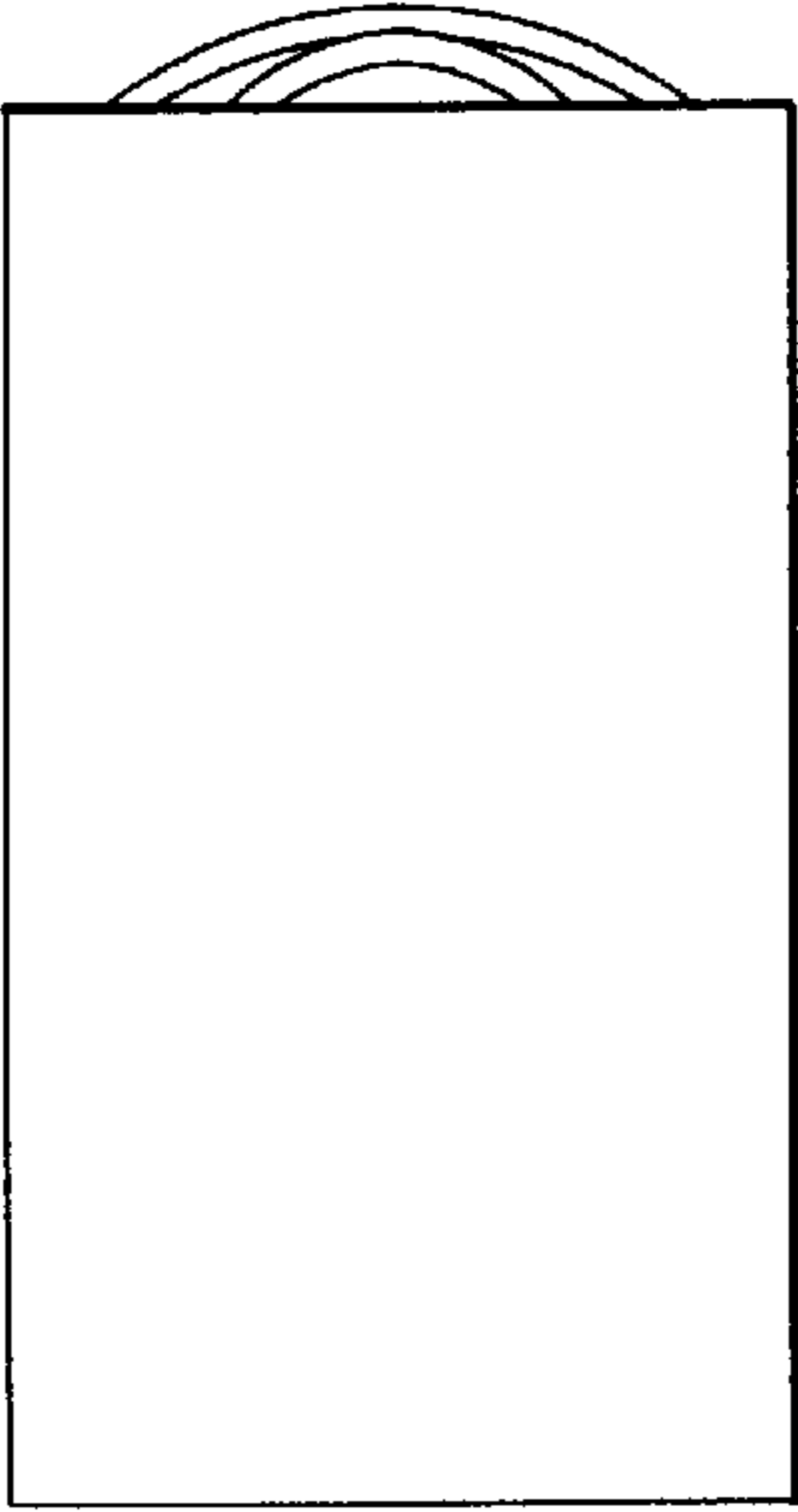

FIG. 1

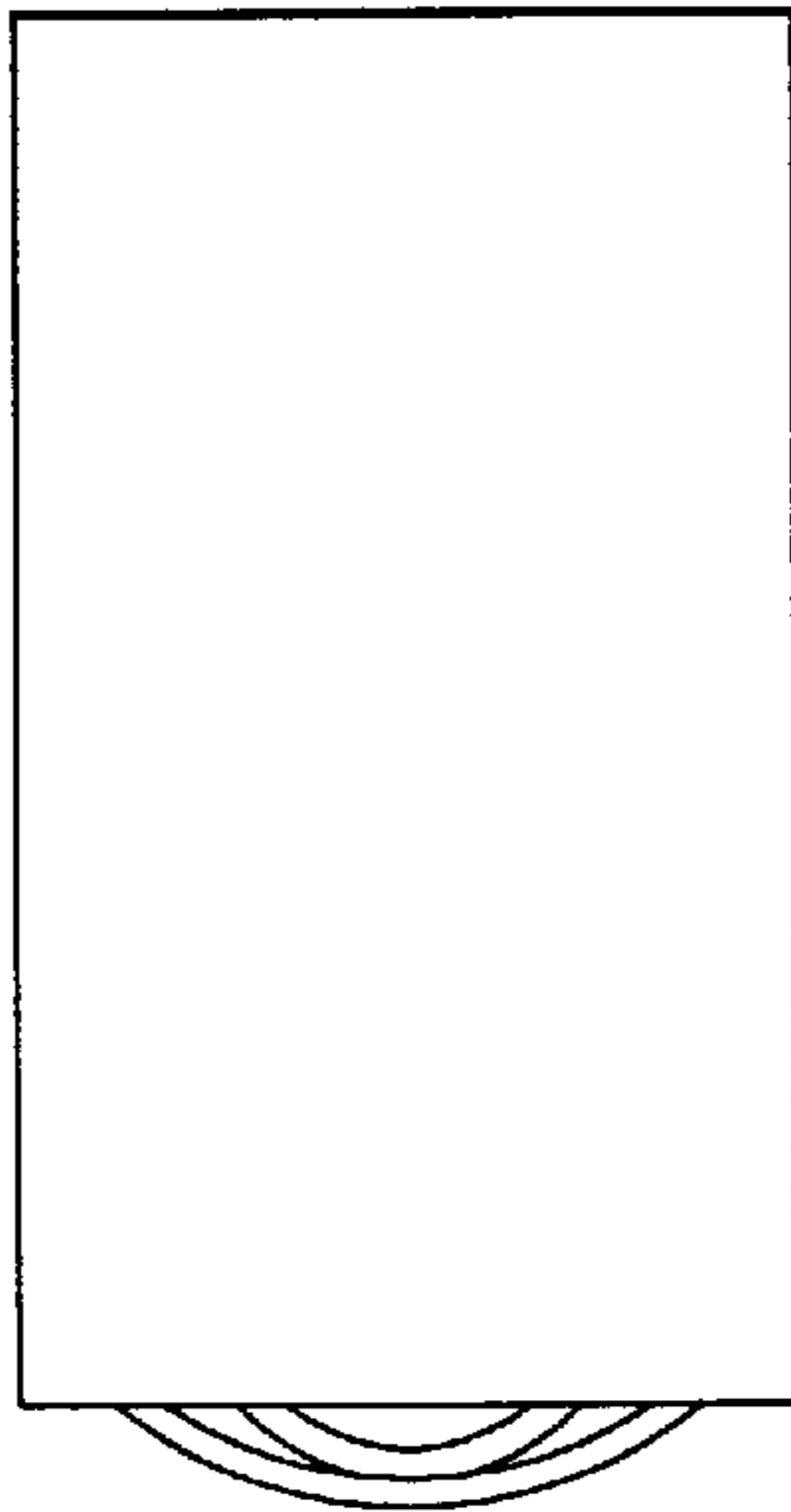

FIG. 2

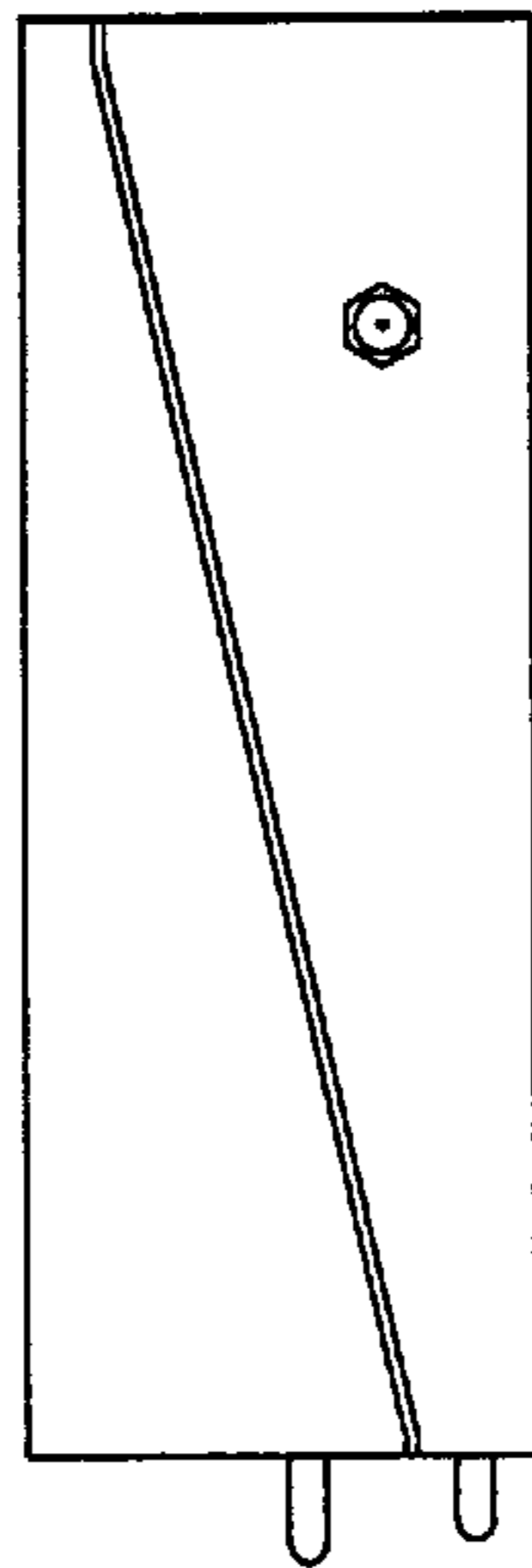

FIG. 3

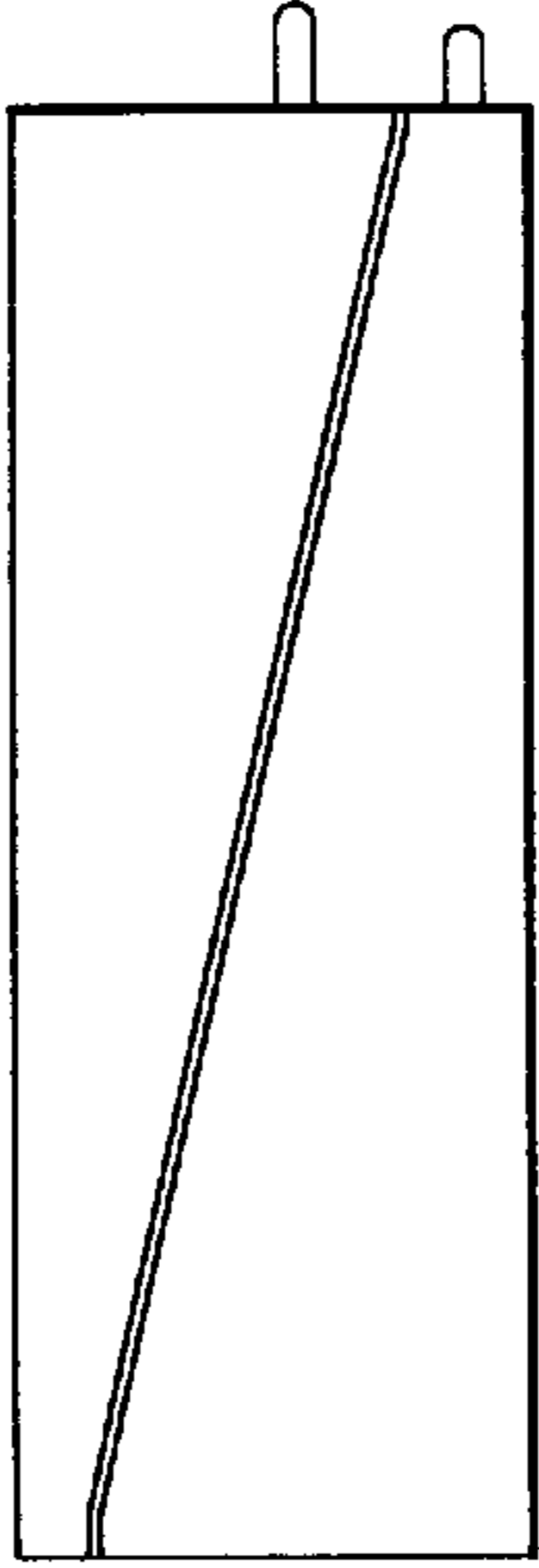

FIG. 4

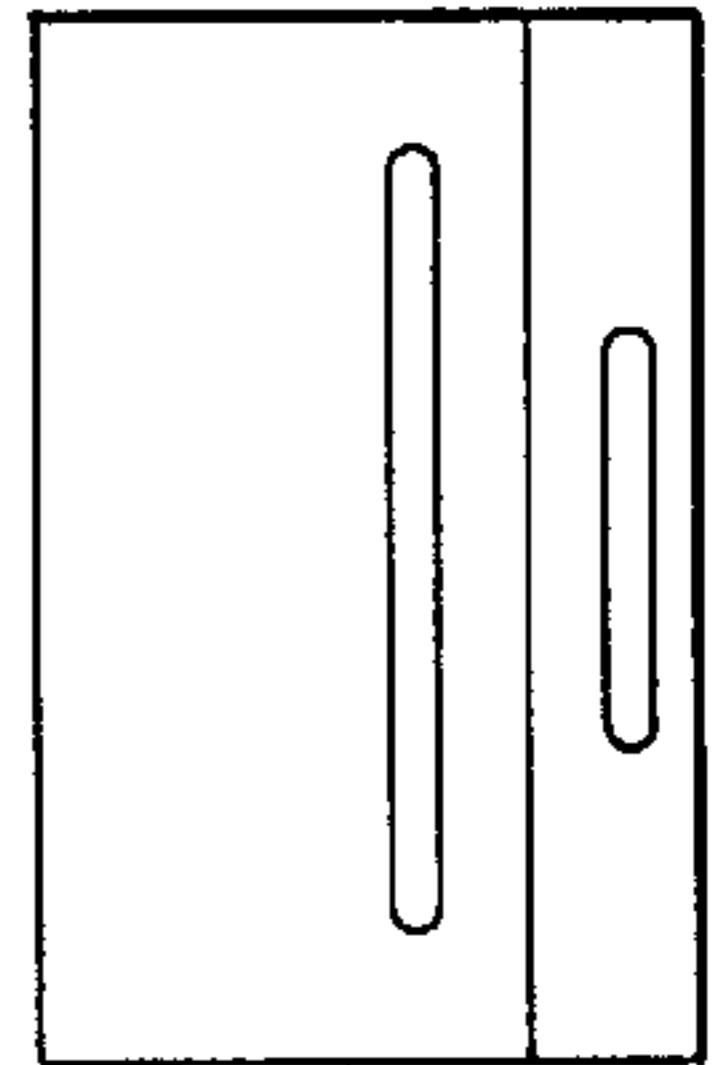

FIG. 5

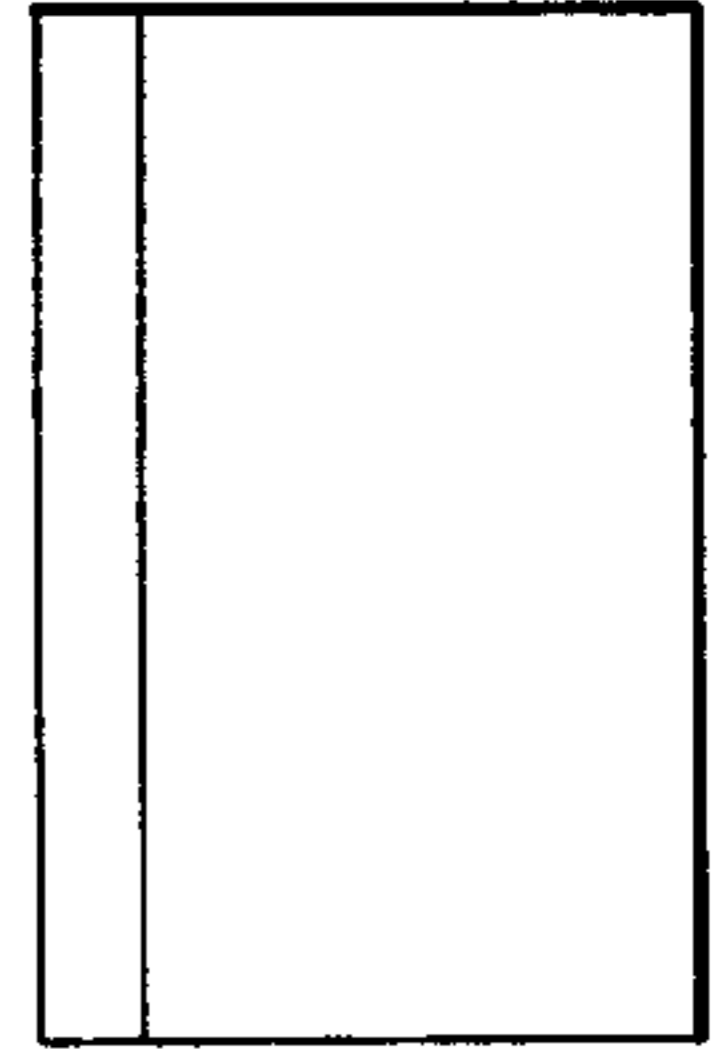

FIG. 6

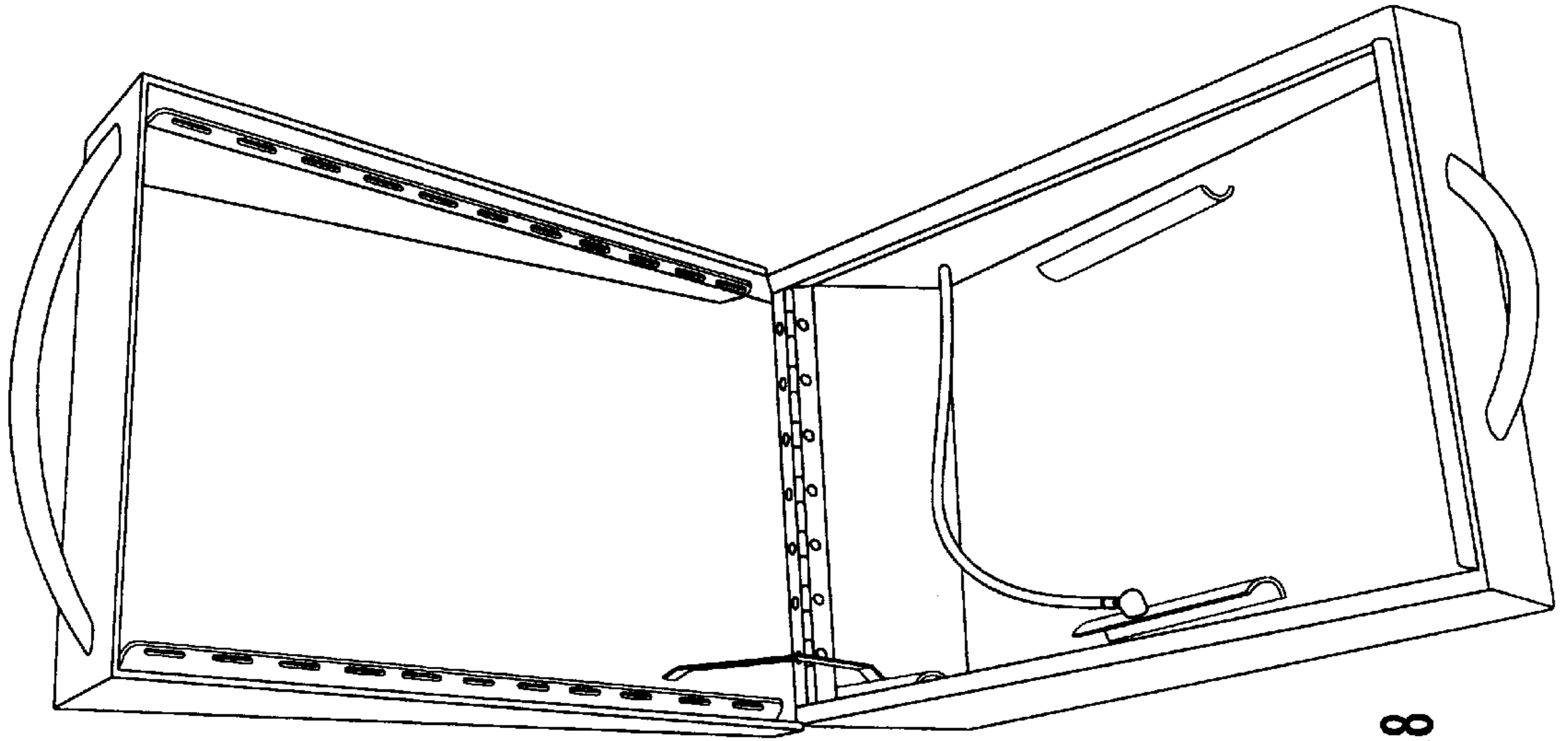

FIG. 8

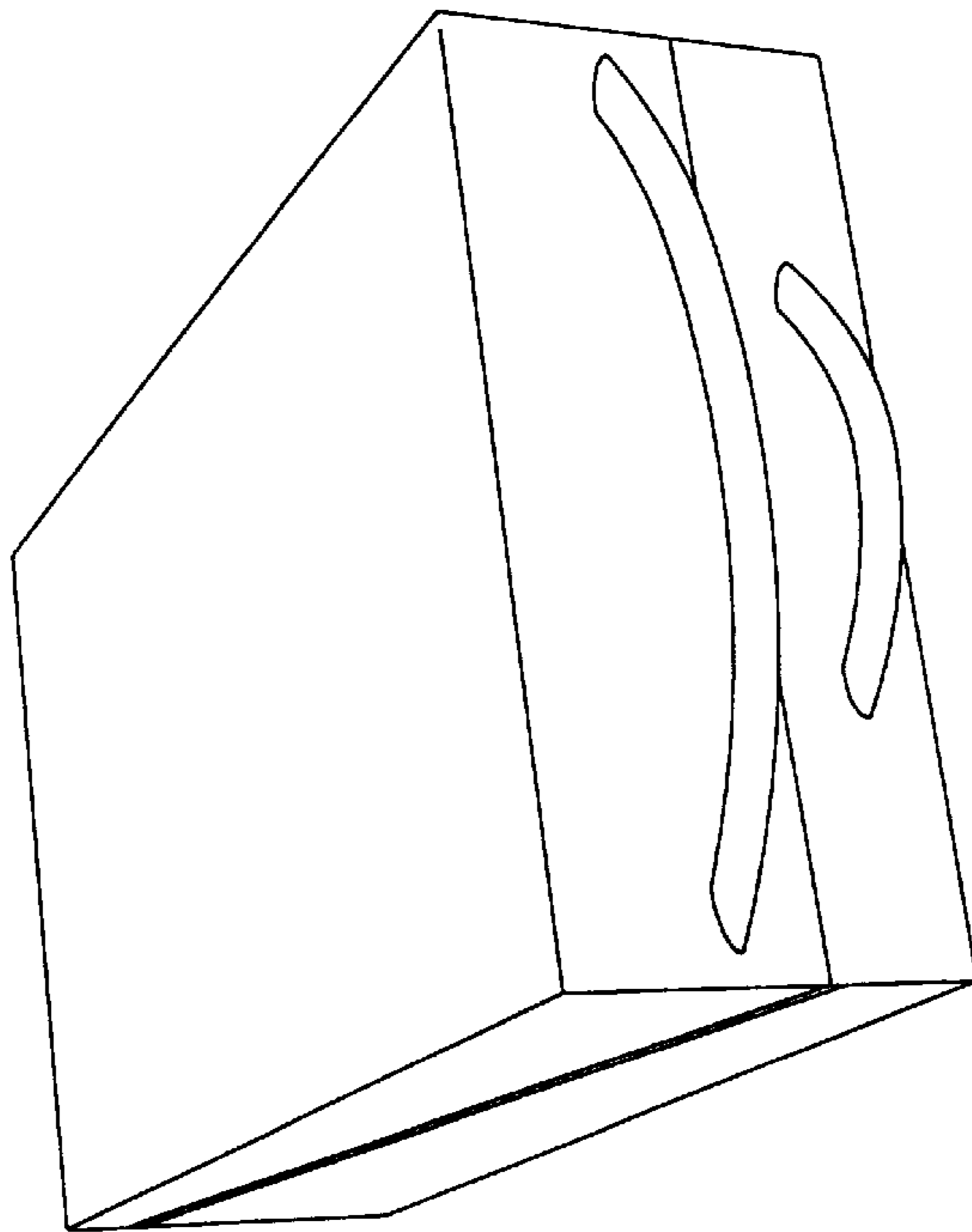

FIG. 7