



US00D429285S

United States Patent [19]
Schini

[11] **Patent Number: Des. 429,285**

[45] **Date of Patent: ** Aug. 8, 2000**

[54] **RED CARD SOUVENIR**

DESCRIPTION

[76] Inventor: **Michael D. Schini**, 131 Kirtland Dr.,
Naples, Fla. 34110

[**] Term: **14 Years**

[21] Appl. No.: **29/088,887**

[22] Filed: **Jun. 3, 1998**

[51] **LOC (7) Cl.** **20-03**

[52] **U.S. Cl.** **D20/32**

[58] **Field of Search** D20/29, 31, 32,
D20/33; D21/400; 40/586, 584

[56] **References Cited**

U.S. PATENT DOCUMENTS

D. 234,583	3/1975	Ehrlich	D20/33
D. 339,380	9/1993	Scapillato	D20/29
D. 339,609	9/1993	Martin et al.	D20/29
D. 397,740	9/1998	Georgevich	D21/100

Primary Examiner—Susan J. Lucas
Assistant Examiner—Jennifer Rivard

[57] **CLAIM**

I claim the ornamental design for a red card souvenir, as shown and described.

FIG. 1 is a perspective view taken from above showing applicant's red card souvenir.

FIG. 2 is a cross-sectional left side view of my red card souvenir taken along lines 2—2.

FIG. 3 is a cross-sectional rear elevational view of my red card souvenir taken along lines 3—3.

FIG. 4 is a perspective view showing in dotted lines a hand about to be placed in the slot of my red card souvenir.

FIG. 5 is a plan view taken from above of my red card souvenir.

FIG. 6 is a right side view of my red card souvenir.

FIG. 7 is a front elevational view of my red card souvenir.

FIG. 8 is a cutaway perspective view showing a human hand being placed in the slot of my red card souvenir; and,

FIG. 9 is a left side view of my red card souvenir.

The drawing is lined to indicate the color red.

A description of the appearance of the article is as follows:

The red card souvenir is made from a sheet of closed cell foamed plastic material printed in the form of a hand holding a red card which in the game of soccer signifies temporary ejection of a player from the game.

The surface(s) of the article not shown in the drawing or described in the specification form(s) no part of the claimed design.

The broken lines are shown for illustrative purposes only and form no part of the claimed design.

1 Claim, 4 Drawing Sheets

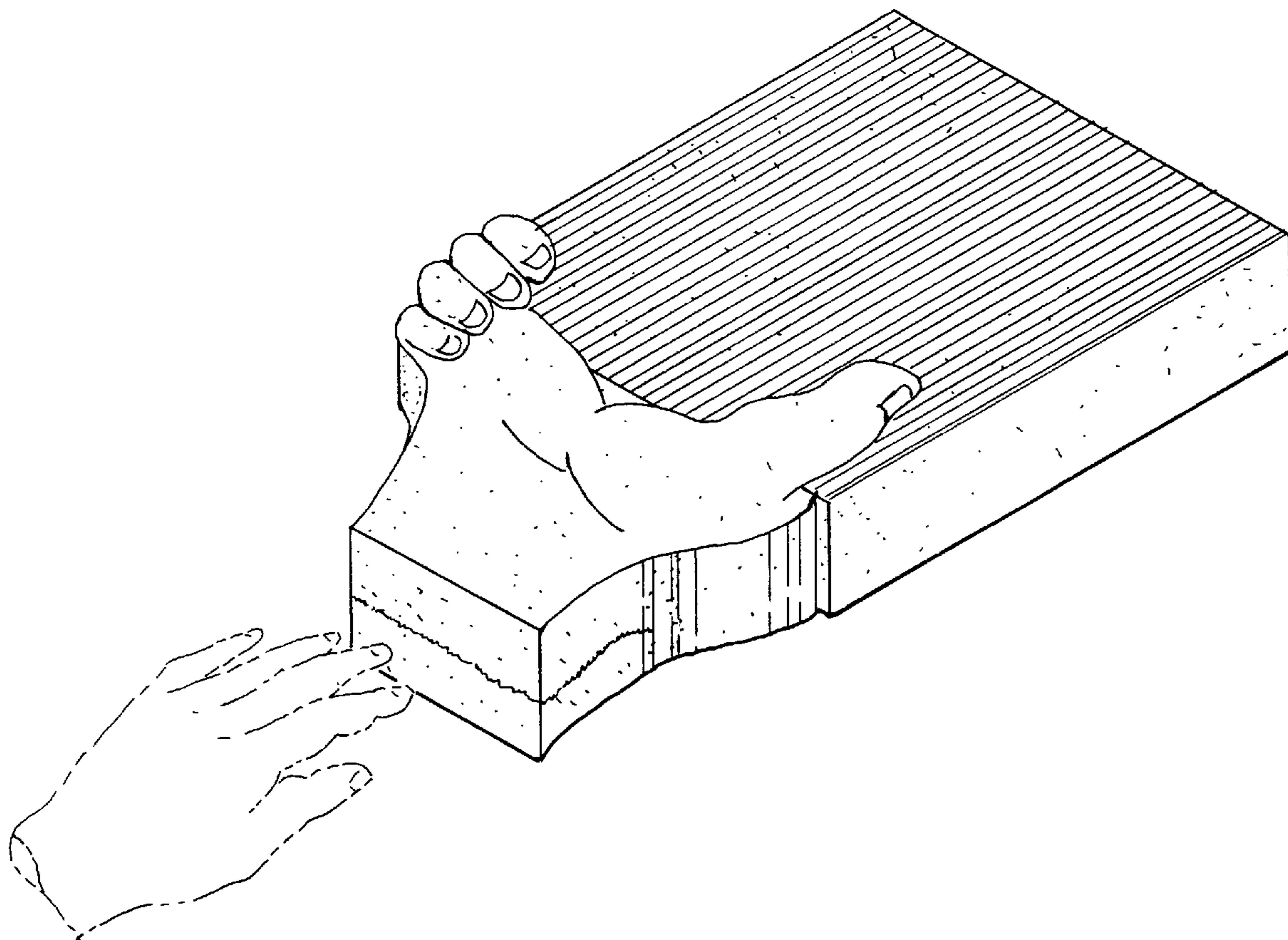

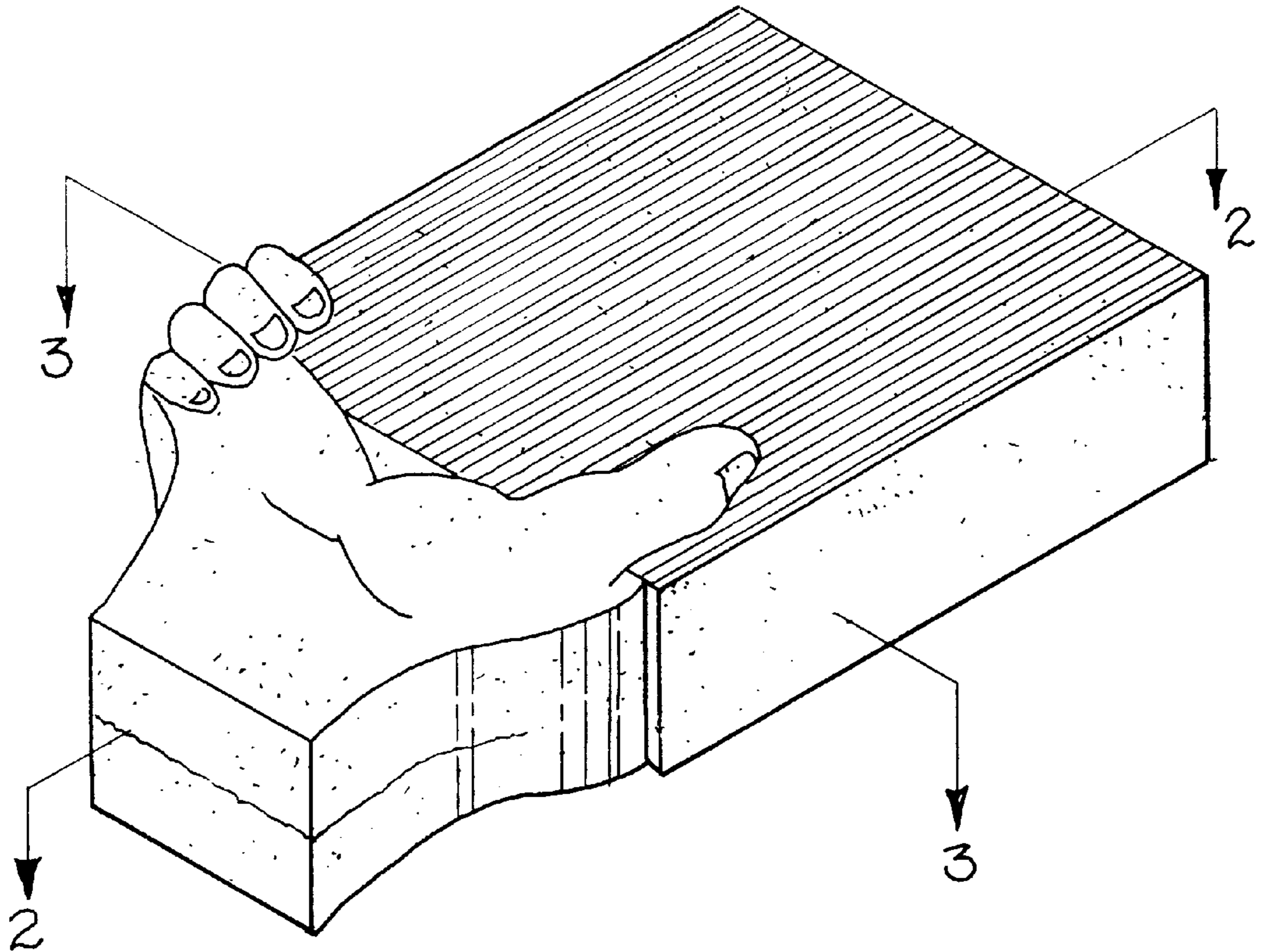

FIG. 1

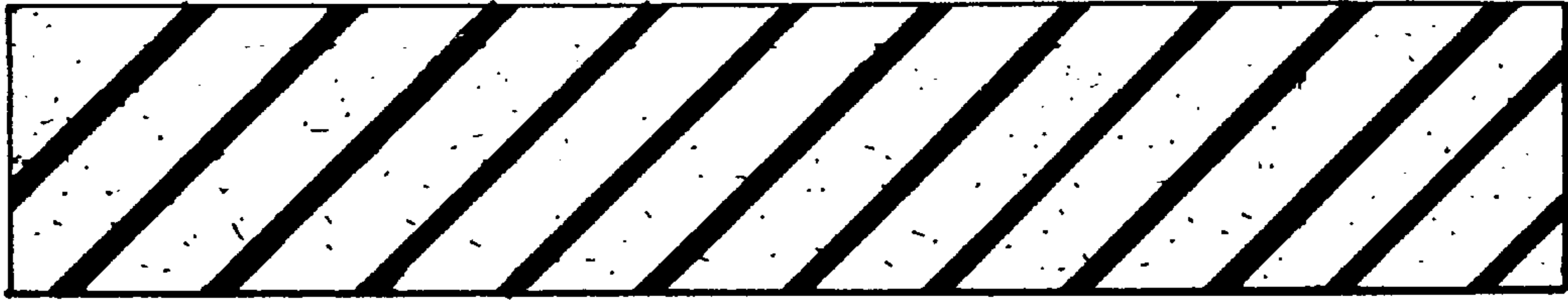

FIG. 2



FIG. 3

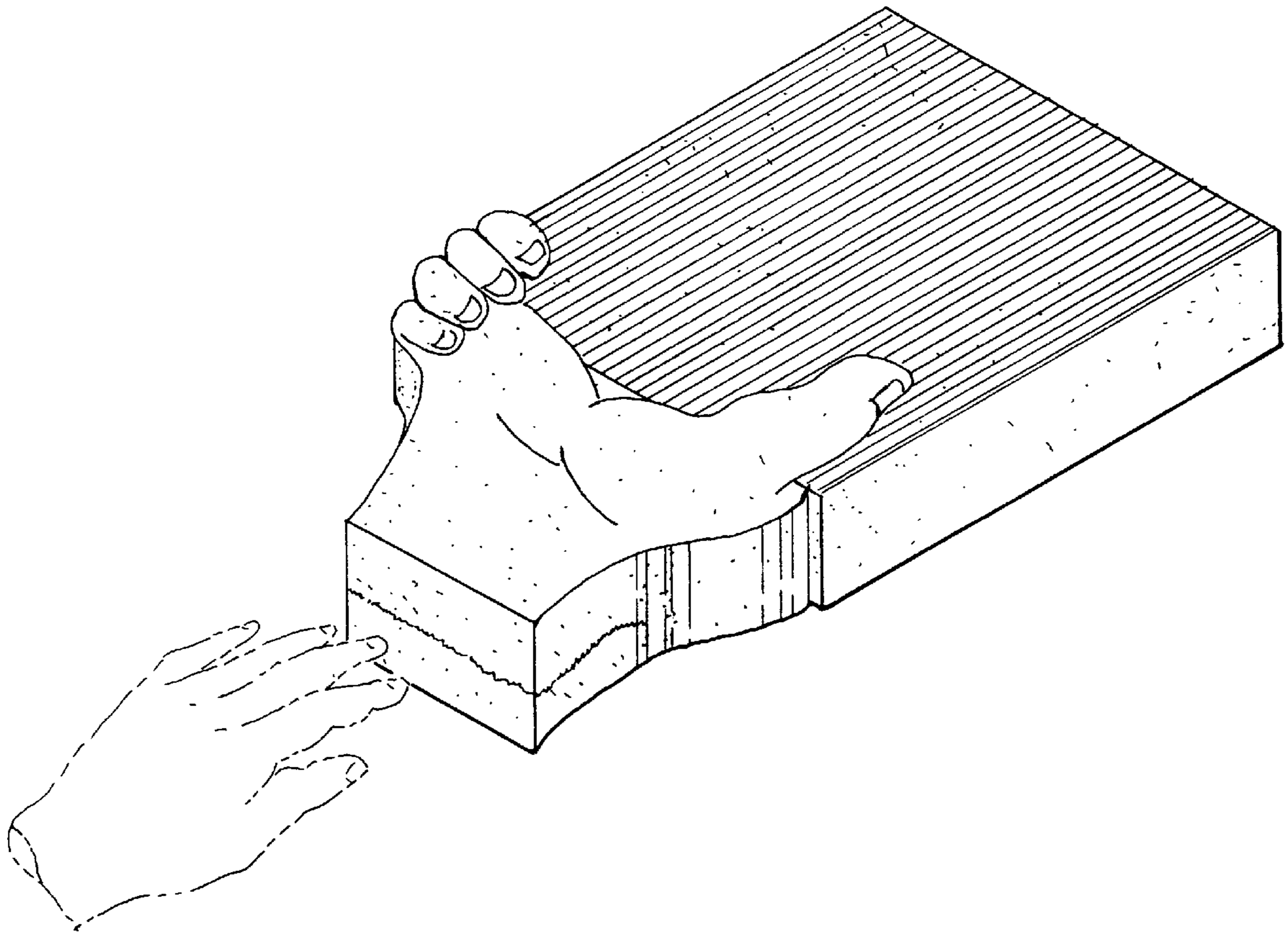

FIG. 4

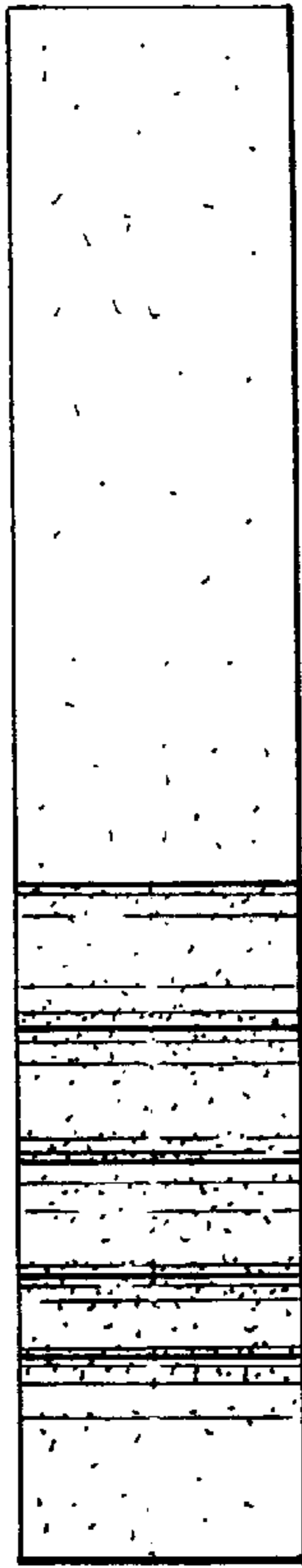

FIG. 9

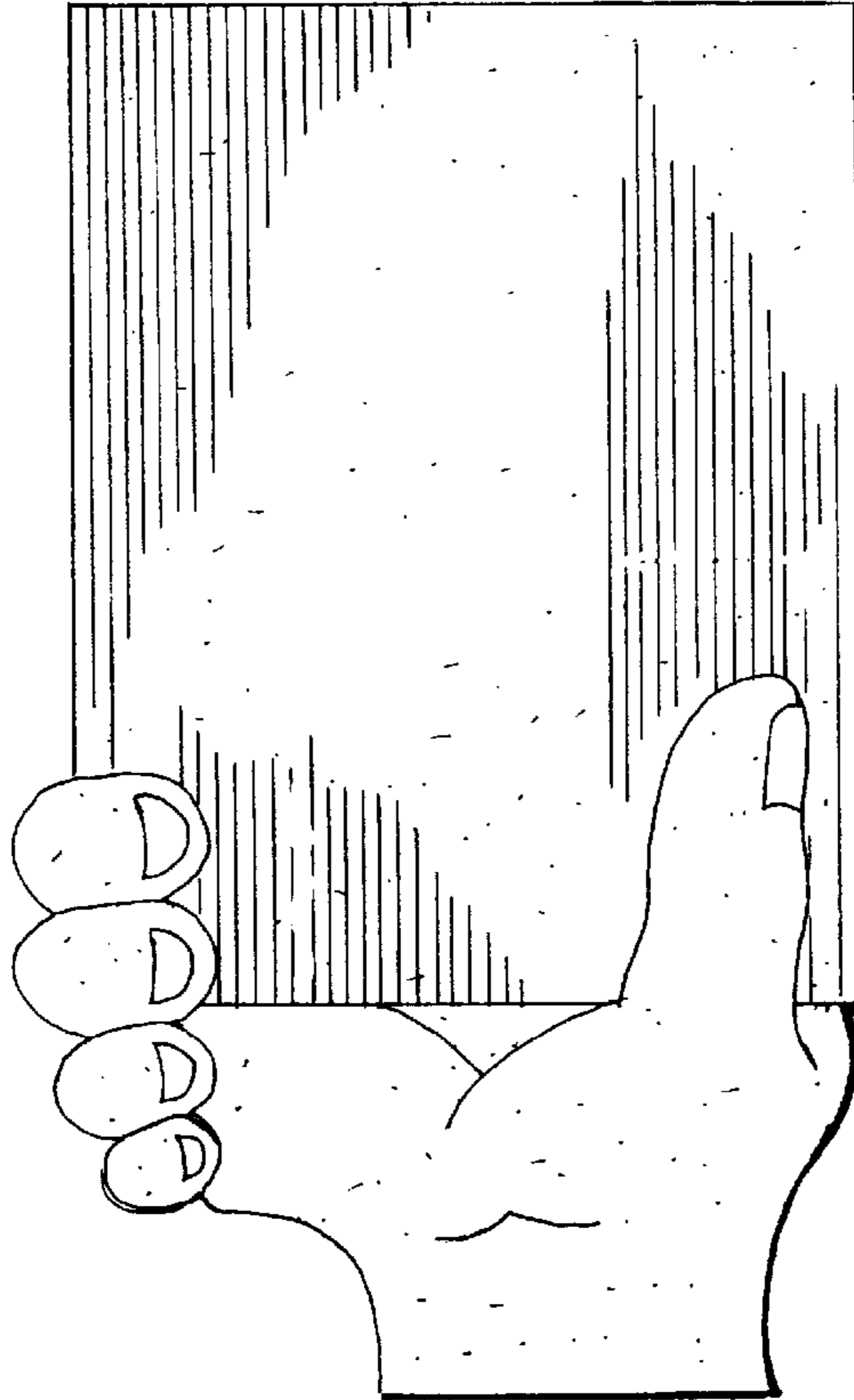

FIG. 5

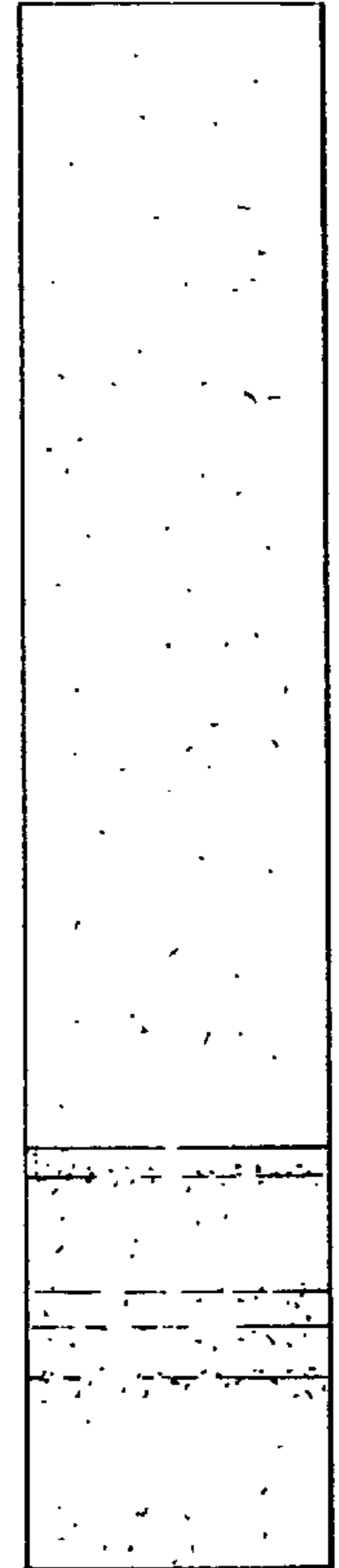

FIG. 6

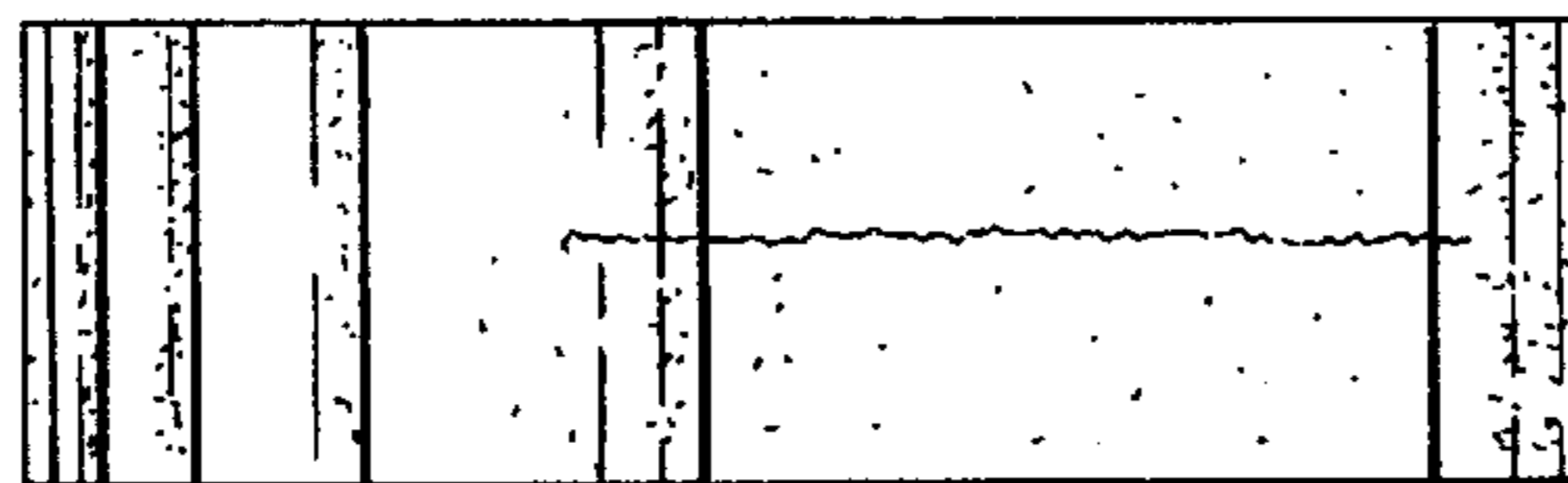

FIG. 7

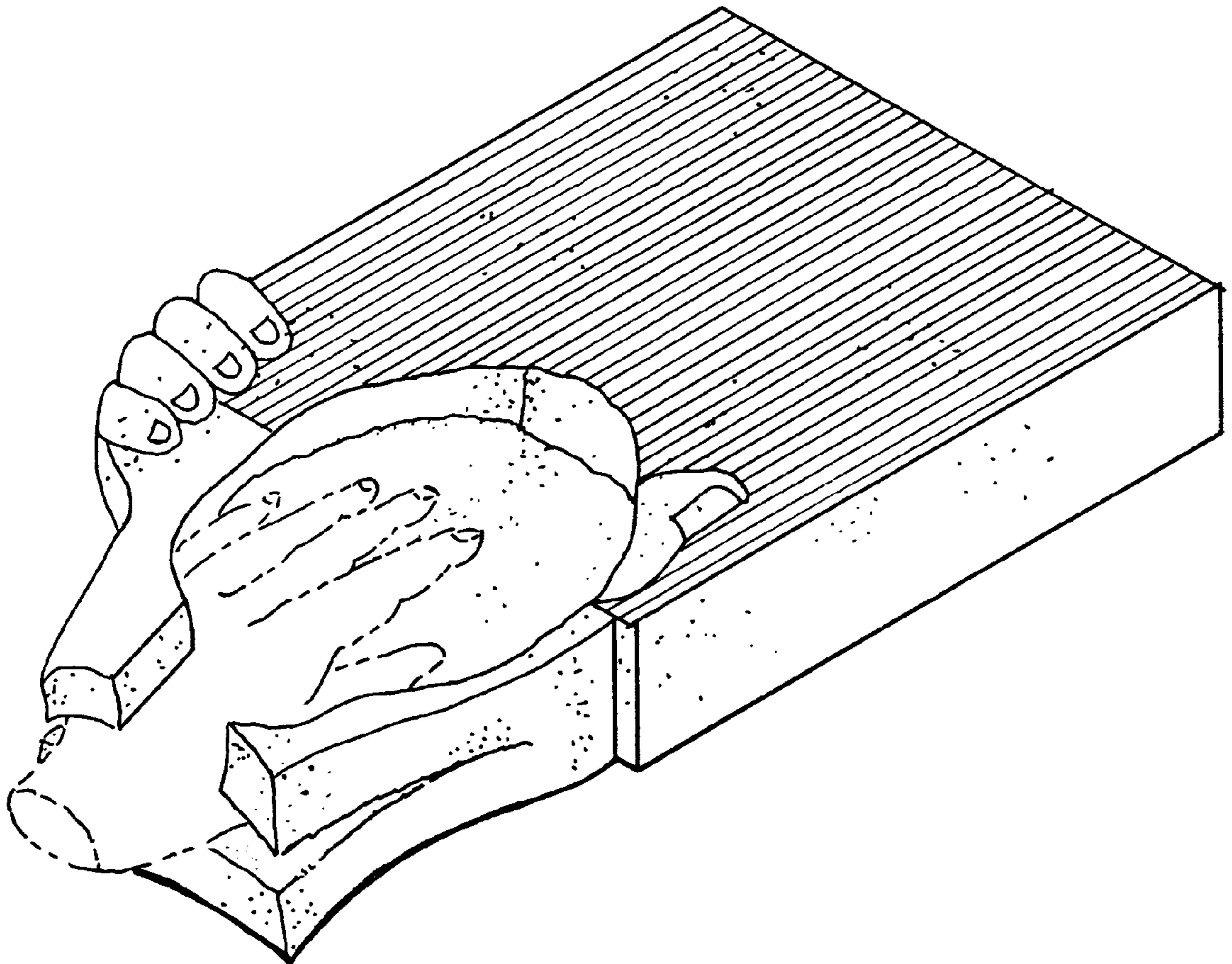

FIG. 8