



US00D429272S

**United States Patent** [19]  
**Chu**

[11] **Patent Number: Des. 429,272**

[45] **Date of Patent: \*\* Aug. 8, 2000**

[54] **COMBINATION CALCULATOR AND  
WORLD-TIME CALENDAR**

[75] Inventor: **William Chu**, Taipei, Taiwan

[73] Assignee: **Limax Electronics Co., Ltd.**, Taipei,  
Taiwan

[\*\*] Term: **14 Years**

[21] Appl. No.: **29/107,319**

[22] Filed: **Jul. 1, 1999**

[51] **LOC (7) Cl.** ..... **18-01**

[52] **U.S. Cl.** ..... **D18/2; D18/7**

[58] **Field of Search** ..... D18/2, 6, 7; 235/61 R,  
235/59 R, 59 BG; 364/706-710

[56] **References Cited**

**U.S. PATENT DOCUMENTS**

- D. 268,186 3/1983 Mandel et al. .... D18/7
- D. 398,627 9/1998 Leung ..... D18/7

*Primary Examiner*—Caron D. Veynar

*Attorney, Agent, or Firm*—Salter & Michaelson

[57] **CLAIM**

The ornamental design for a combination calculator and world-time calendar, as shown and described.

**DESCRIPTION**

FIG. 1 is a perspective view of a combination calculator and world-time calendar showing my new design, with the cover in open, operative position;

FIG. 2 is a front elevational view thereof;

FIG. 3 is a rear elevational view thereof;

FIG. 4 is a top plan view thereof;

FIG. 5 is a bottom plan view thereof;

FIG. 6 is a left side view thereof;

FIG. 7 is a right side view thereof;

FIG. 8 is a perspective view thereof with the cover in closed position;

FIG. 9 is a perspective view showing a modified form of my design, with the cover in open, operative position;

FIG. 10 is a front elevational view thereof;

FIG. 11 is a rear elevational view thereof;

FIG. 12 is a top plan view thereof;

FIG. 13 is a bottom plan view thereof;

FIG. 14 is a left side view thereof;

FIG. 15 is a right side view thereof; and,

FIG. 16 is a perspective view thereof with the cover in closed position.

**1 Claim, 10 Drawing Sheets**

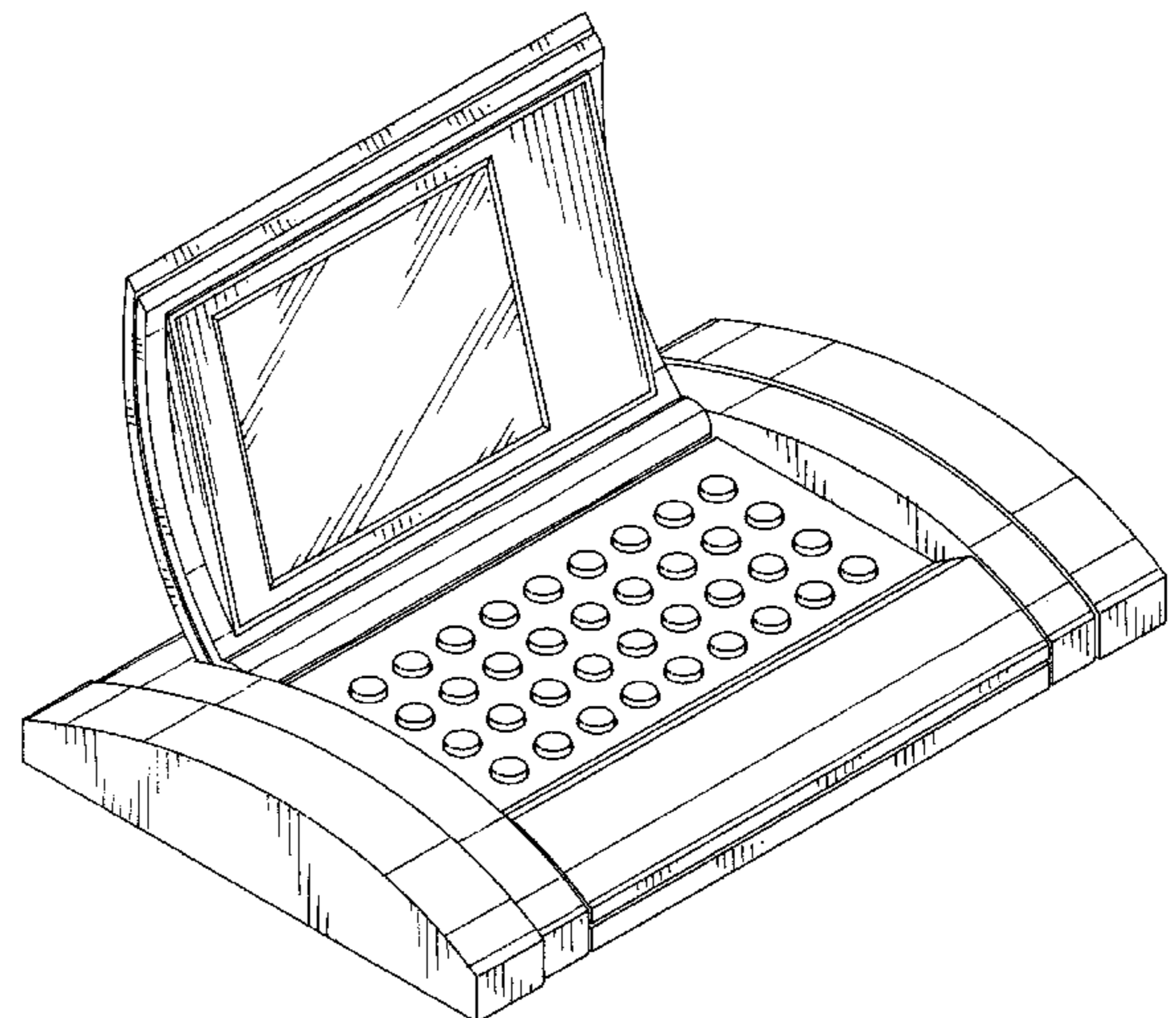
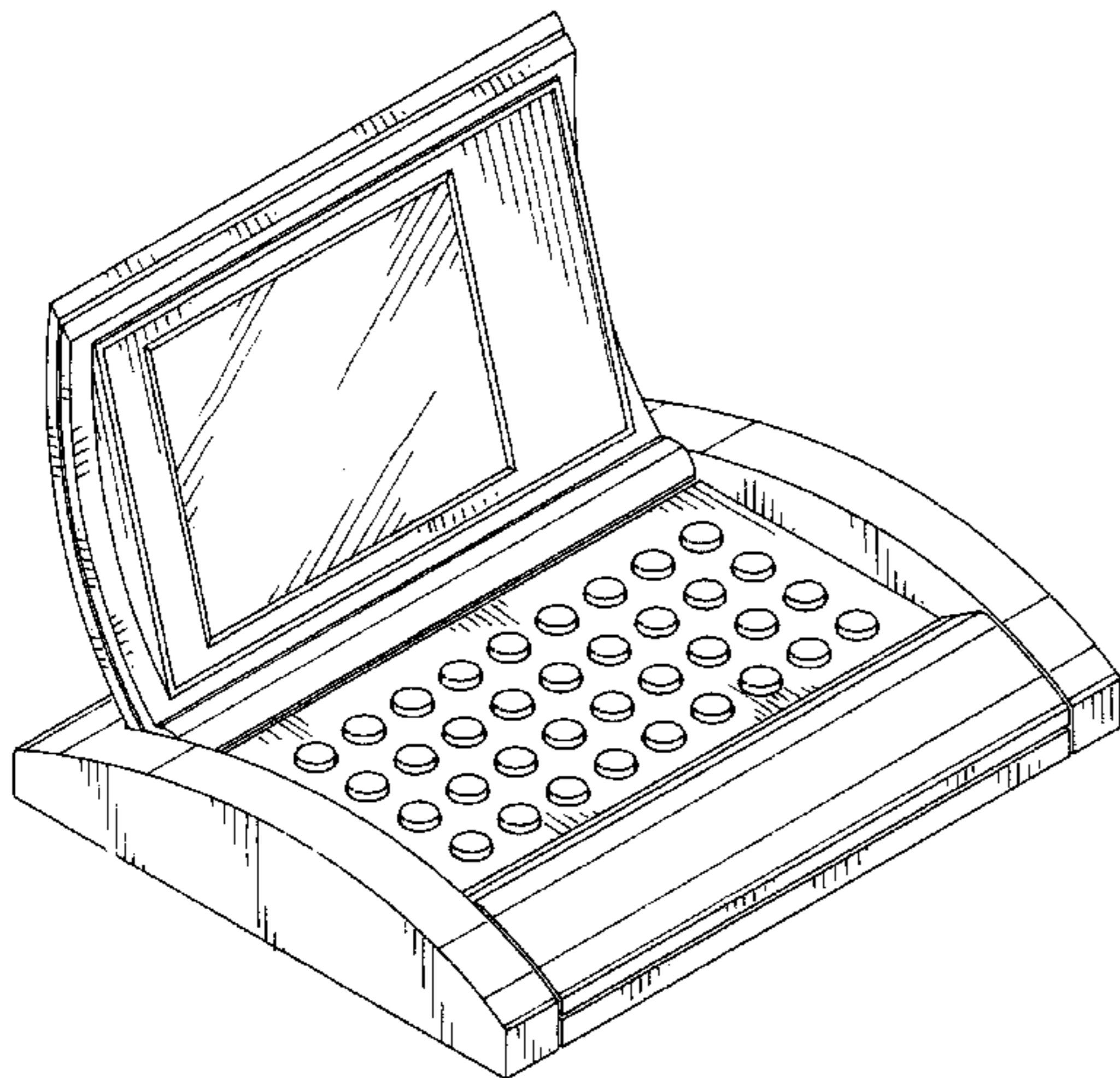

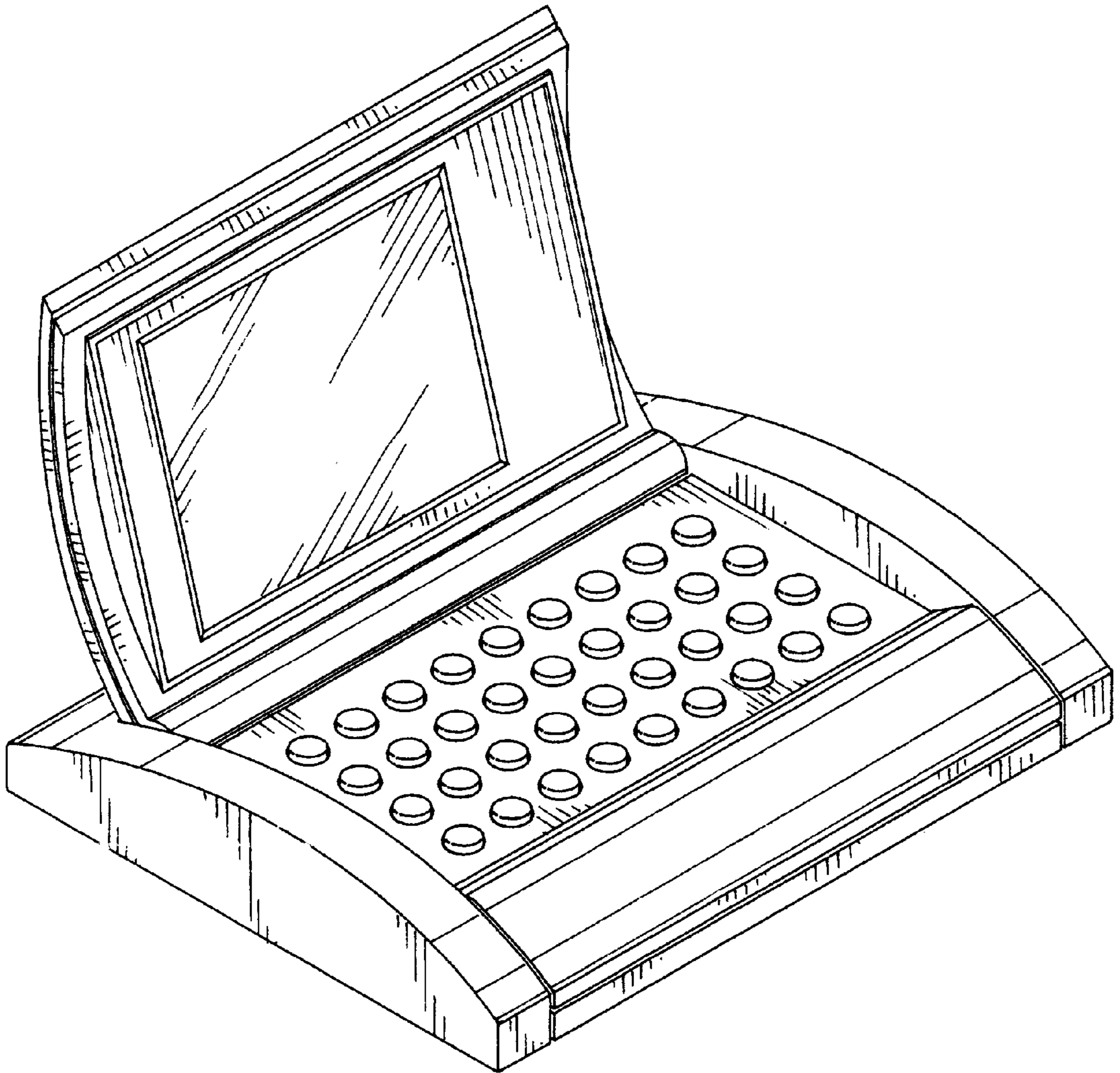

FIG. 1

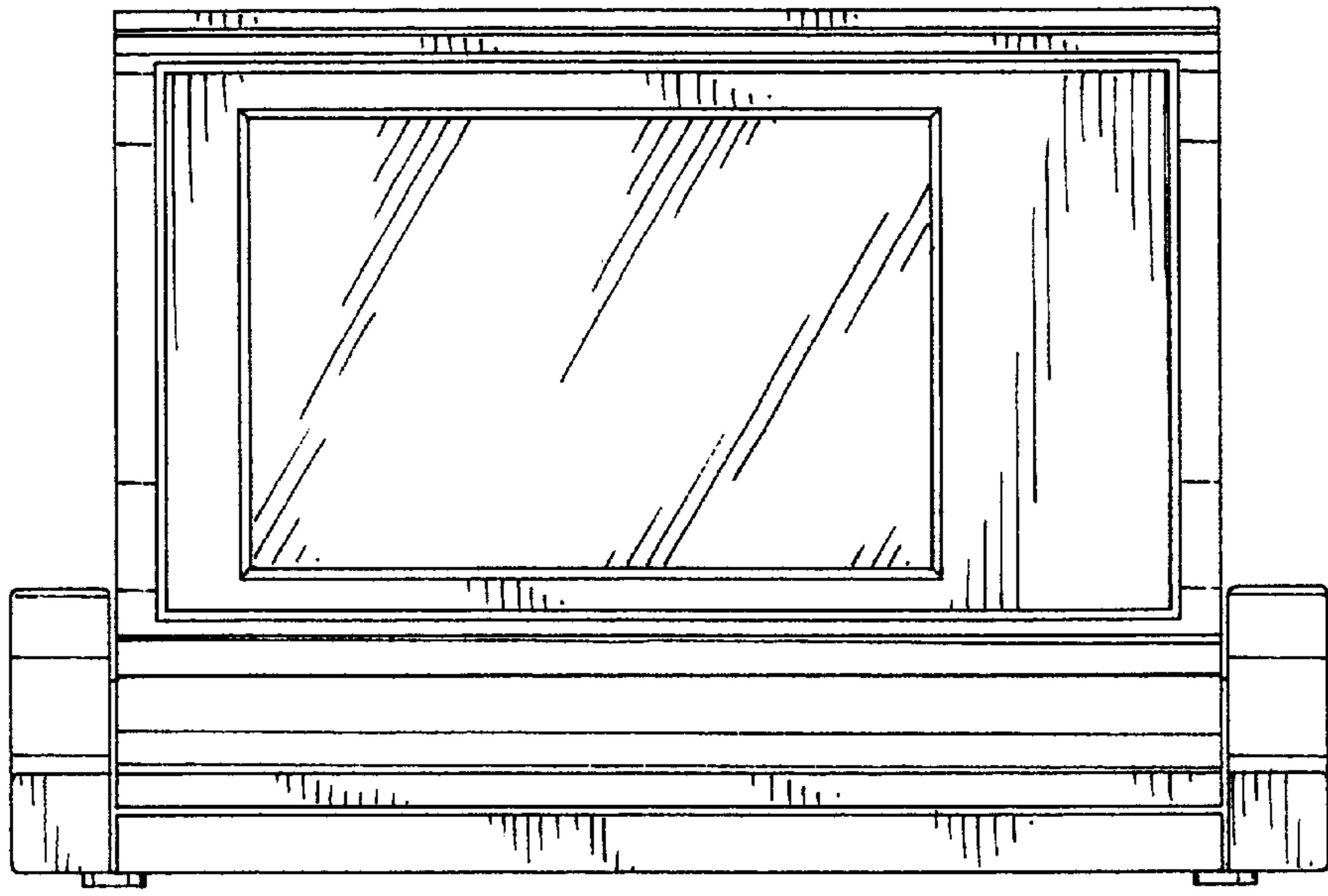

FIG. 2

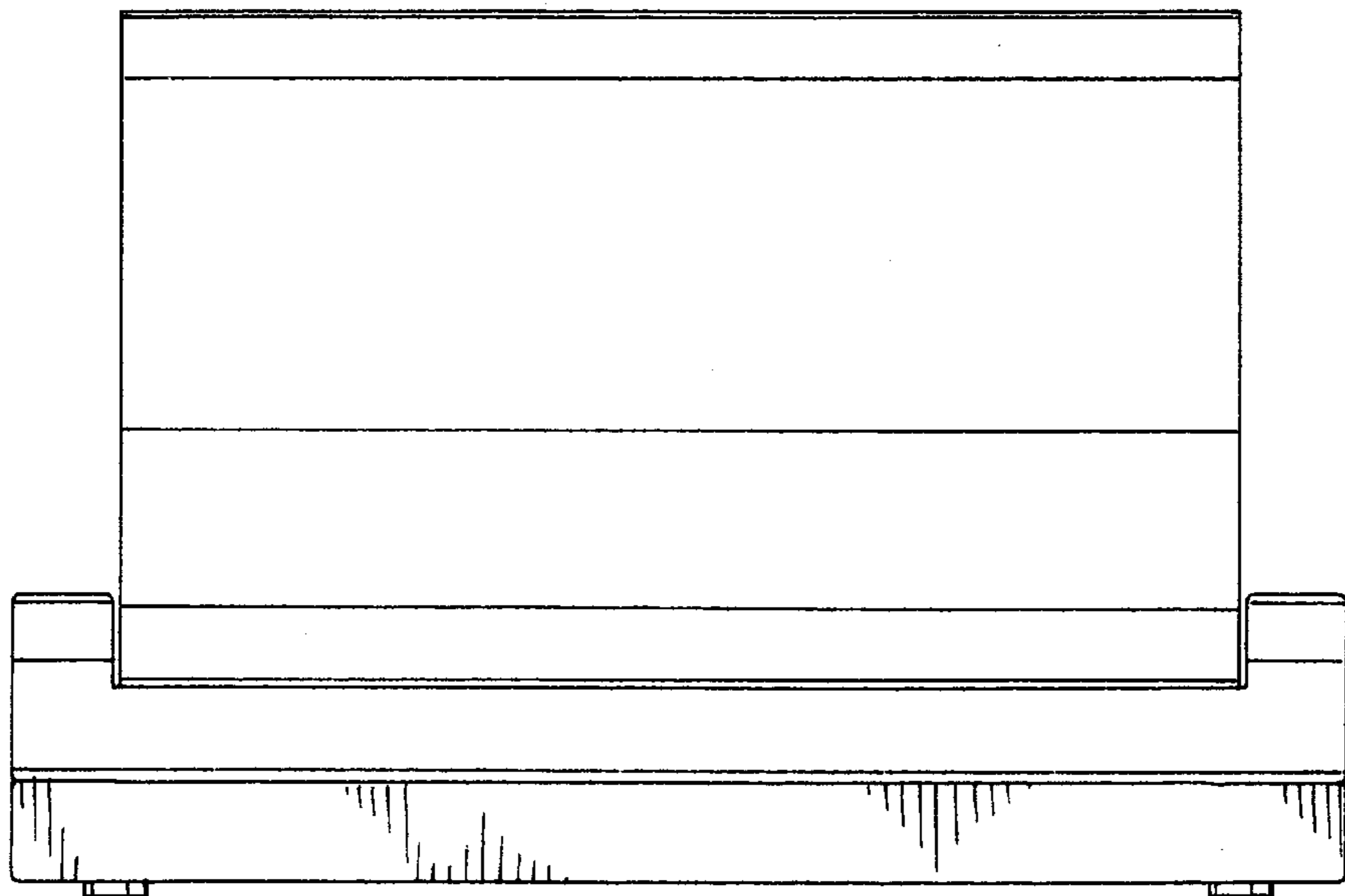

FIG. 3

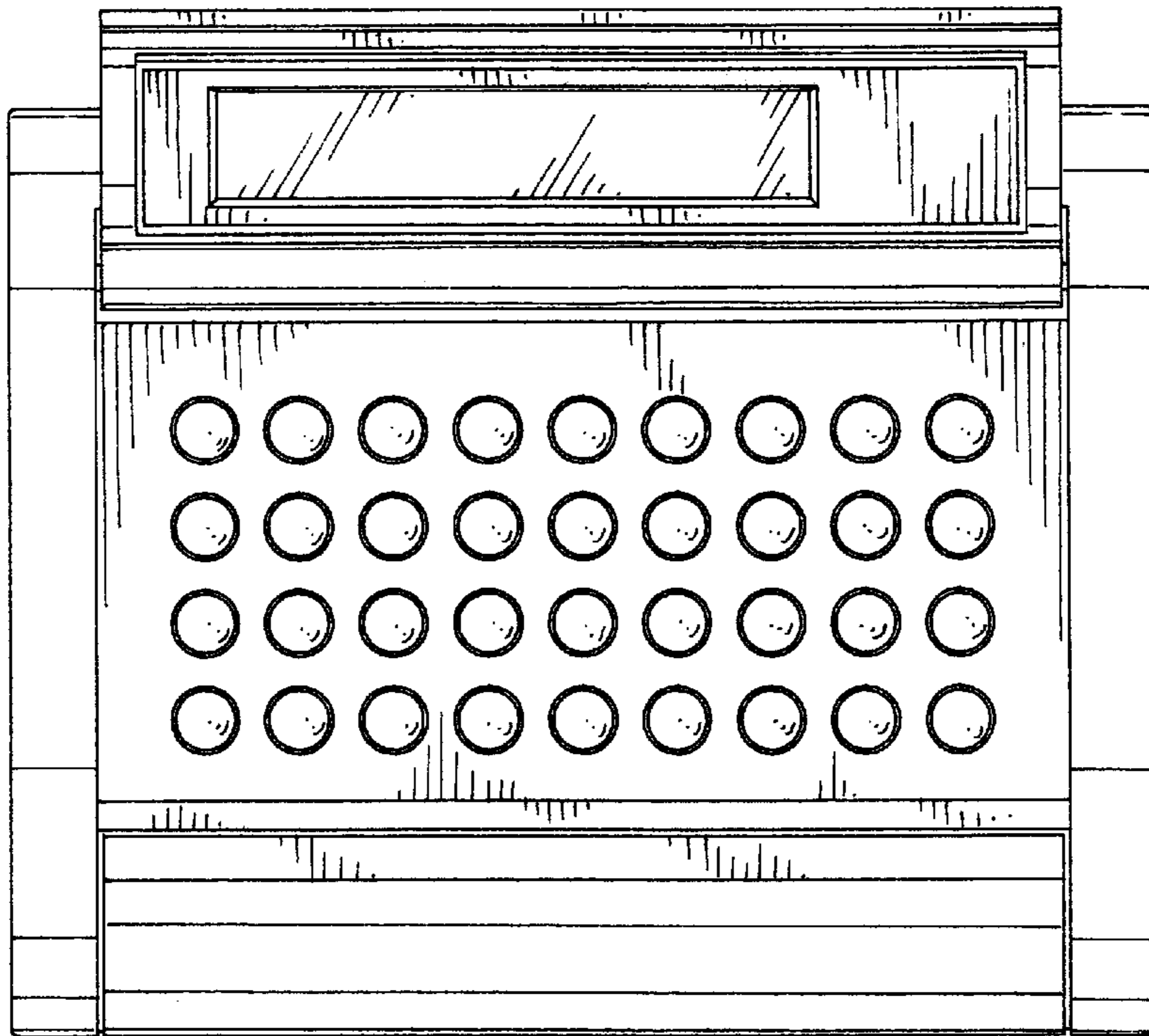

FIG. 4

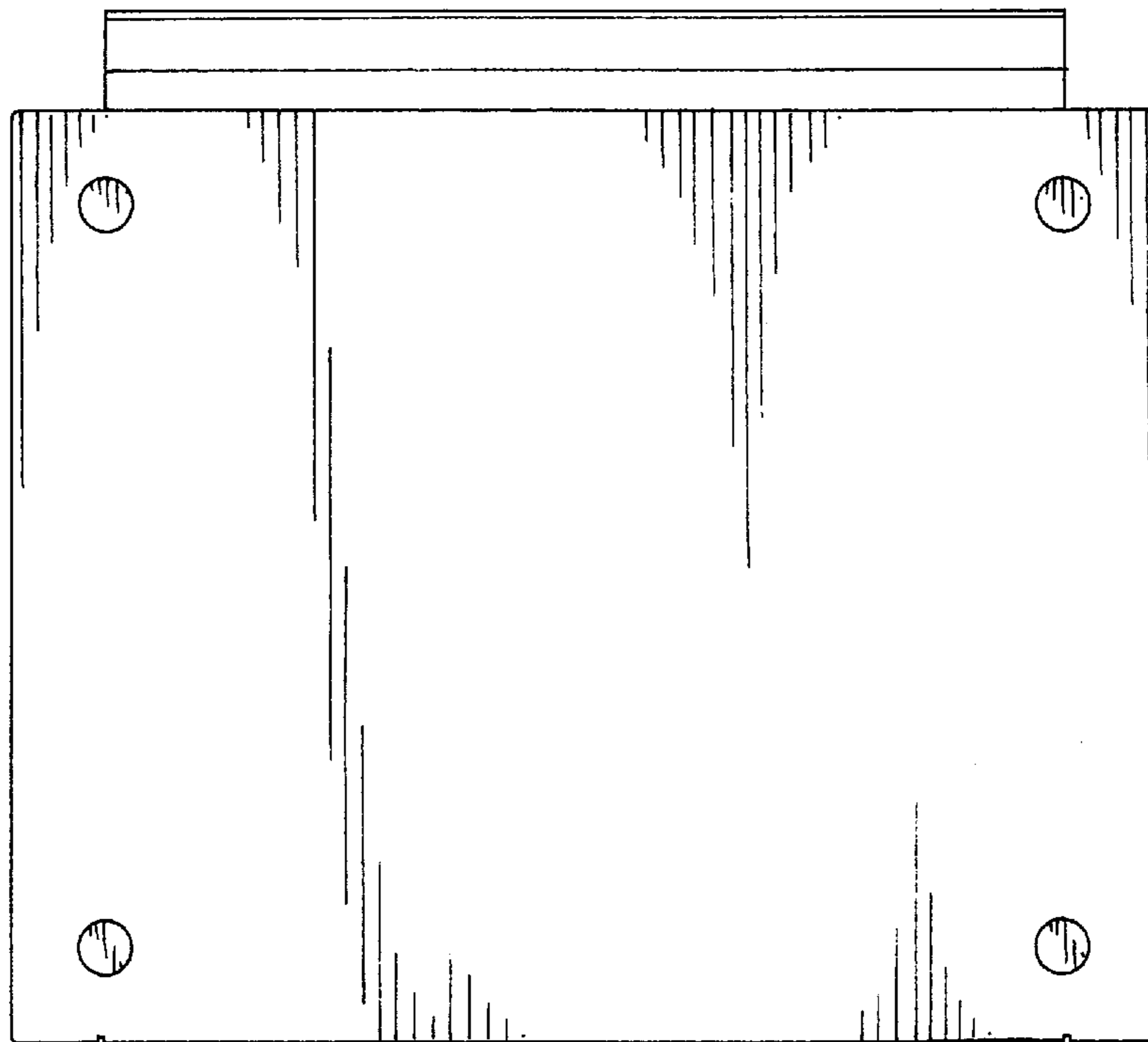

FIG. 5

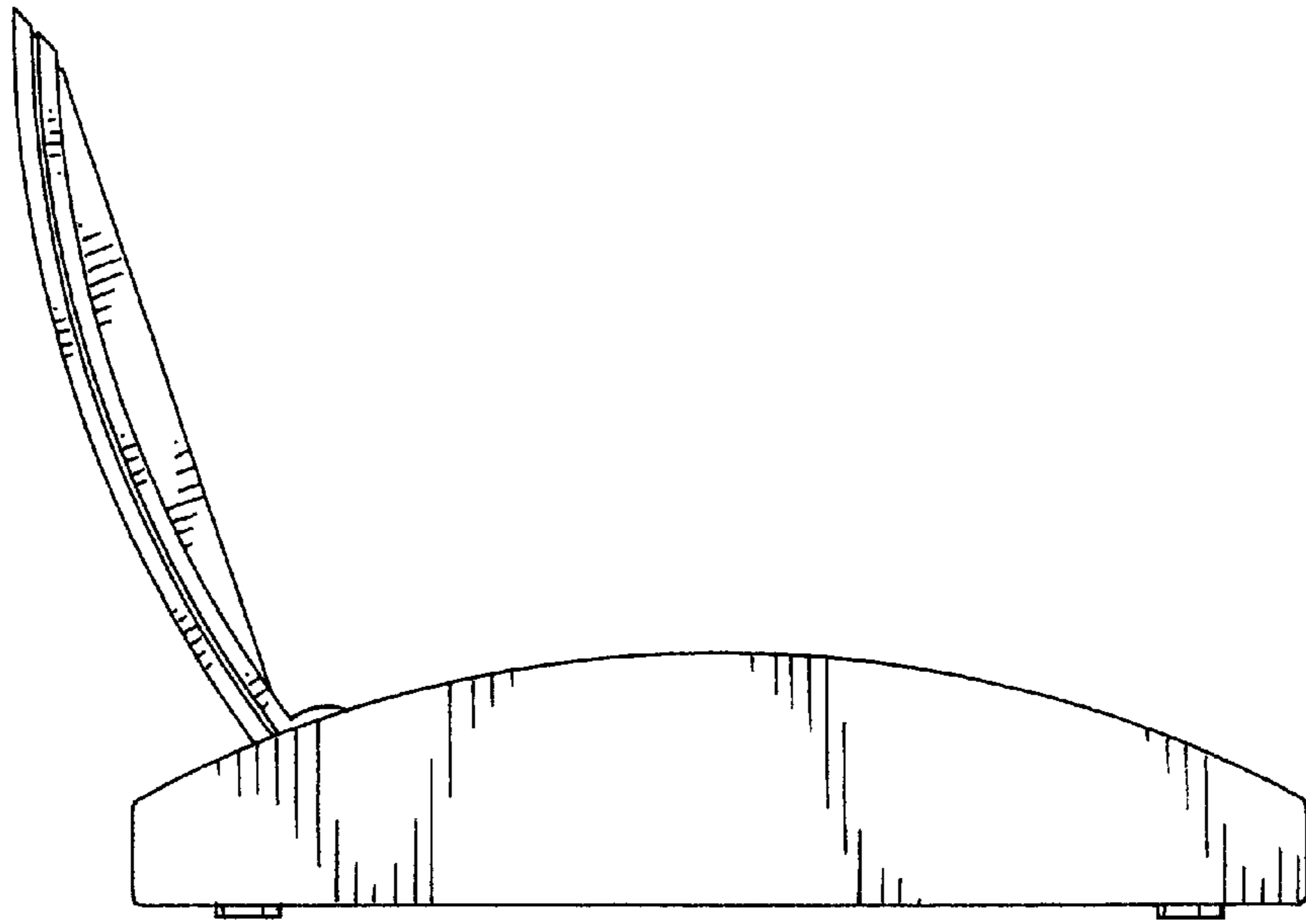

FIG. 6

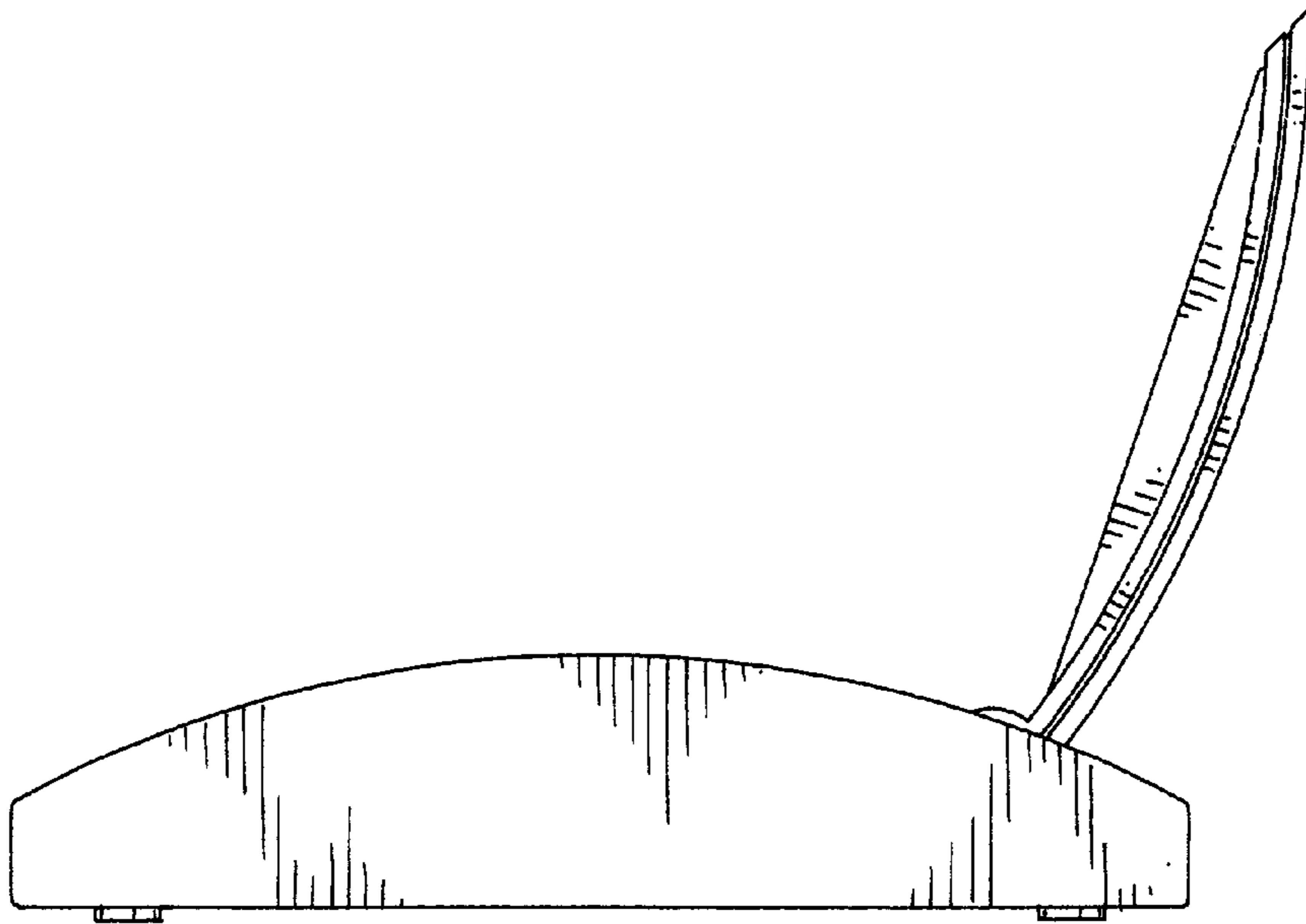

FIG. 7

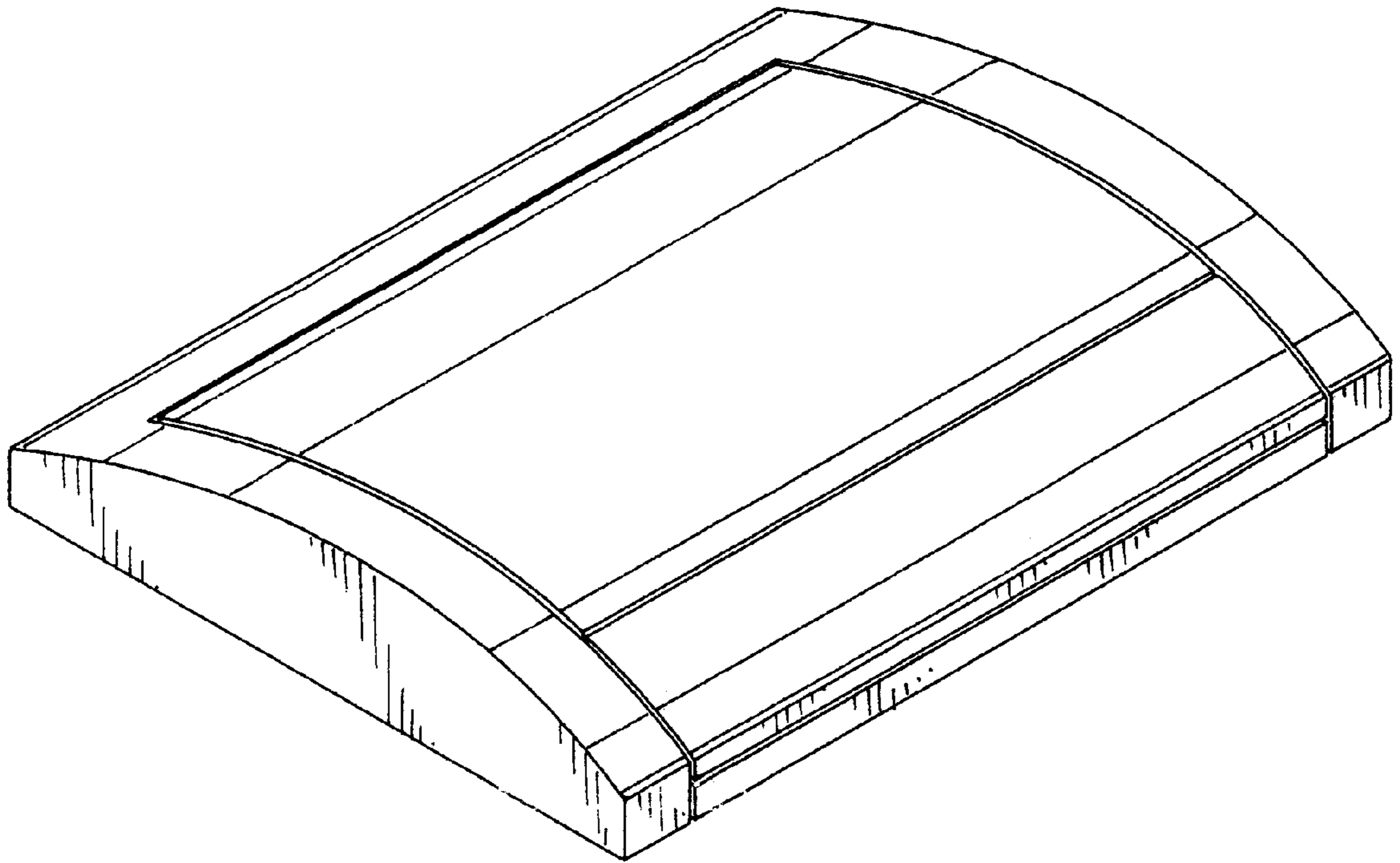

FIG. 8

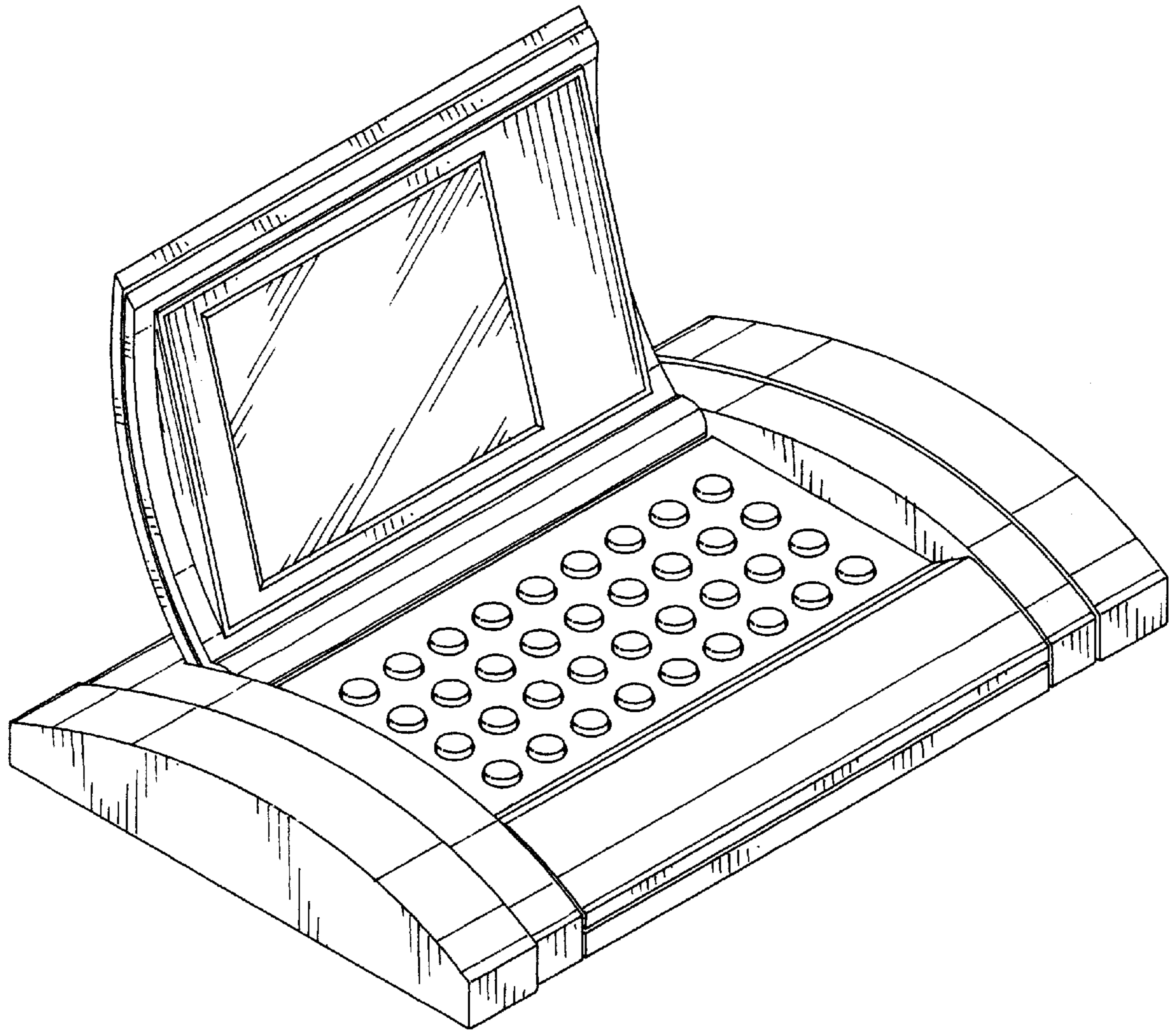

FIG. 9

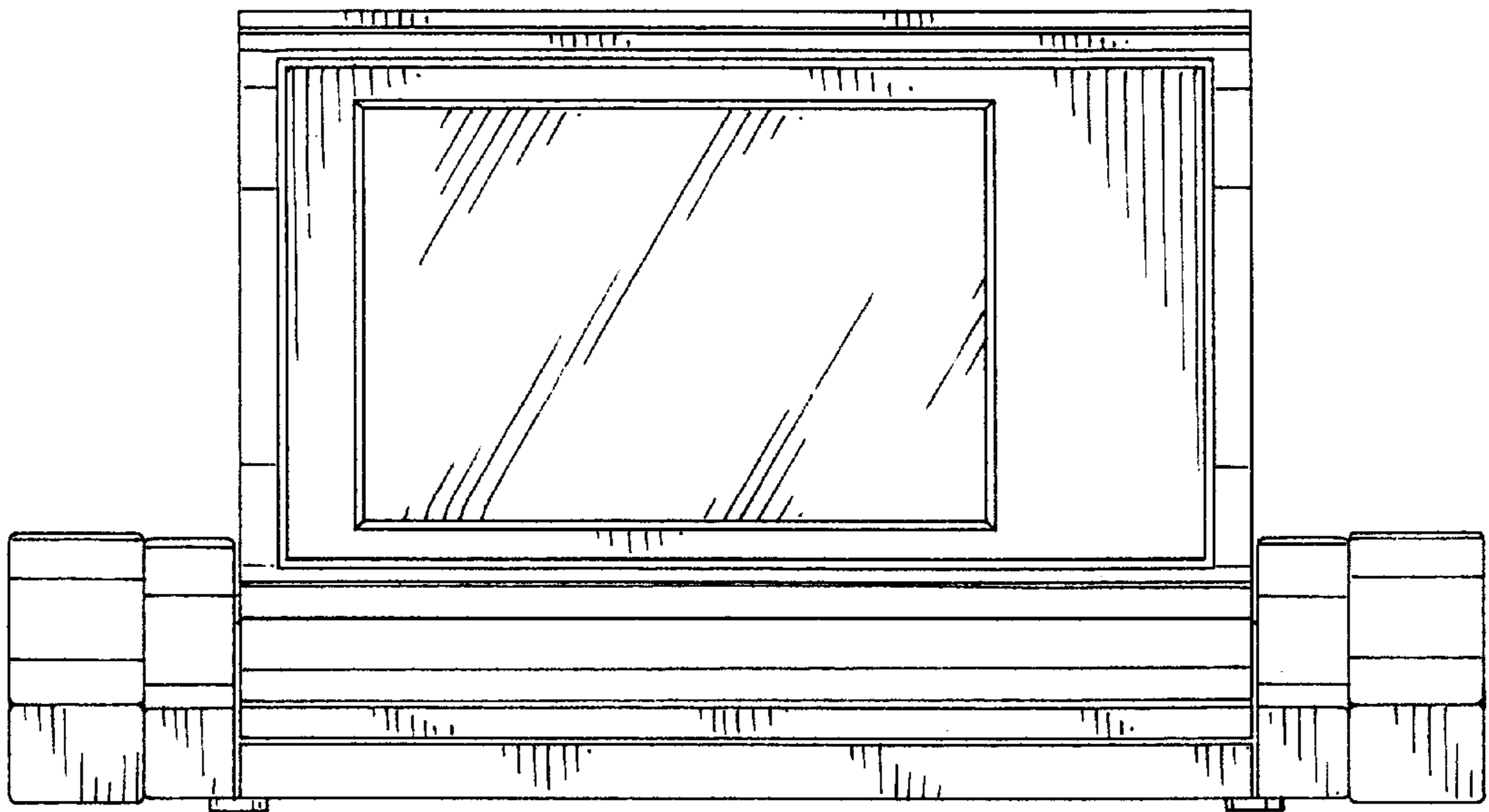

FIG. 10

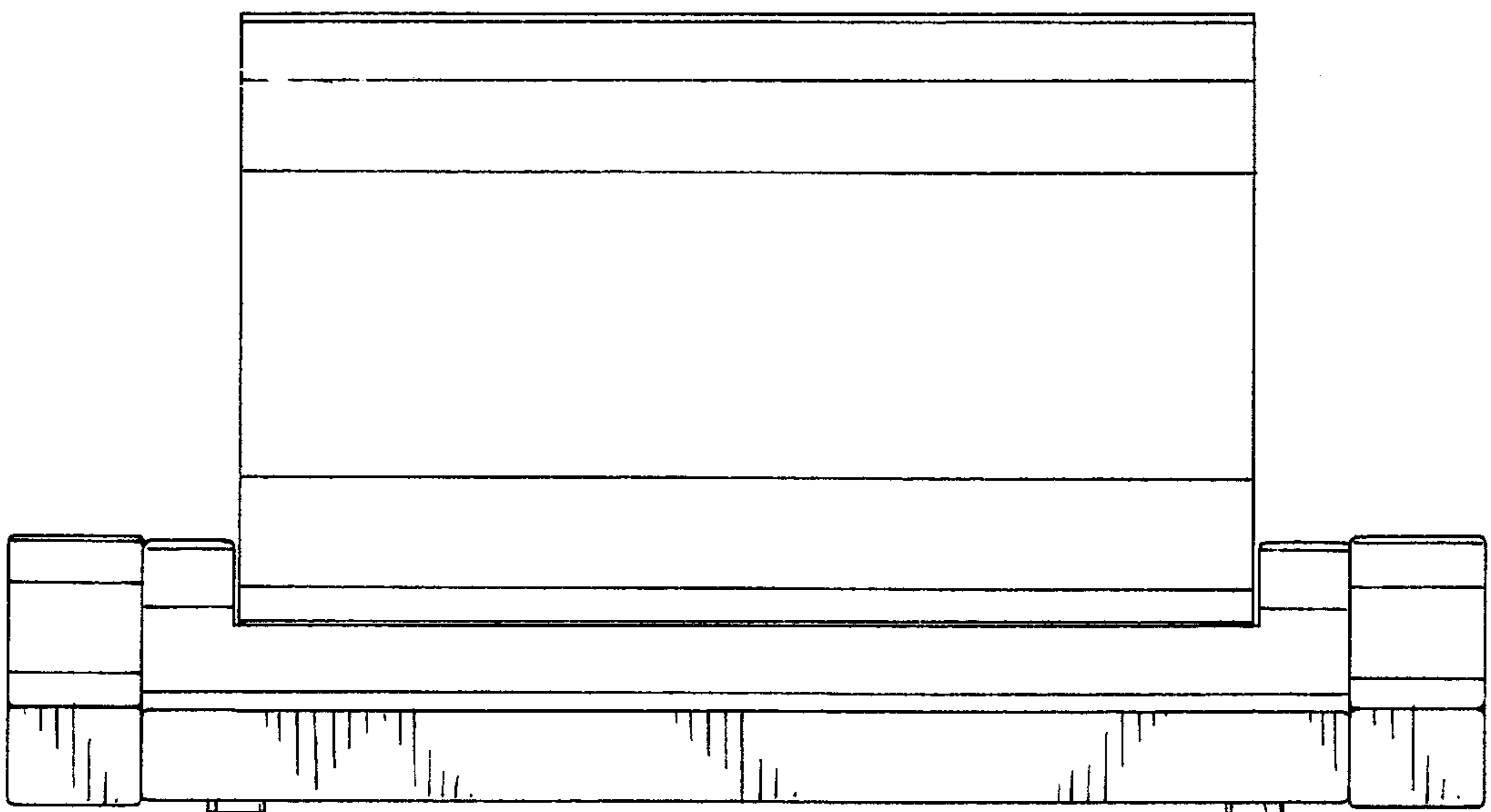

FIG. 11



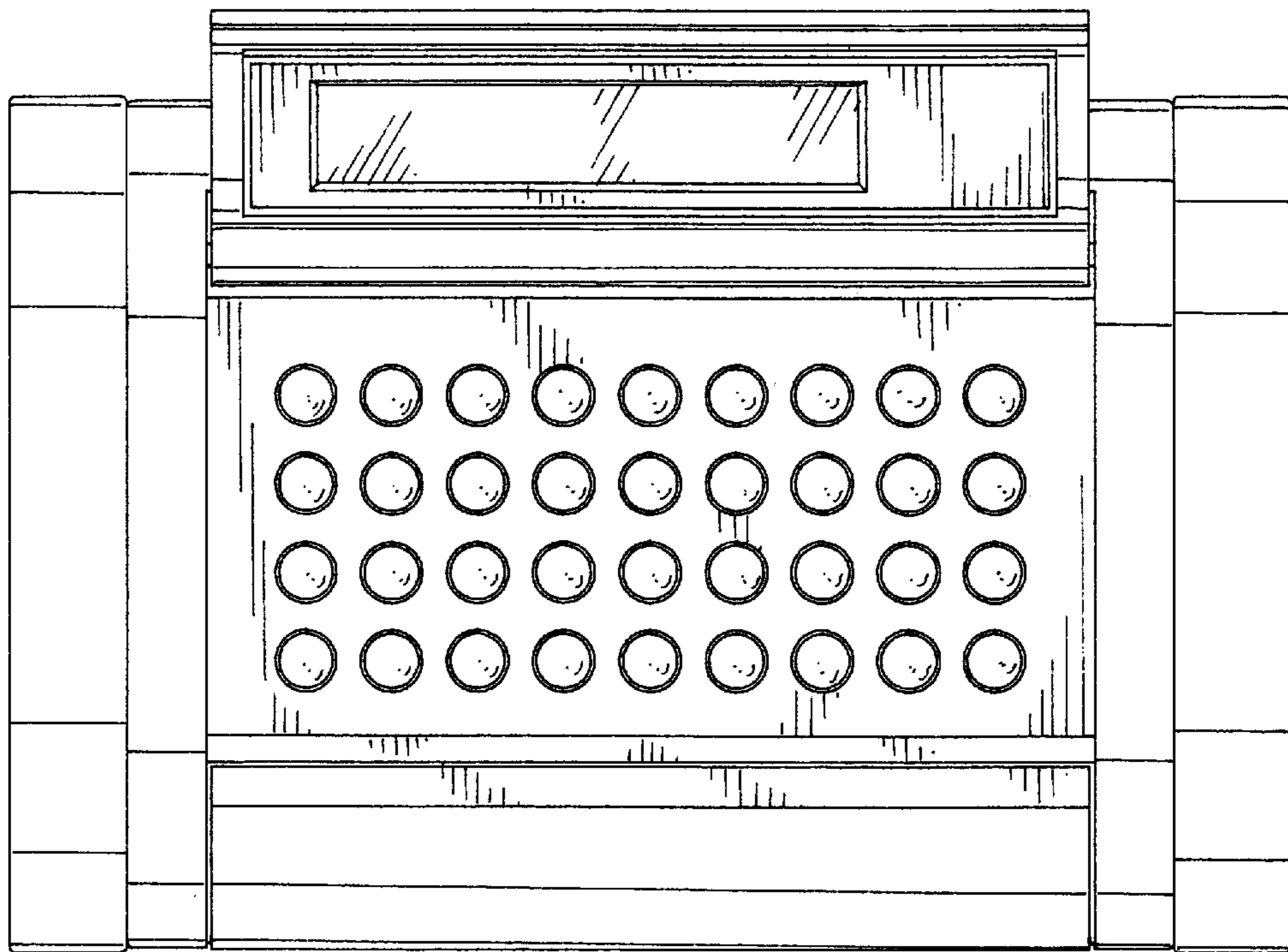

FIG. 12

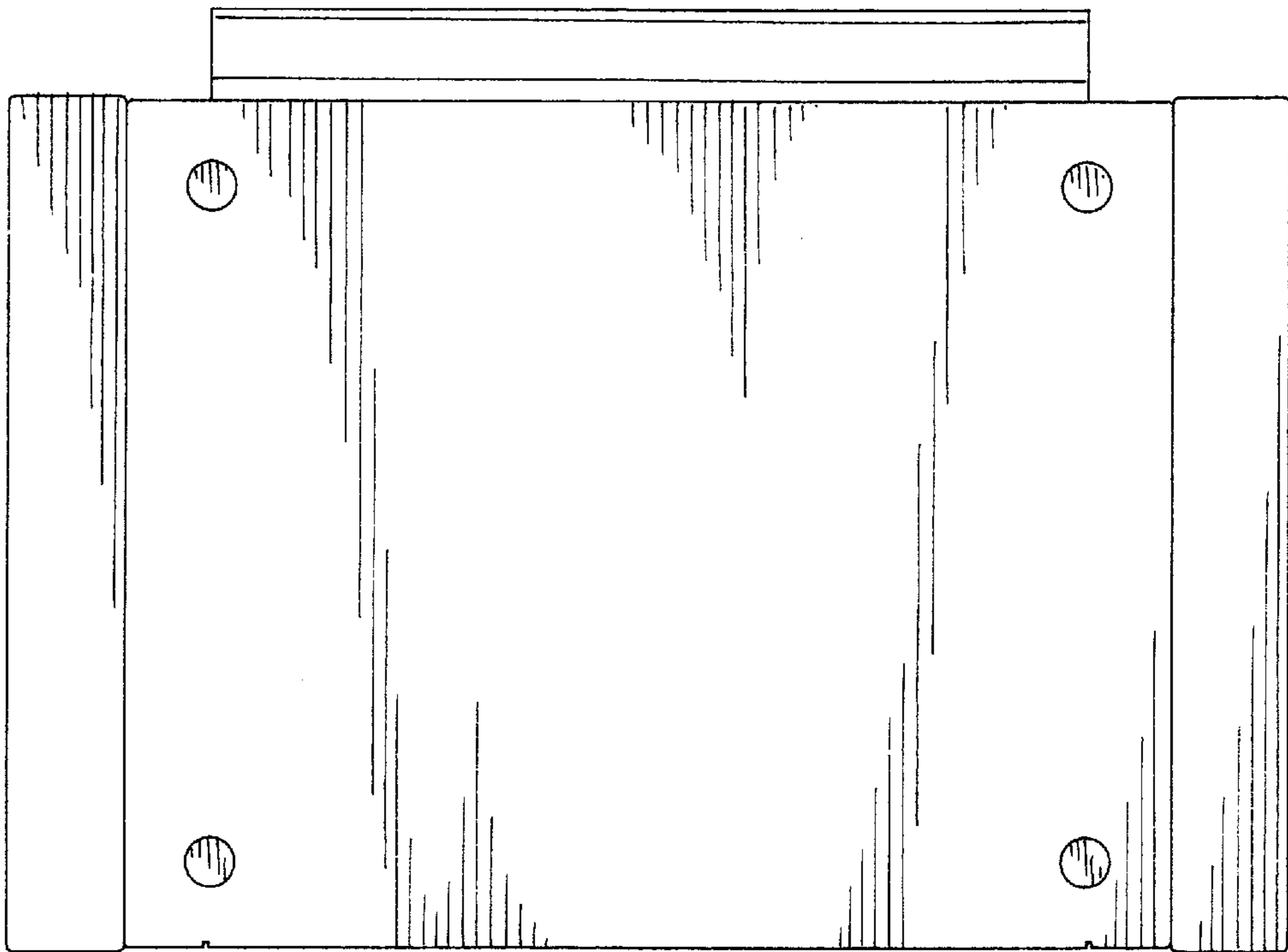

FIG. 13

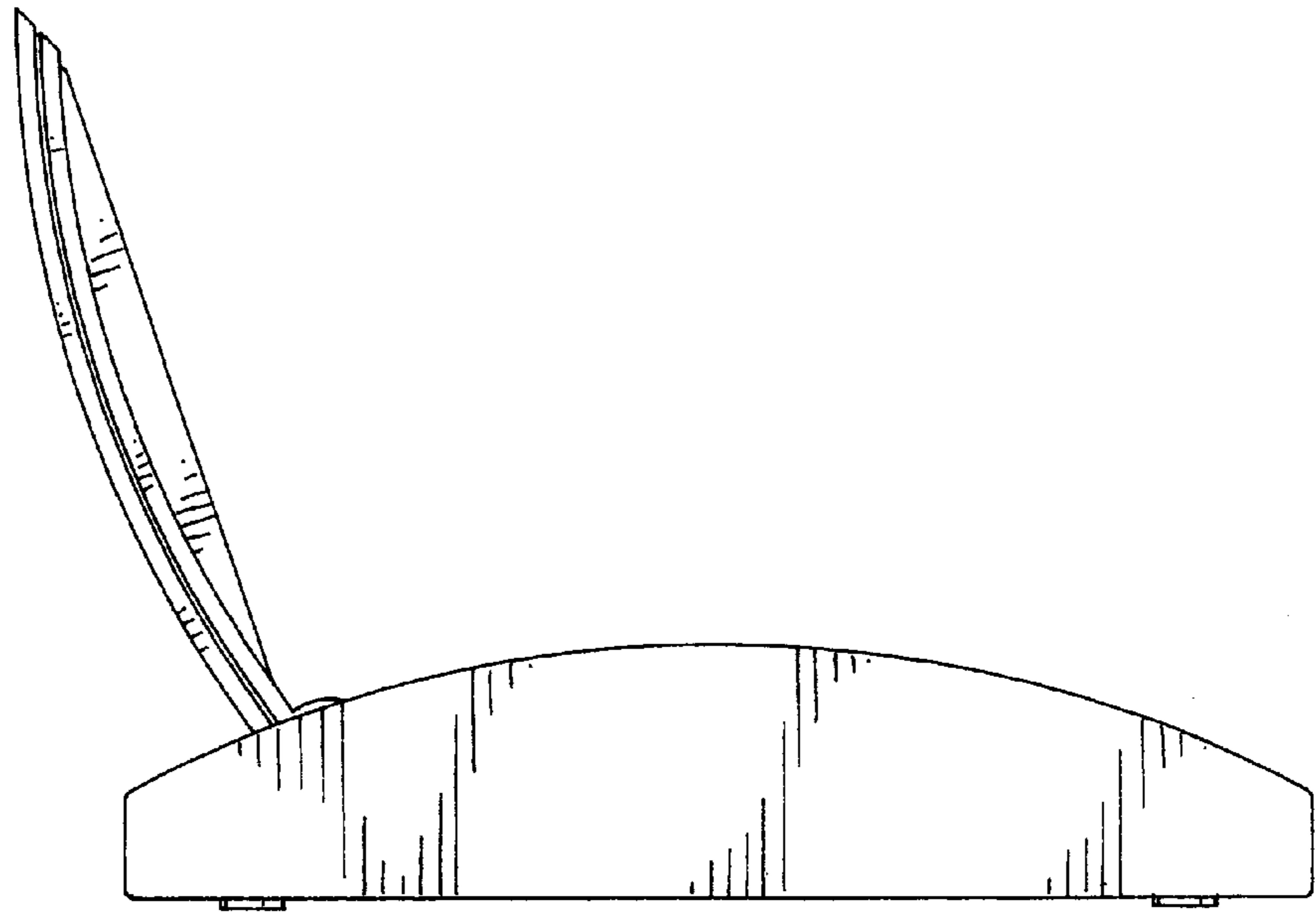

FIG. 14

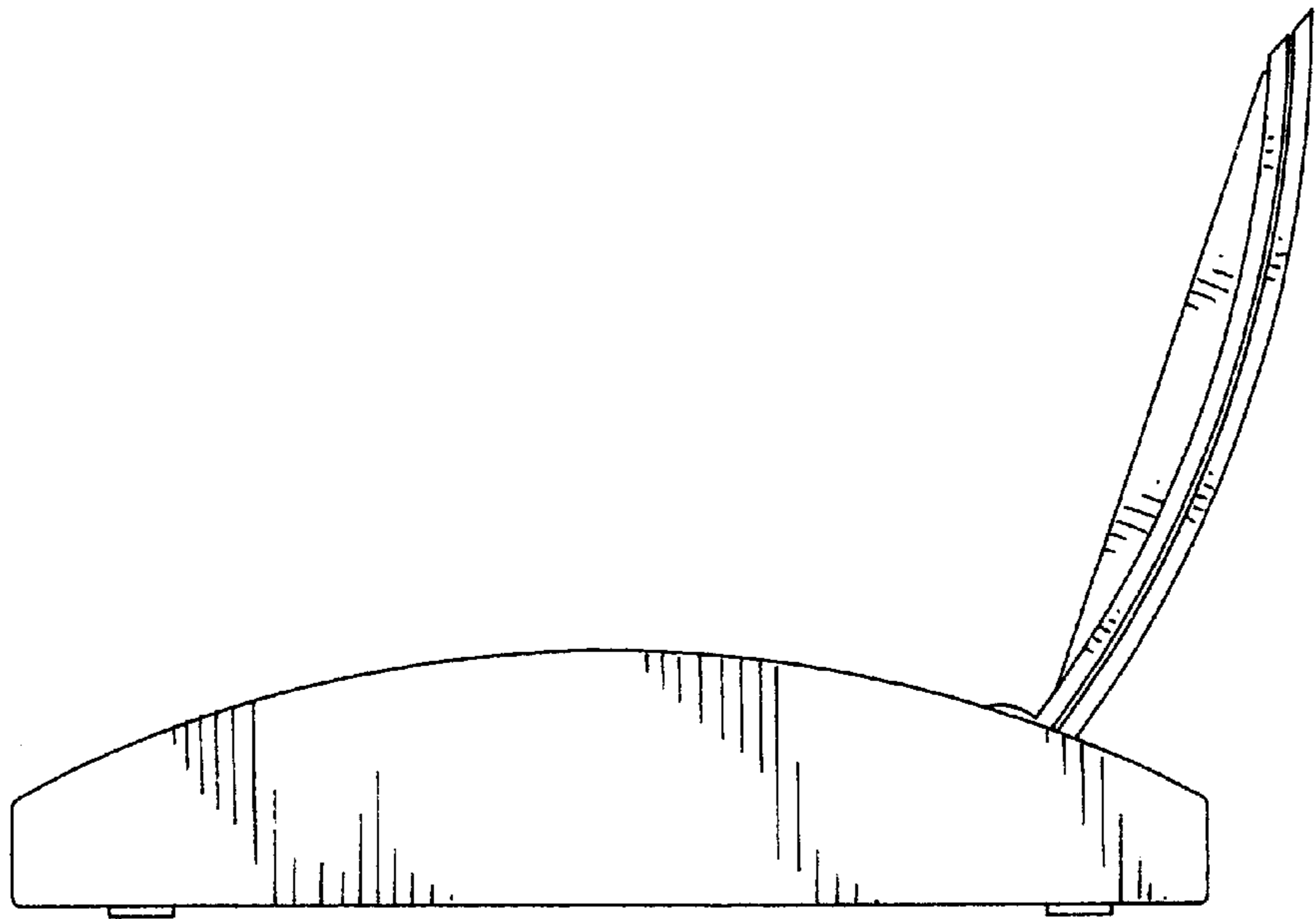

FIG. 15

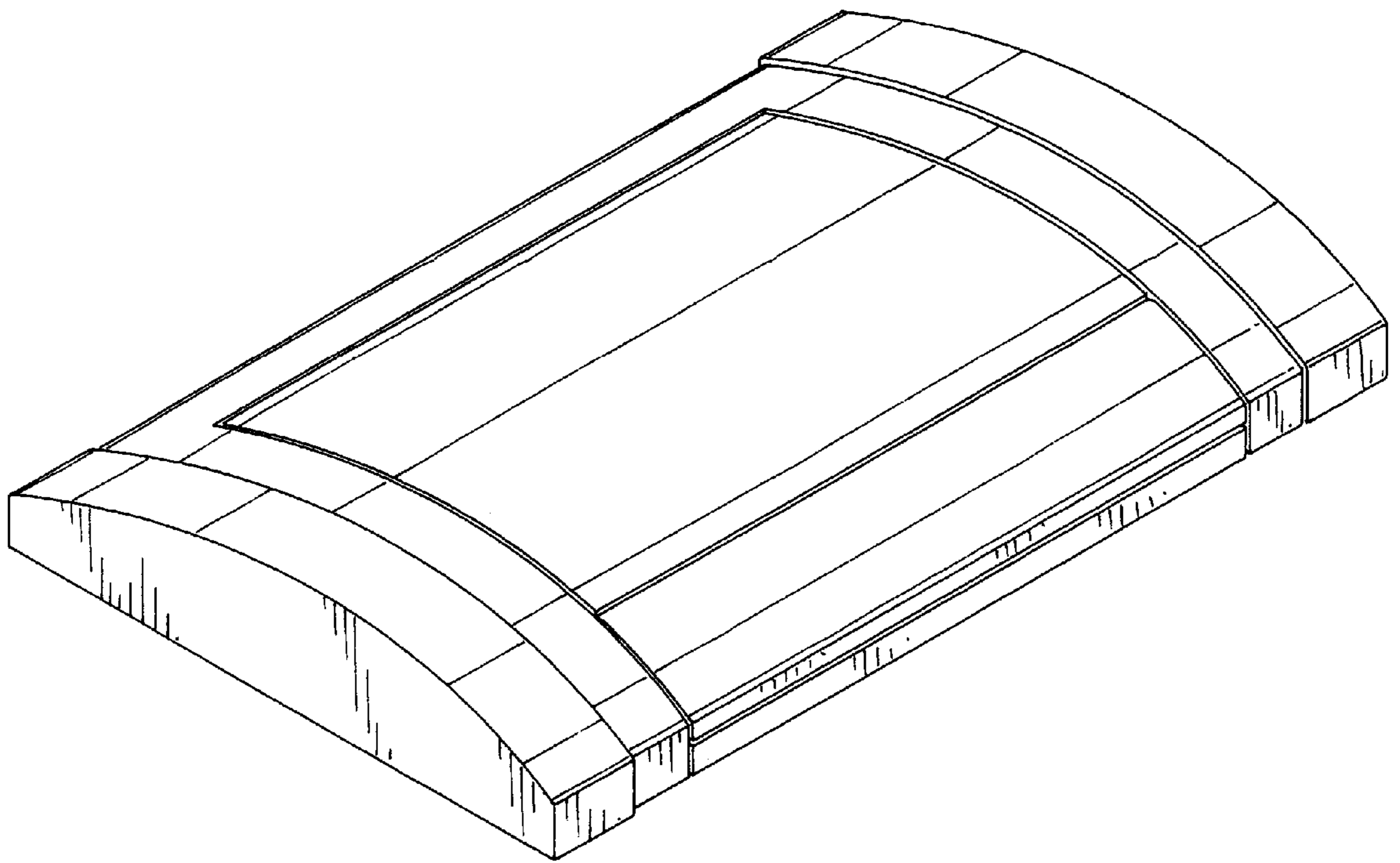

FIG. 16