



US00D429243S

United States Patent [19] Hancock

[11] **Patent Number: Des. 429,243**

[45] **Date of Patent: ** Aug. 8, 2000**

[54] **PERSONAL COMPUTER**

[75] Inventor: **Ronald Lee Hancock**, Sioux City, Iowa

[73] Assignee: **Gateway 2000, Inc.**, North Sioux City, S. Dak.

[**] Term: **14 Years**

[21] Appl. No.: **29/034,516**

[22] Filed: **Feb. 6, 1995**

[51] **LOC (7) Cl. 14-02**

[52] **U.S. Cl. D14/348**

[58] **Field of Search** D14/100, 102, D14/107-109; D13/162, 184, 199; 312/208.1; 360/97.01, 97.04, 98.01, 99.01, 99.12; 361/694

[56] **References Cited**

U.S. PATENT DOCUMENTS

- D. 317,445 6/1991 Sacherman D14/100 X
- D. 340,444 10/1993 Kuba et al. D14/100
- D. 358,134 5/1995 Kimbrough et al. D14/100

Primary Examiner—Freda Nunn

Attorney, Agent, or Firm—Schwegman, Lundberg, Woessner & Kluth P.A.; Anthony Claiborne

[57] **CLAIM**

The ornamental design for a personal computer, as shown and described.

DESCRIPTION

FIG. 1 is a front view of a personal computer showing the new design;

FIG. 2 is a rear view thereof;

FIG. 3 is a top plan view thereof;

FIG. 4 is a bottom plan view thereof;

FIG. 5 is a right side elevation thereof;

FIG. 6 is a left side elevation thereof;

FIG. 7 is a front view of a second embodiment of the new design;

FIG. 9 is a top plan view thereof;

FIG. 10 is a bottom plan view thereof;

FIG. 11 is a right side elevation thereof;

FIG. 12 is a left side elevation thereof; and,

FIG. 13 is an upper left frontal perspective view of the first embodiment.

FIG. 14 is an upper right frontal perspective view of the second embodiment.

1 Claim, 8 Drawing Sheets

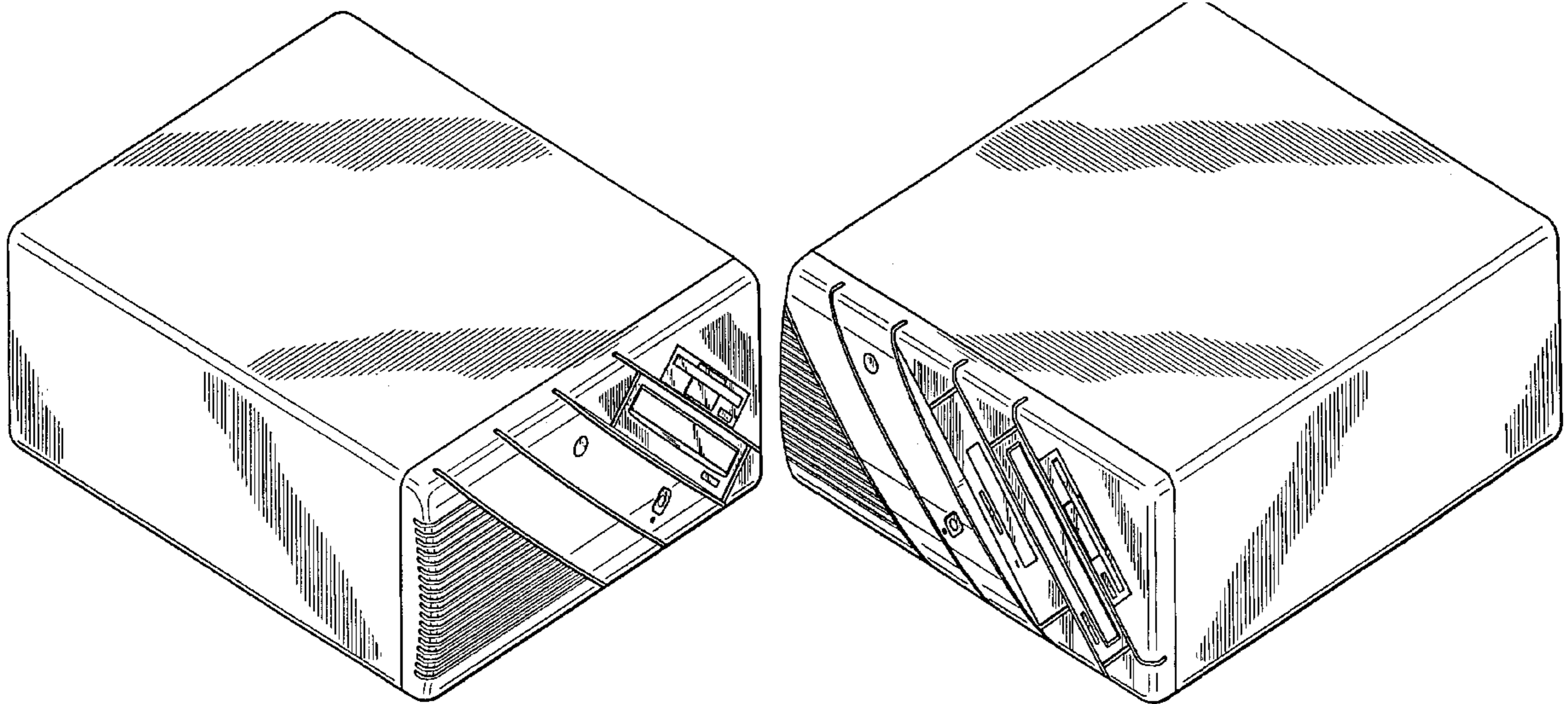

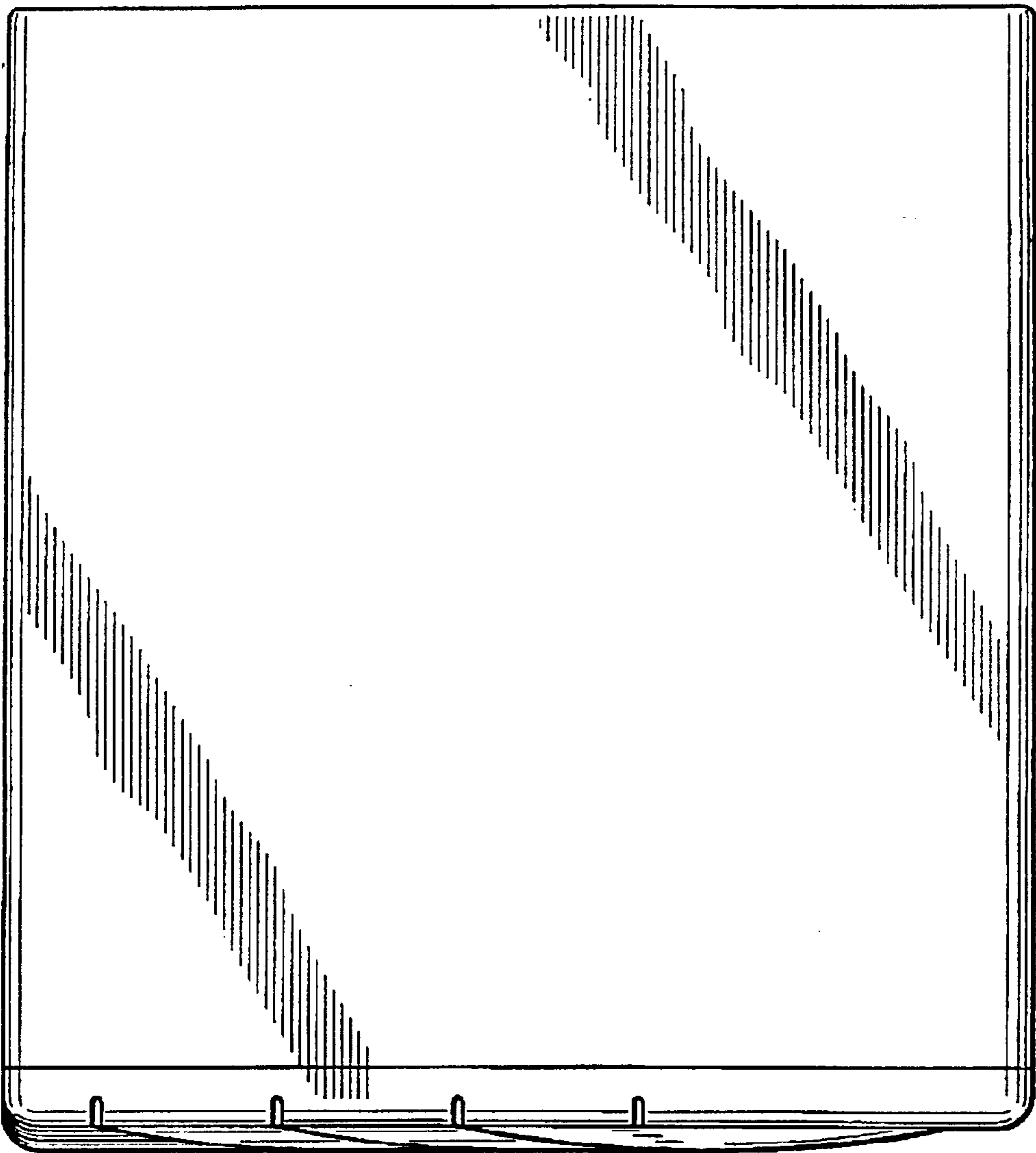

FIG. 3

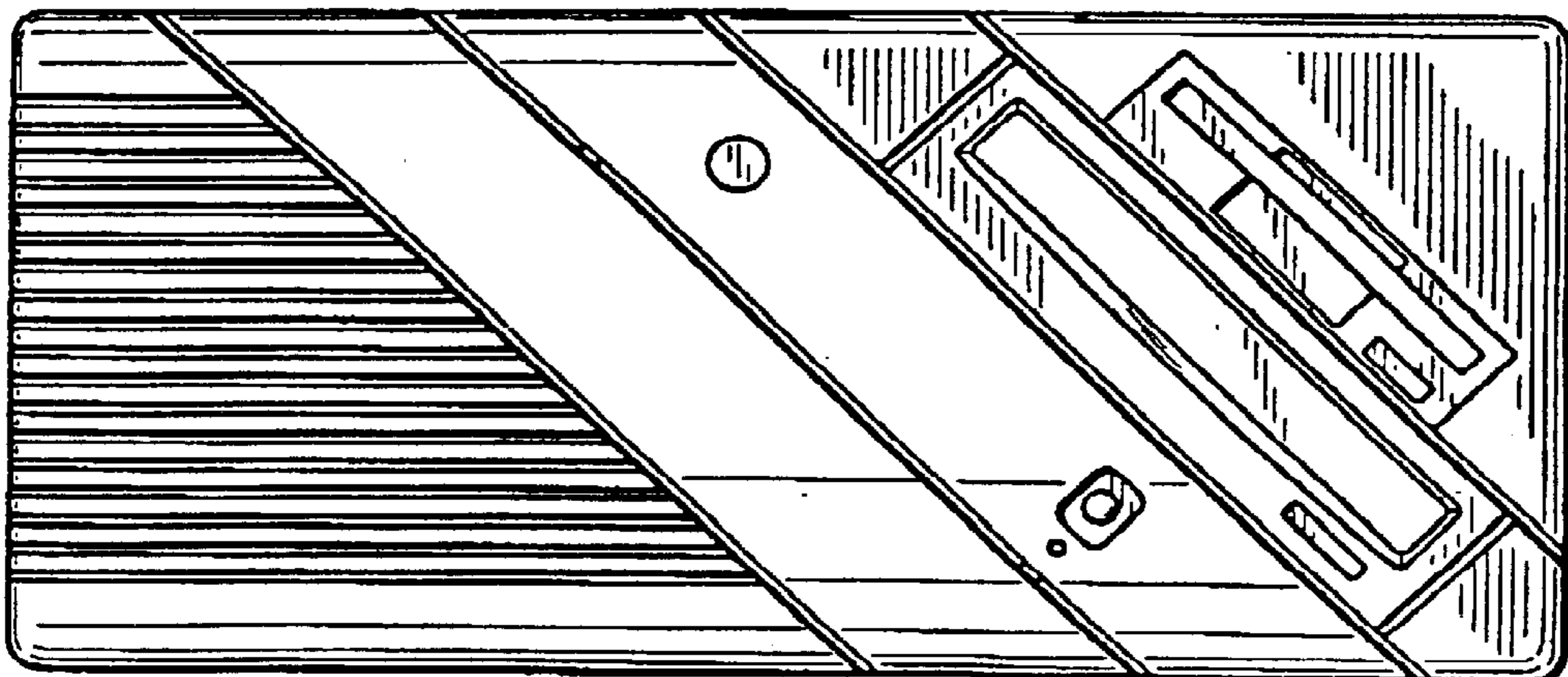

FIG. 1

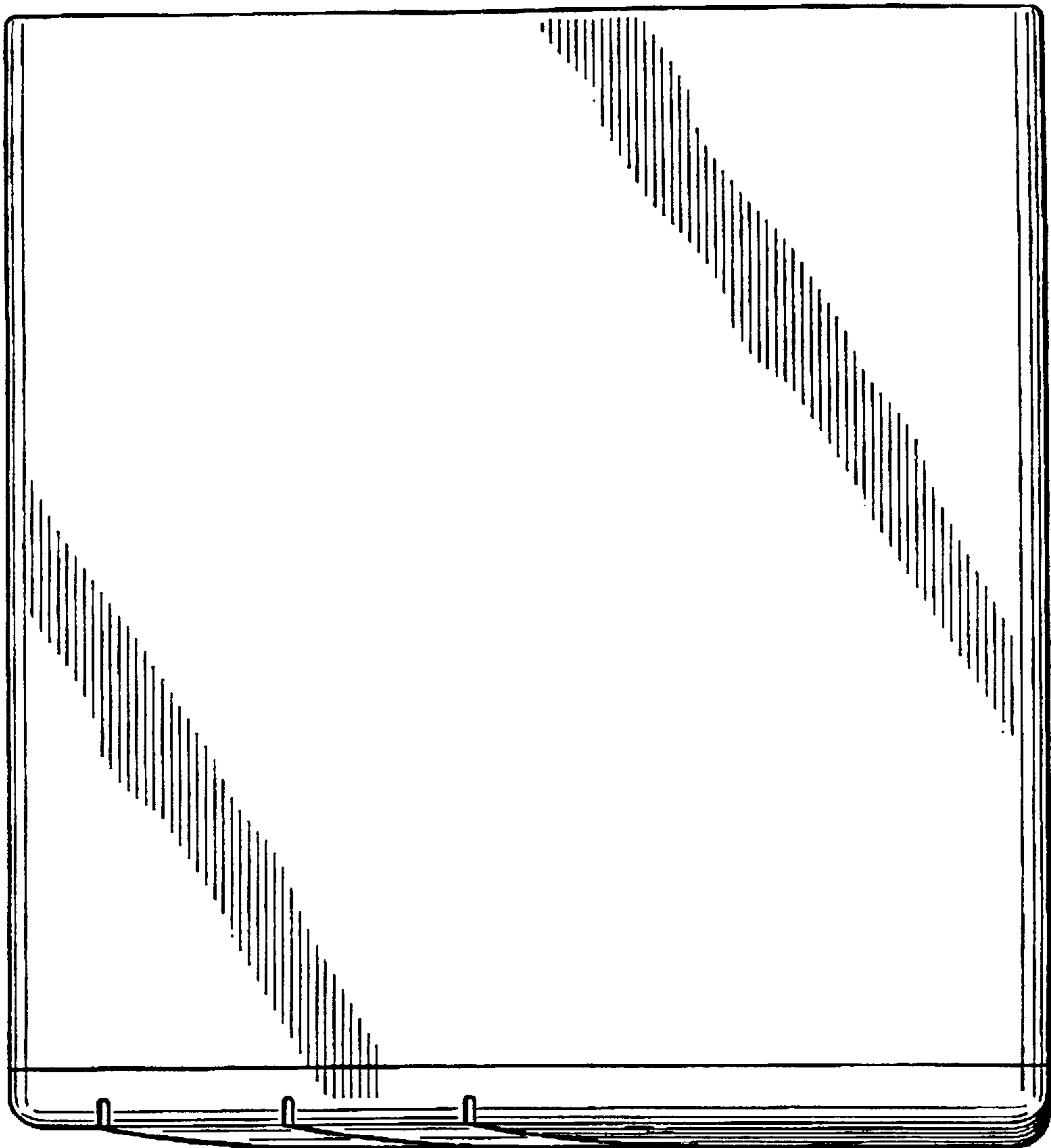

FIG. 4

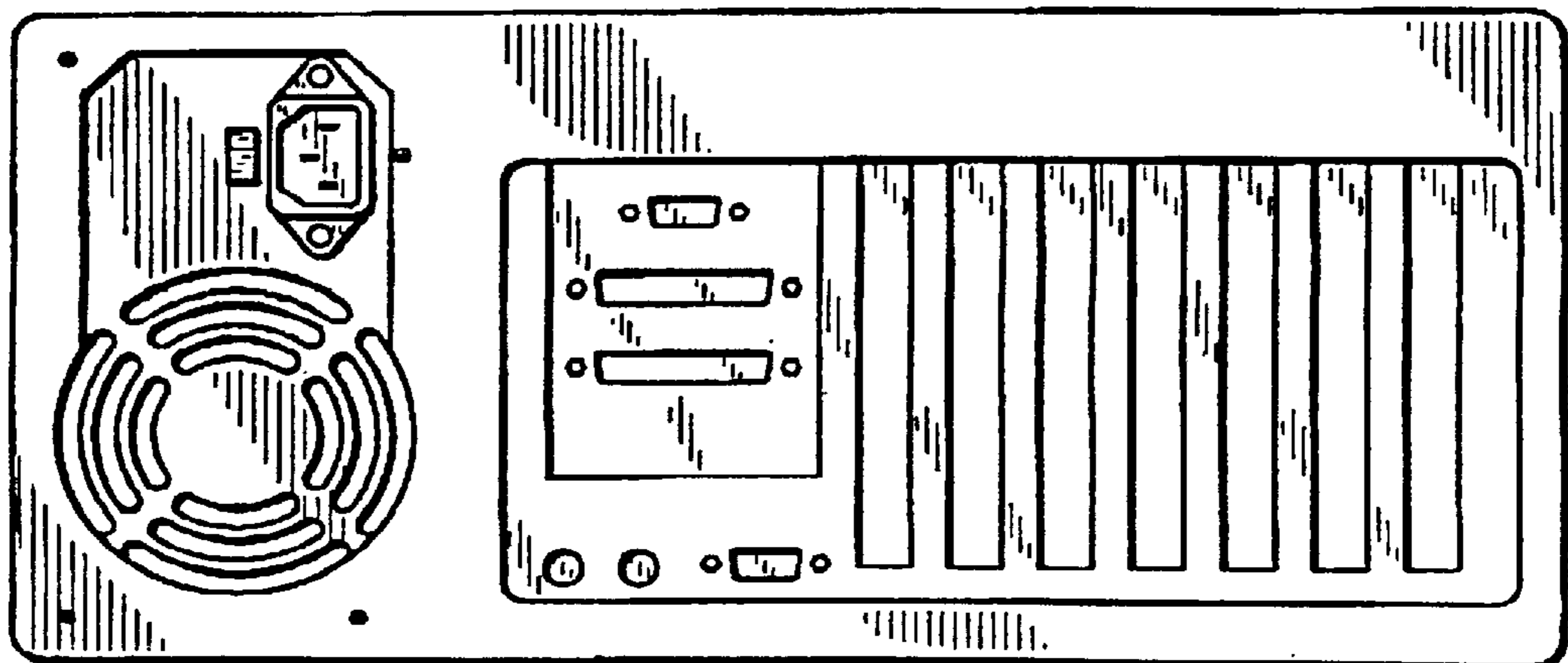

FIG. 2

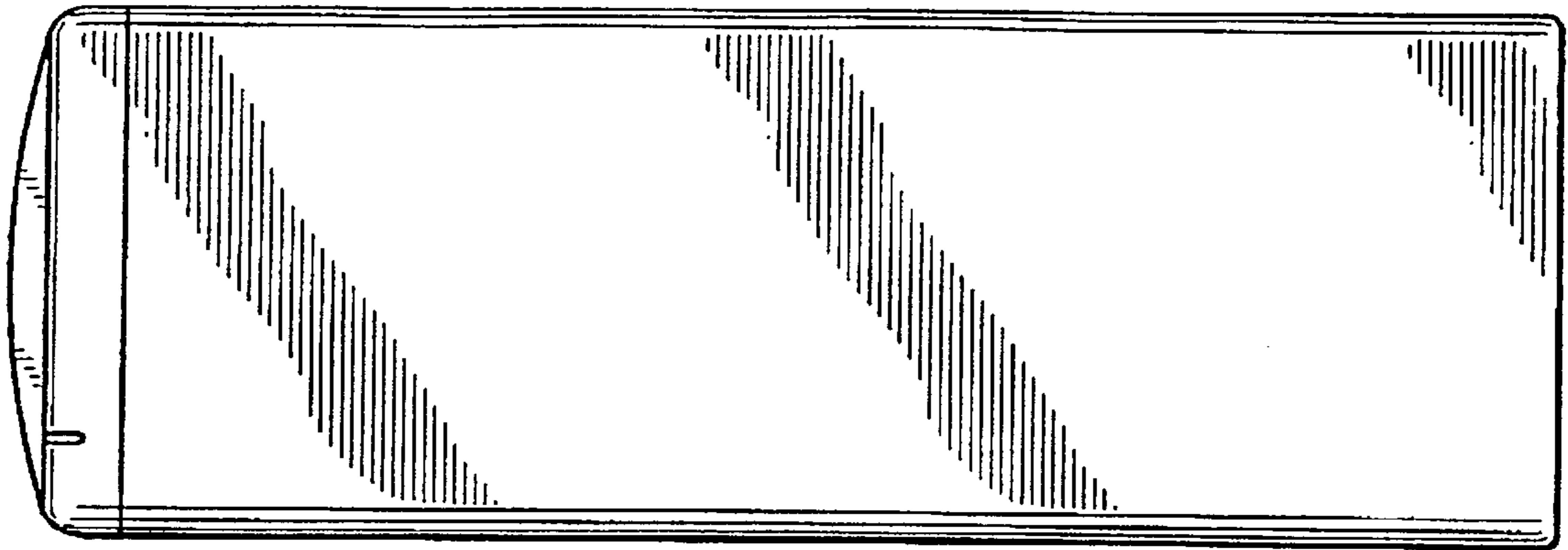

FIG. 5

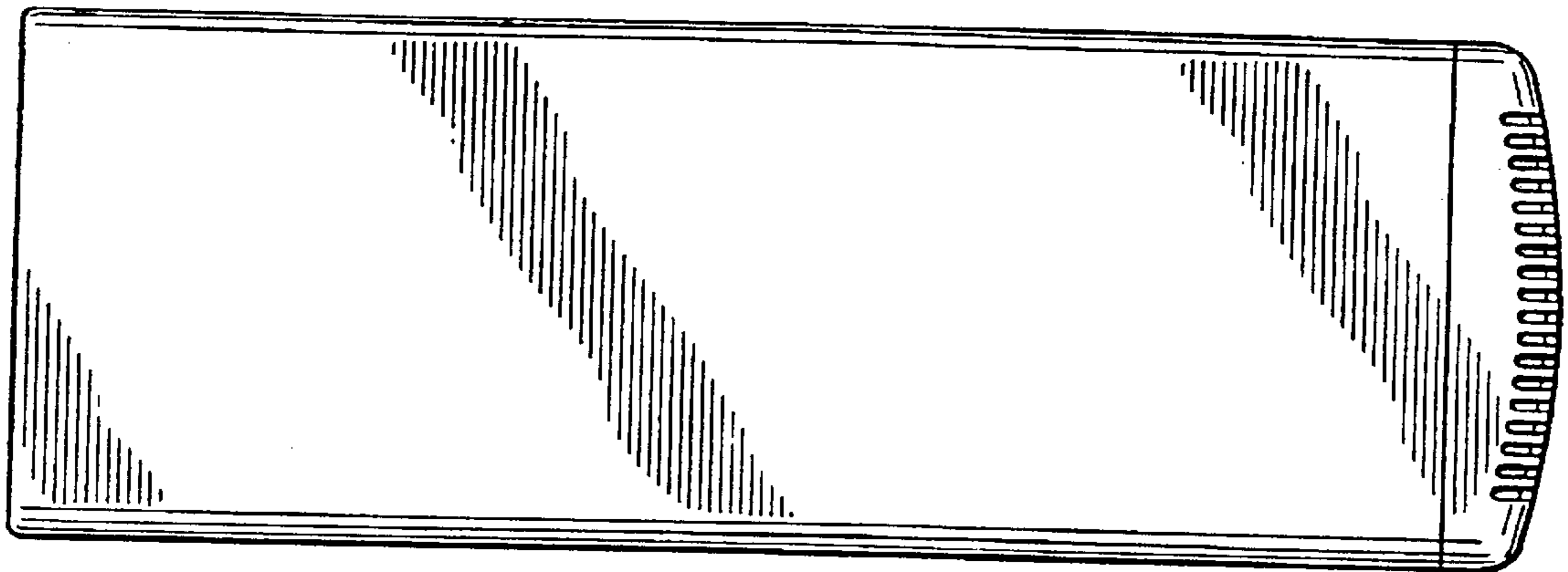

FIG. 6

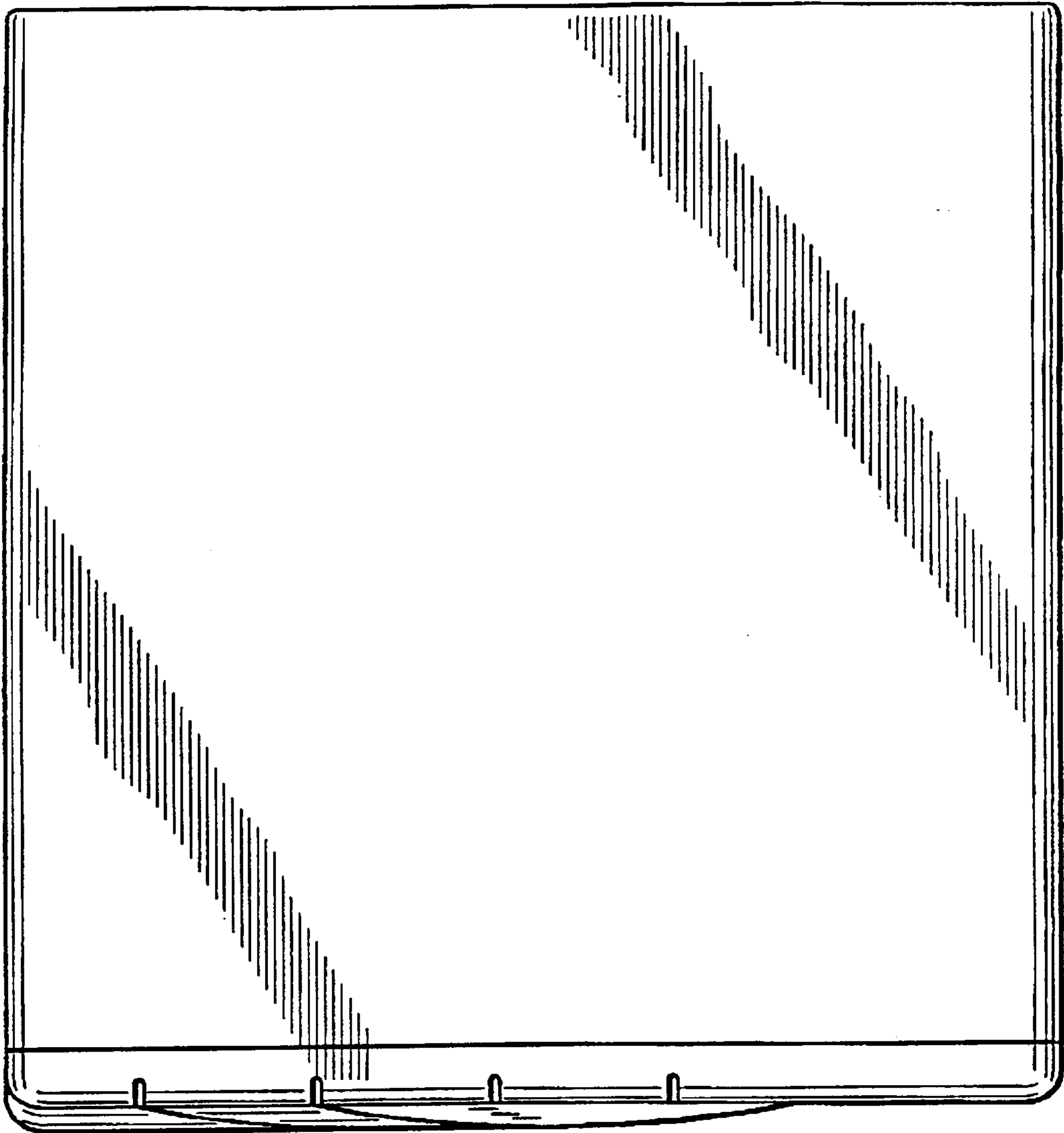

FIG. 9

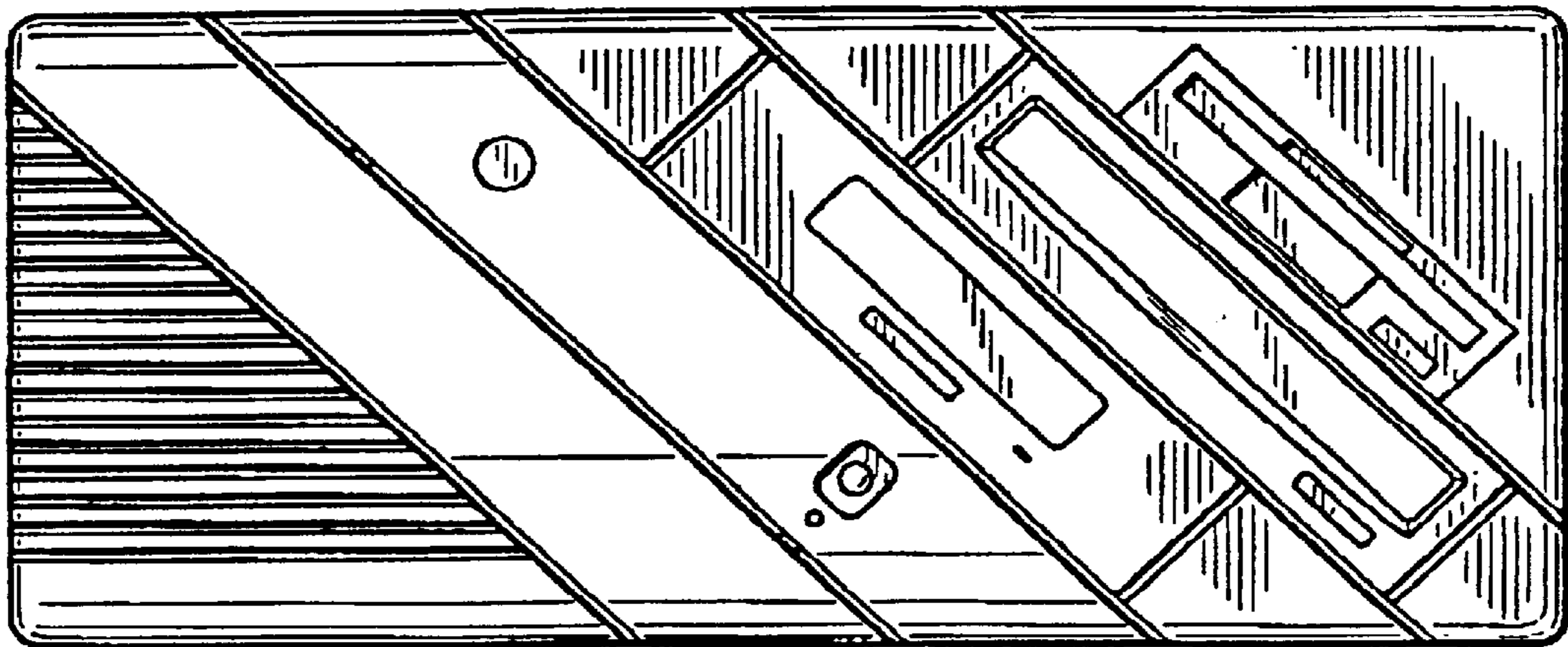

FIG. 7

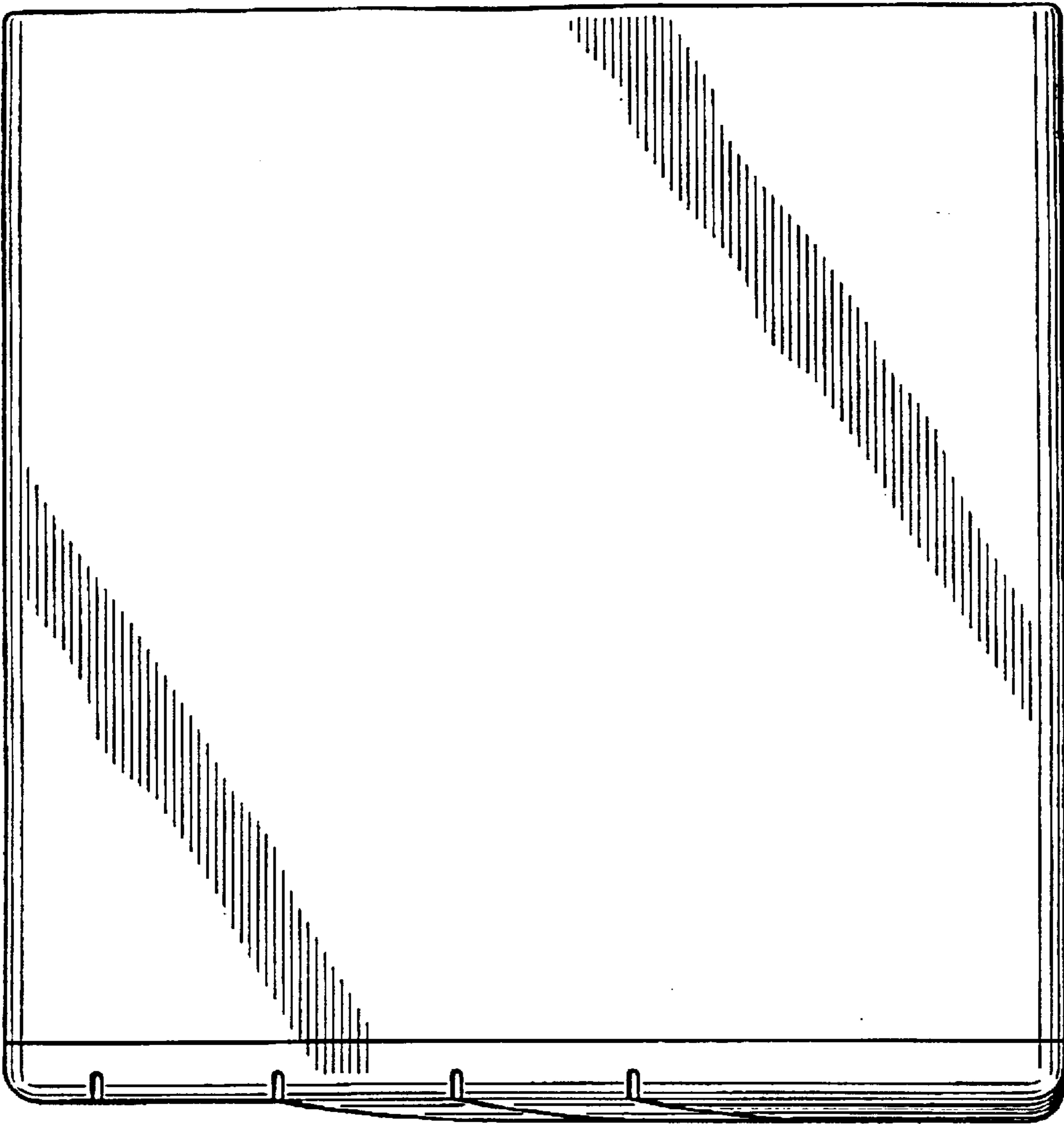

FIG. 10

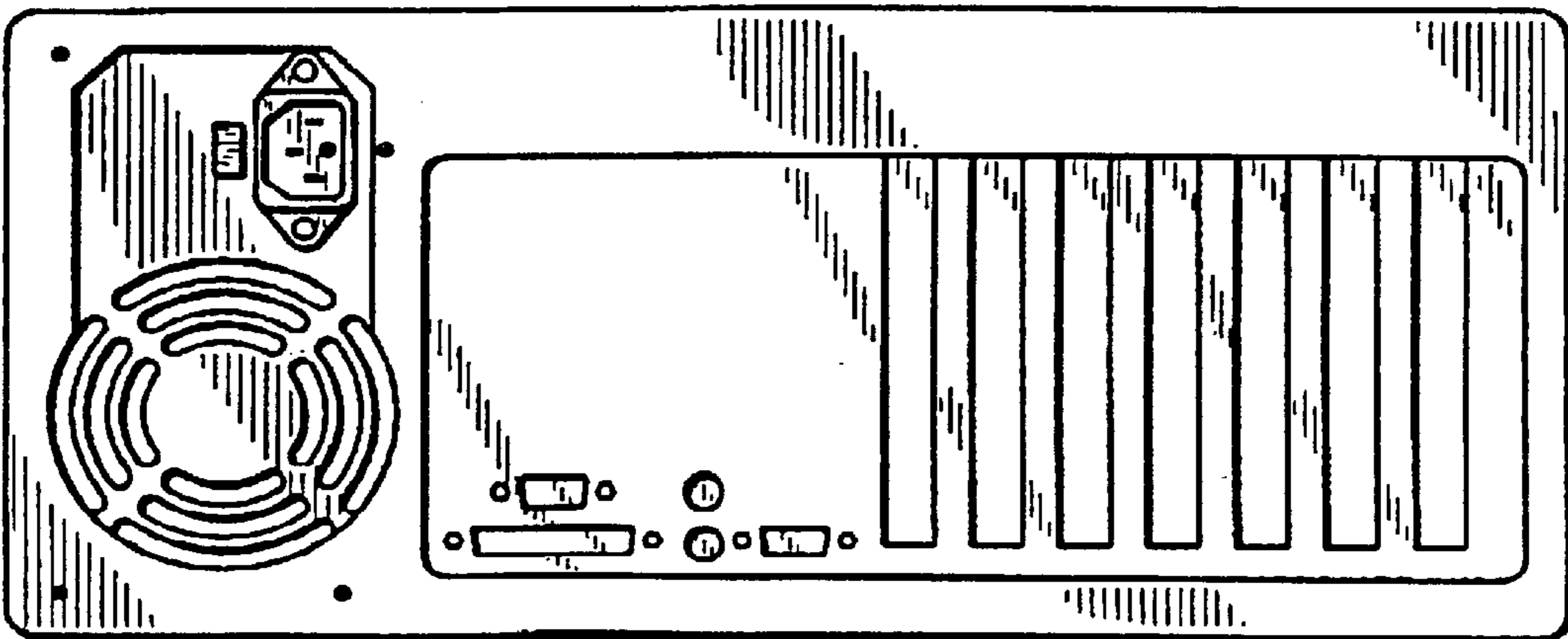

FIG. 8

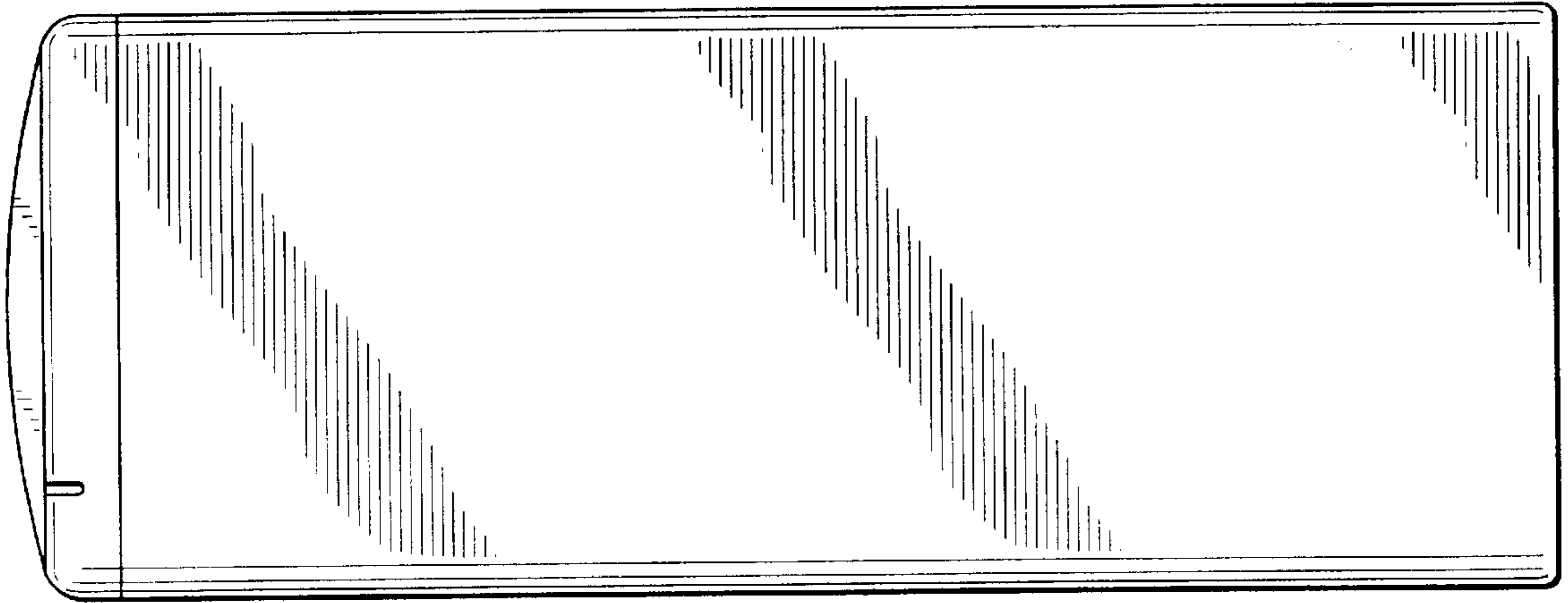

FIG. 11

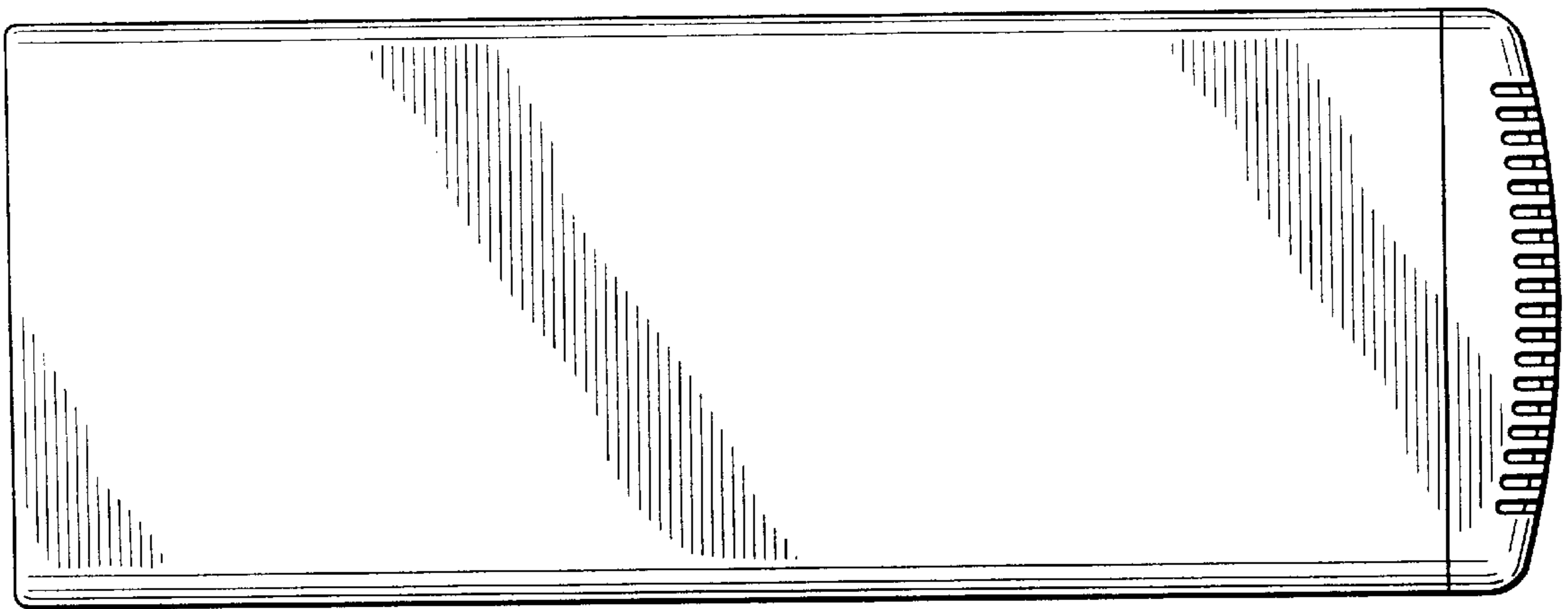

FIG. 12

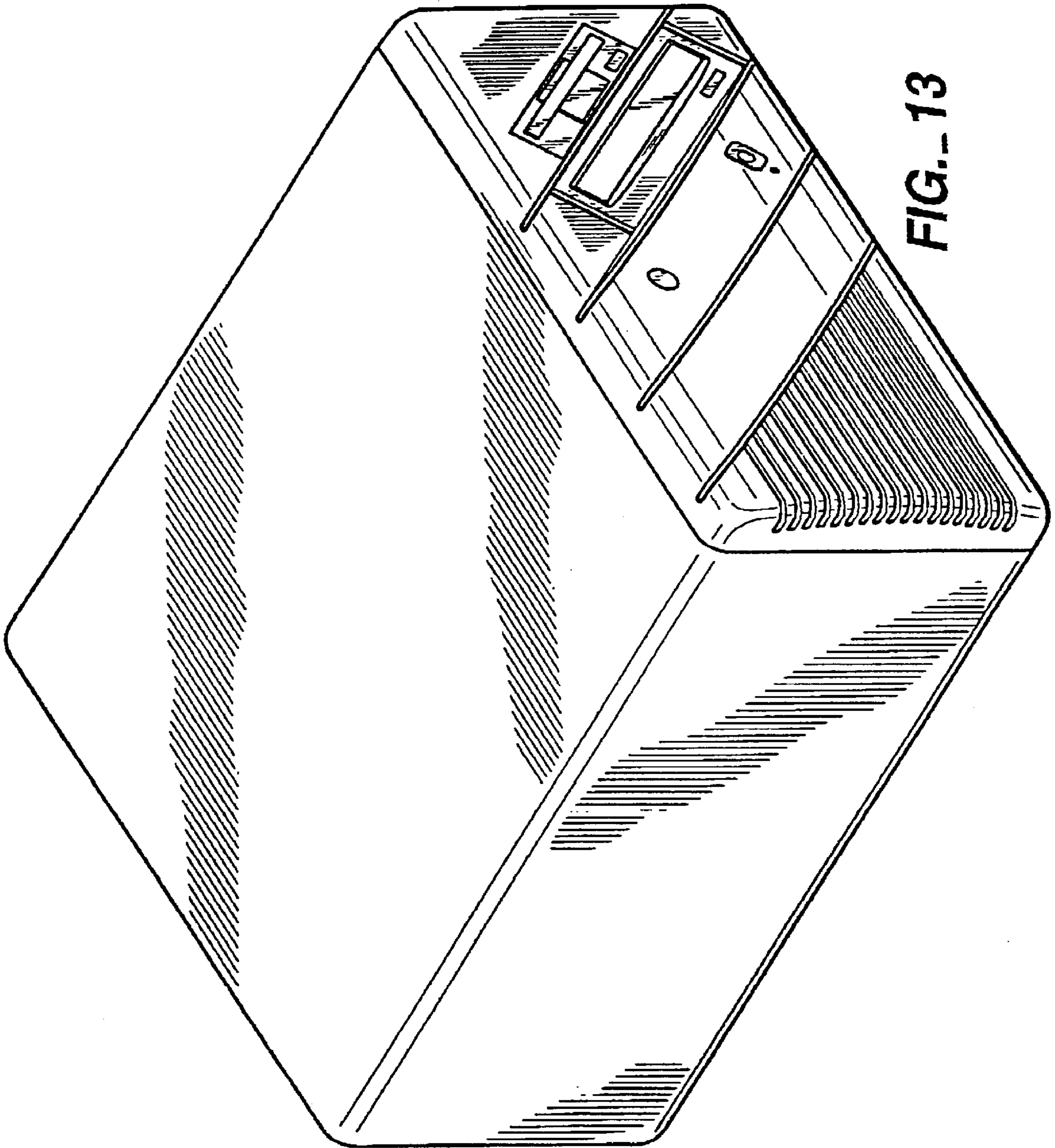

FIG. 13

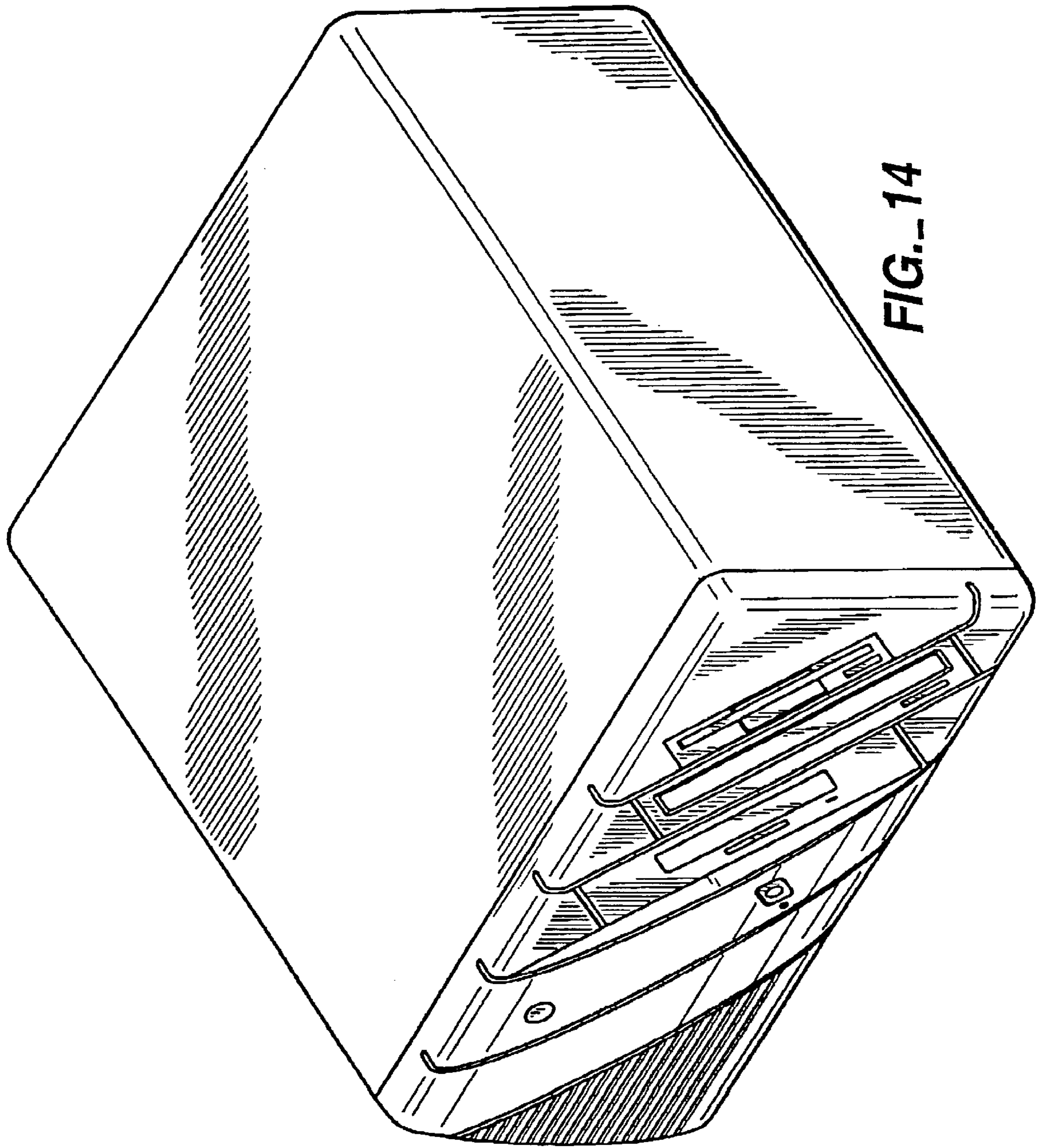

FIG. 14