



US00D429237S

United States Patent [19] Cho

[11] Patent Number: **Des. 429,237**

[45] Date of Patent: **** Aug. 8, 2000**

[54] SPEAKER SYSTEM

[75] Inventor: **Chung Dong Cho**, Kyungki-do, Rep. of Korea

[73] Assignee: **Eastern Acoustic Corp.**, Kyungki-do, Rep. of Korea

[**] Term: **14 Years**

[21] Appl. No.: **29/107,760**

[22] Filed: **Jul. 13, 1999**

[51] LOC (7) Cl. **14-01**

[52] U.S. Cl. **D14/214**

[58] Field of Search D14/168, 204,
D14/207, 209-216; 181/144-148, 150,
157, 198-199; 381/300-302, 307, 332-336,
359

[56] References Cited

U.S. PATENT DOCUMENTS

D. 335,130	4/1993	Rozier	D14/214
D. 382,877	8/1997	Cheng	D14/214
D. 392,977	3/1998	Kim	D14/214
D. 400,531	11/1998	Kokkinis	D14/168
D. 400,883	11/1998	Jung	D14/214
5,067,583	11/1991	Hathaway	D14/214 X

Primary Examiner—Nanda Bondade
Attorney, Agent, or Firm—McAulay Nissen Goldberg & Kiel, LLP

[57] CLAIM

The ornamental design for a speaker system, as shown and described.

DESCRIPTION

FIG. 1 is an exploded perspective view of a speaker system showing my new design comprising a central, right side and a left side parts, with the upper portion of the left side part shown in a rotated position;

FIG. 2 is a front, top and right side perspective view of the central part of the speaker system, shown separately for clarity of illustration;

FIG. 3 is an exploded perspective view of FIG. 2;

FIG. 4 is a front view of FIG. 2;

FIG. 5 is a top view of FIG. 2;

FIG. 6 is a left side view of FIG. 2;

FIG. 7 is a right side view of FIG. 2;

FIG. 8 is bottom view of FIG. 2;

FIG. 9 is a rear view of FIG. 2;

FIG. 10 is a perspective view of the right side part shown on FIG. 1, shown separately for clarity of illustration;

FIG. 11 is a front view of FIG. 10;

FIG. 12 is a right side view of FIG. 10, the left side being a mirror image;

FIG. 13 is a rear view of FIG. 10; and,

FIG. 14 is a bottom view of FIG. 10, the top view being identical.

The left side part shown on FIG. 1 is identical to the right side part shown on FIGS. 10-14.

The surface(s) or portion(s) of the article not shown in the drawing or described in the specification form(s) no part of the claimed design.

1 Claim, 7 Drawing Sheets

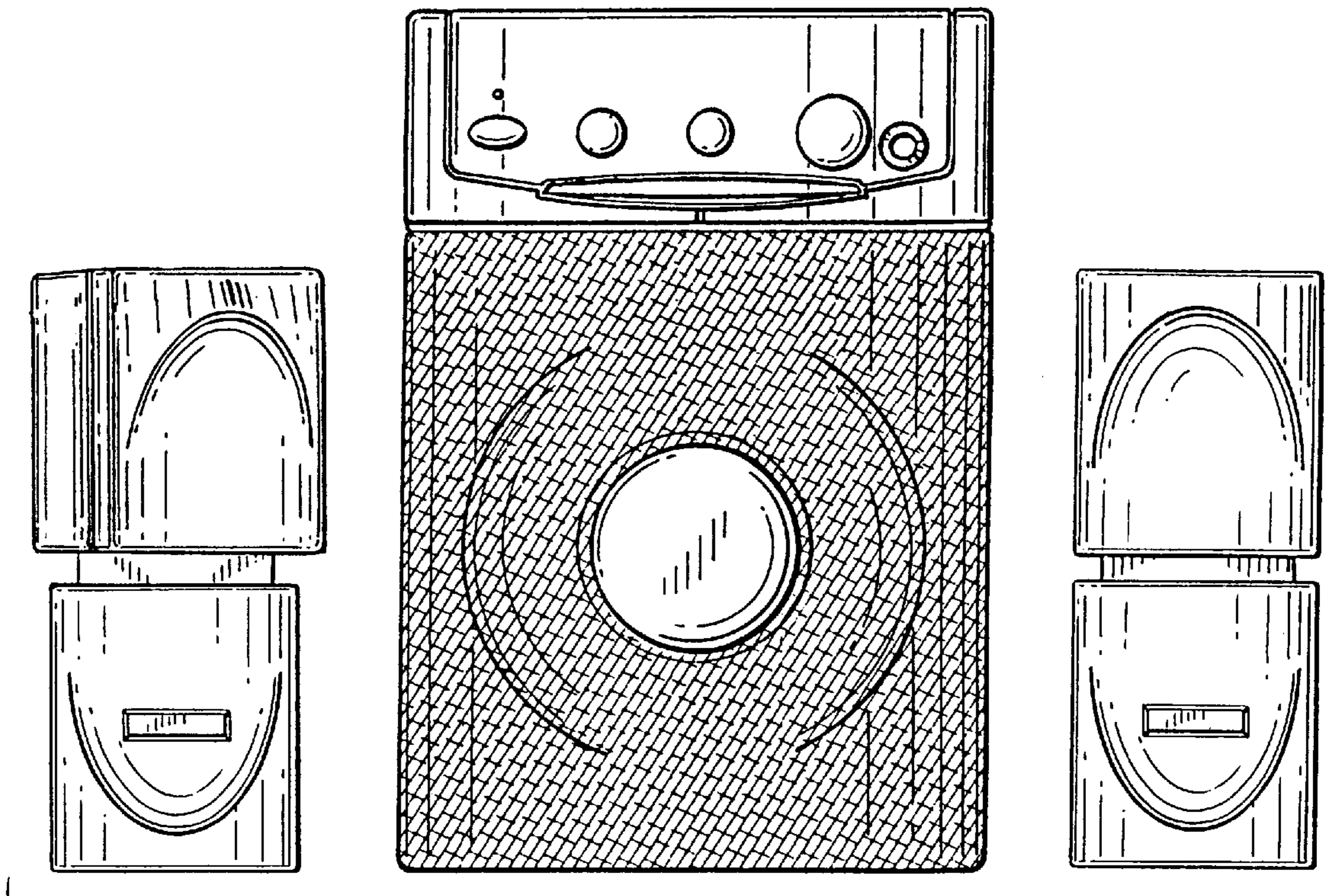

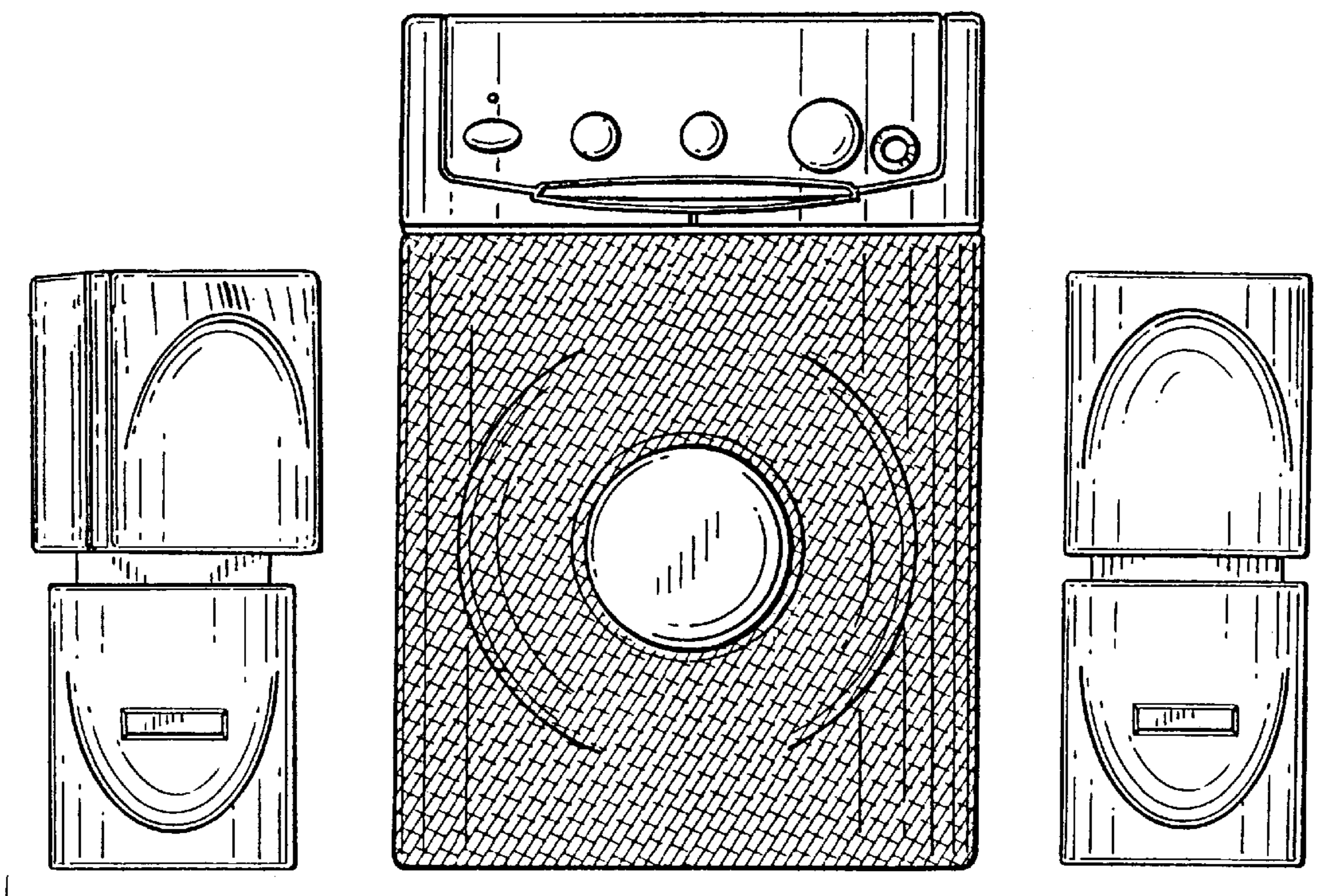

FIG. 1

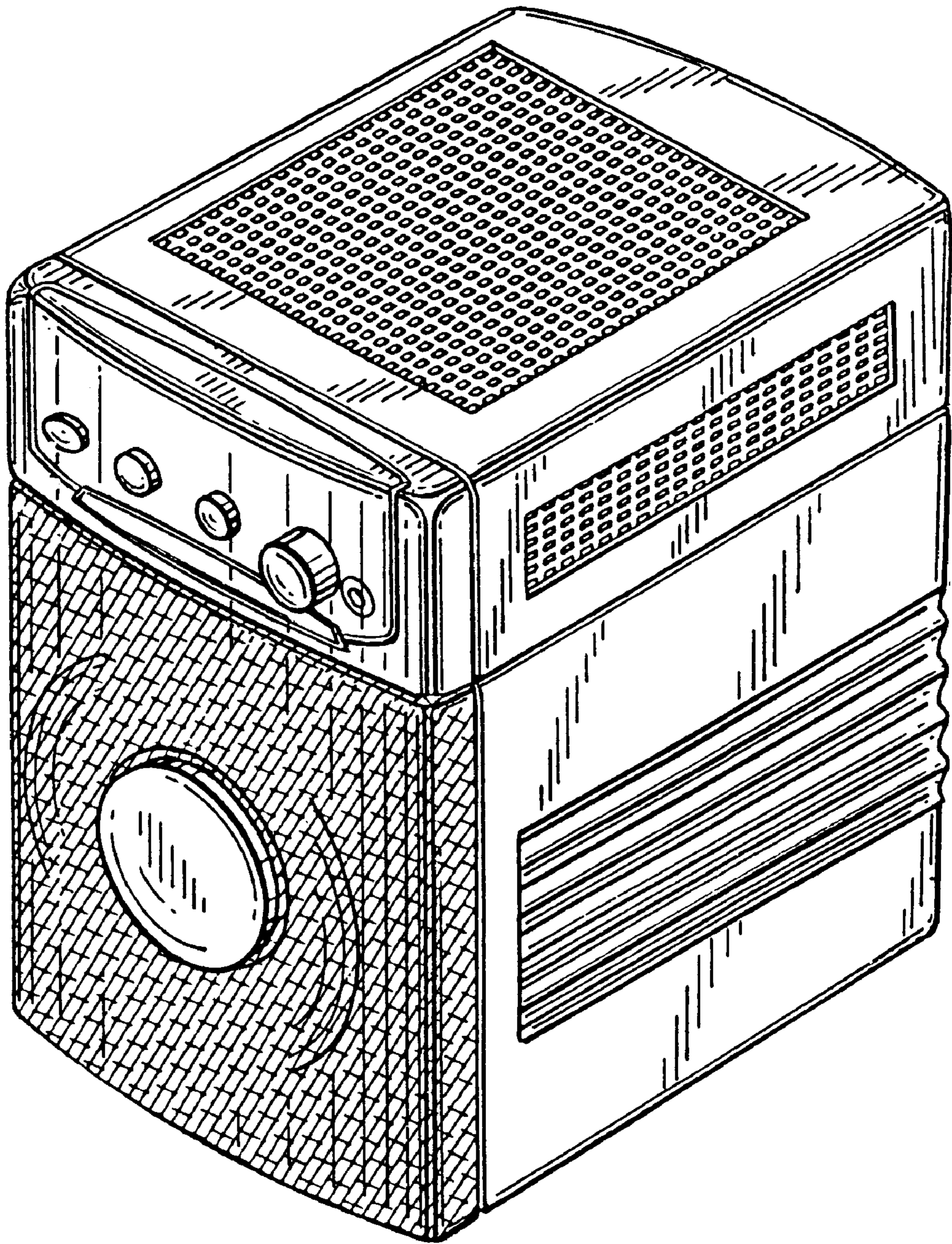

FIG. 2

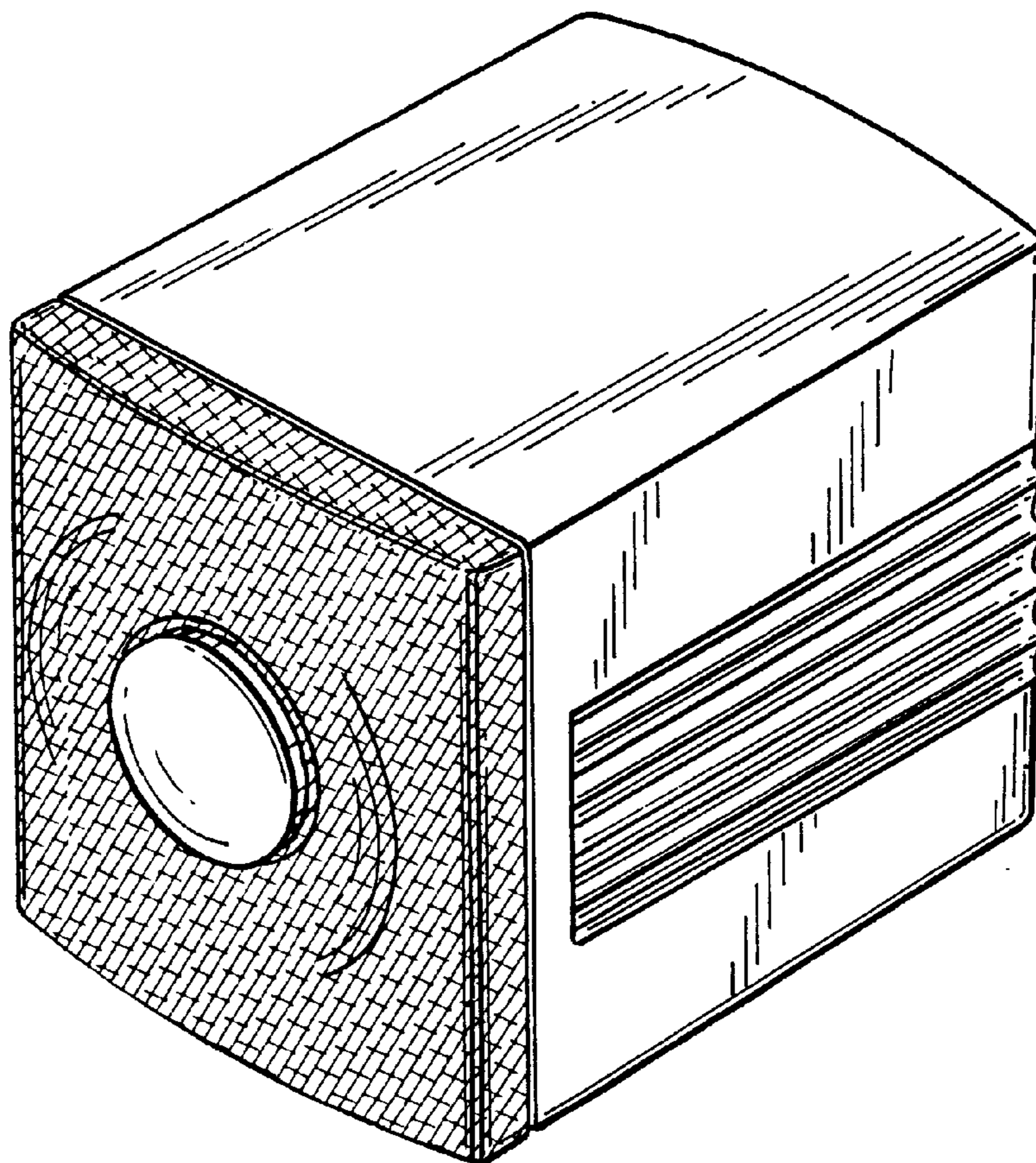
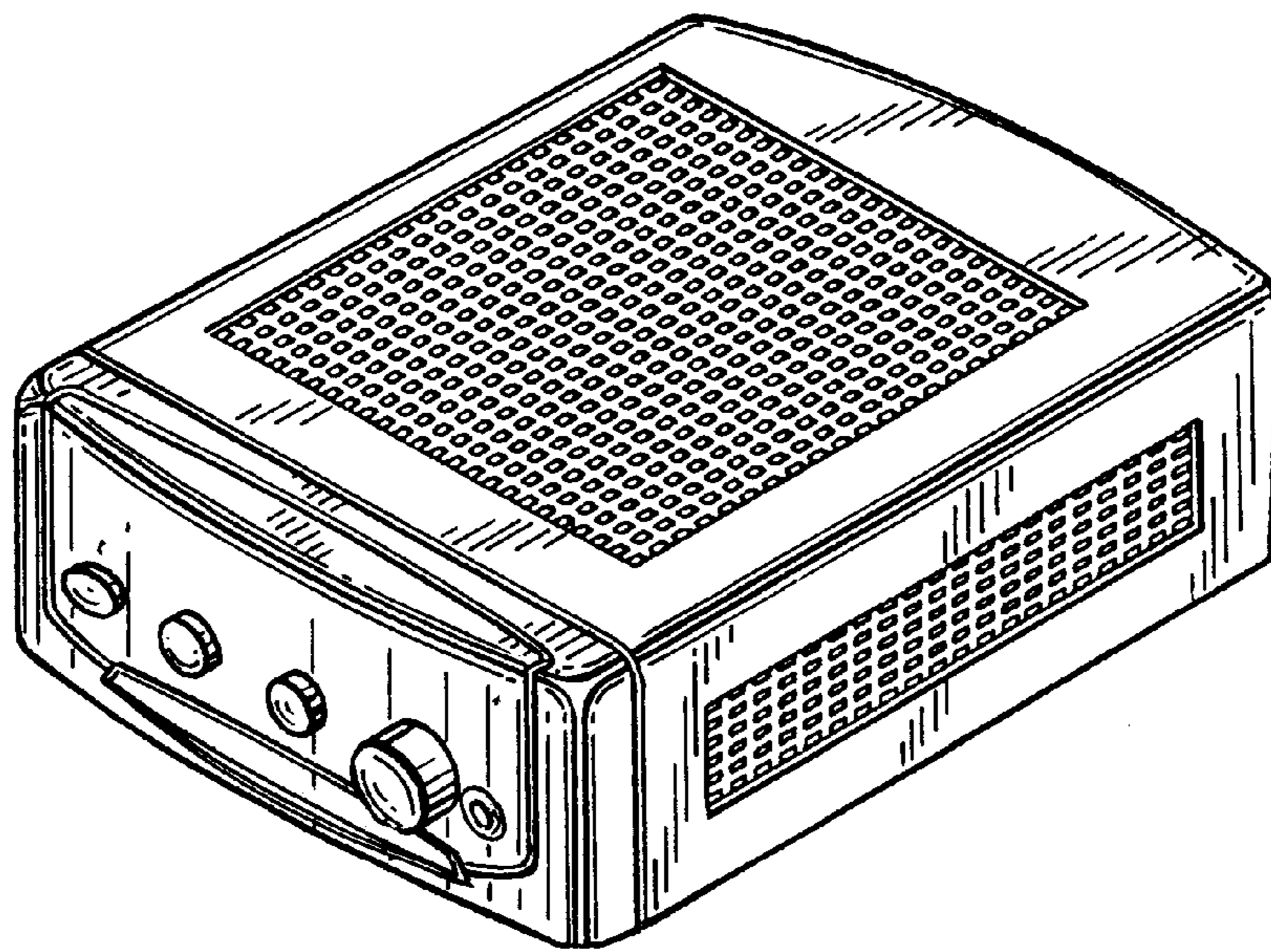

FIG. 3

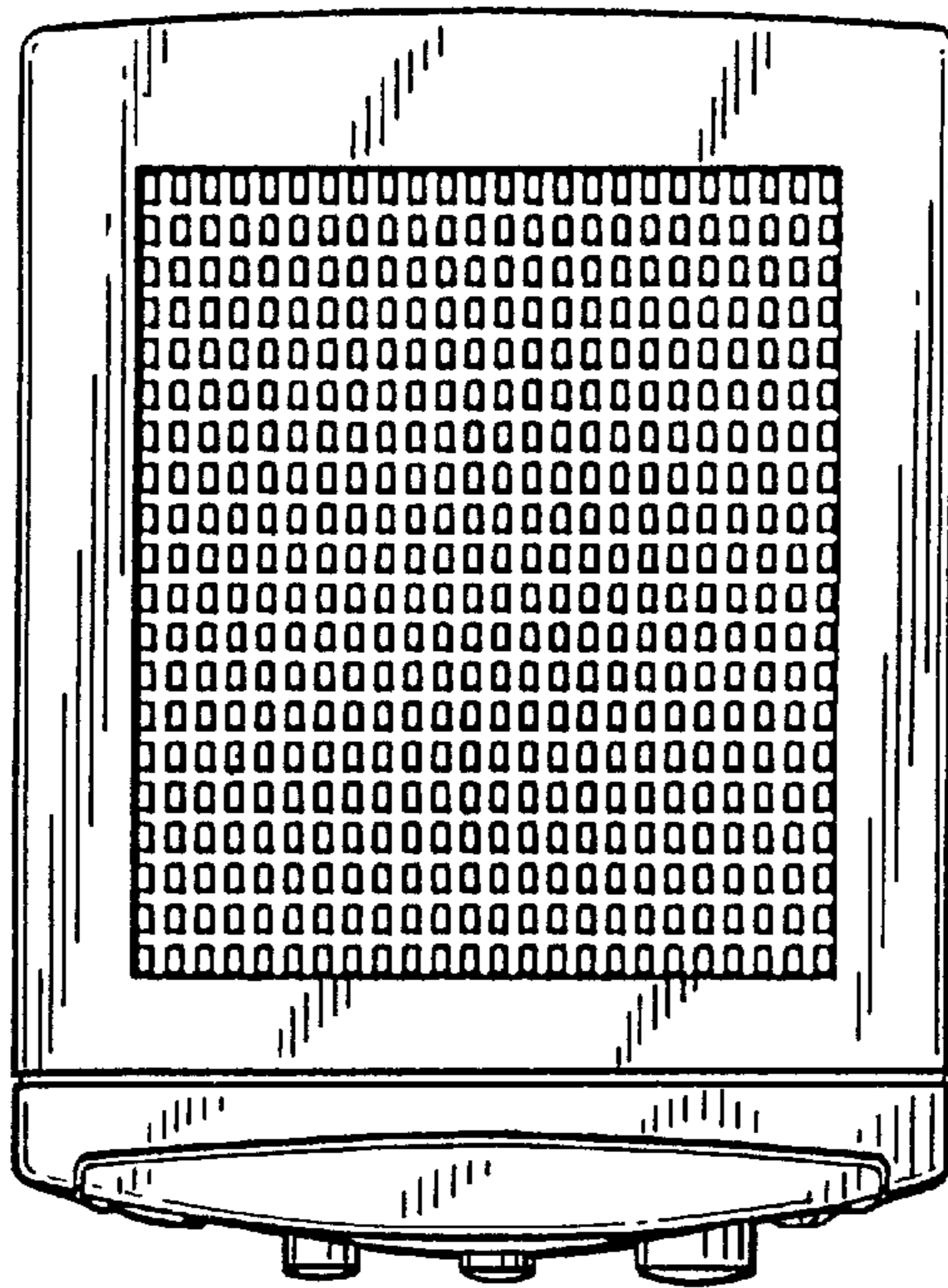

FIG. 5

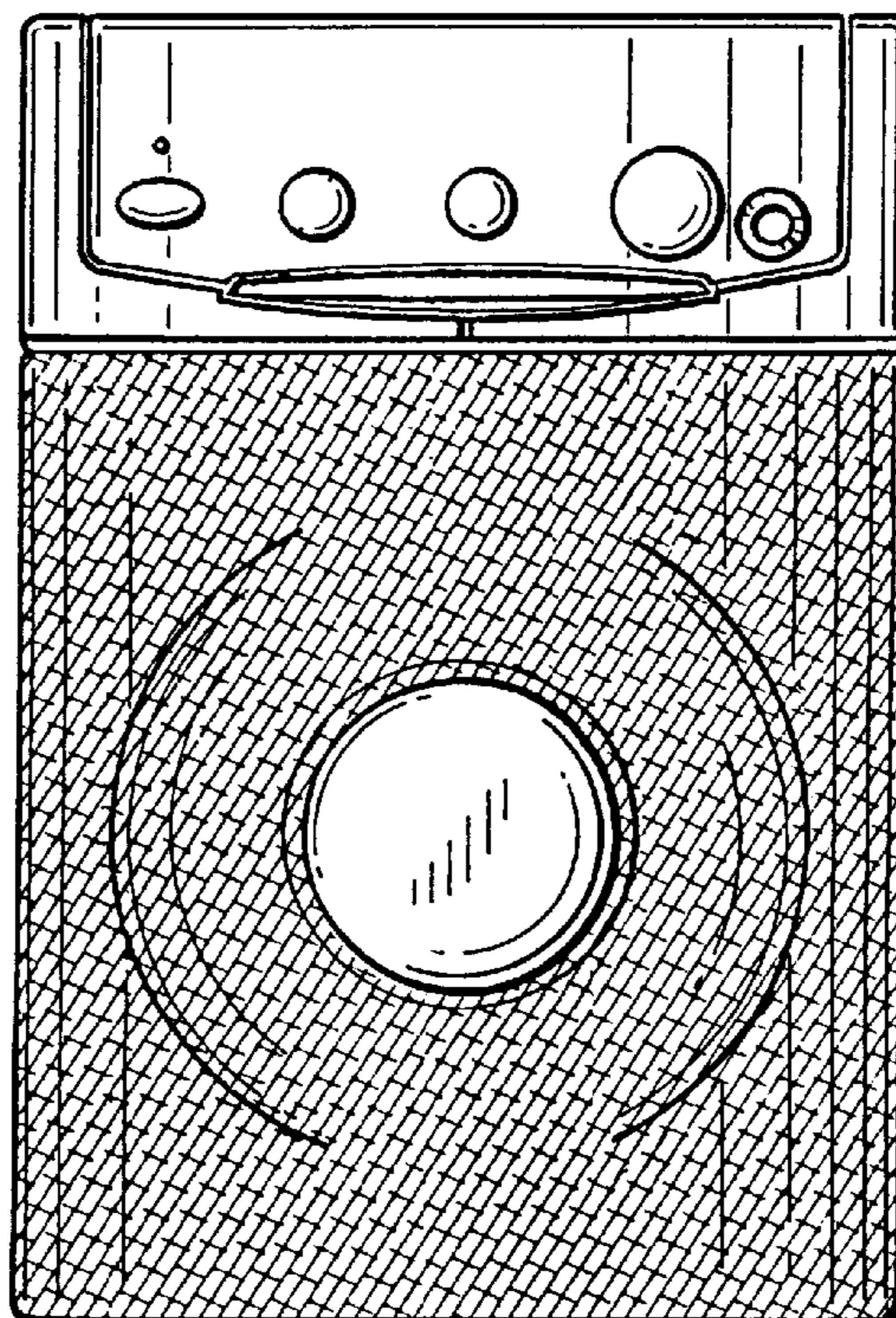

FIG. 4

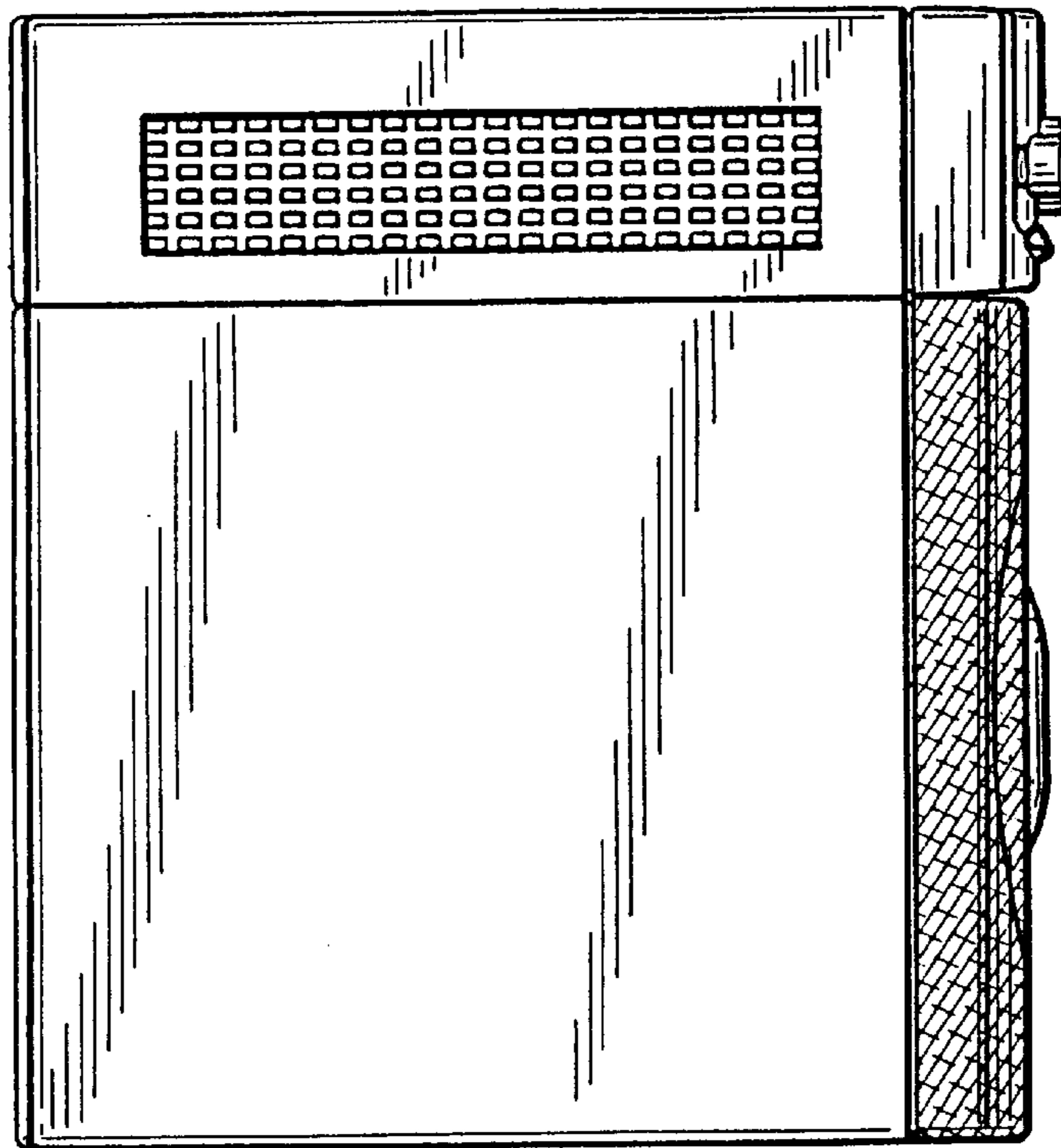

FIG. 6

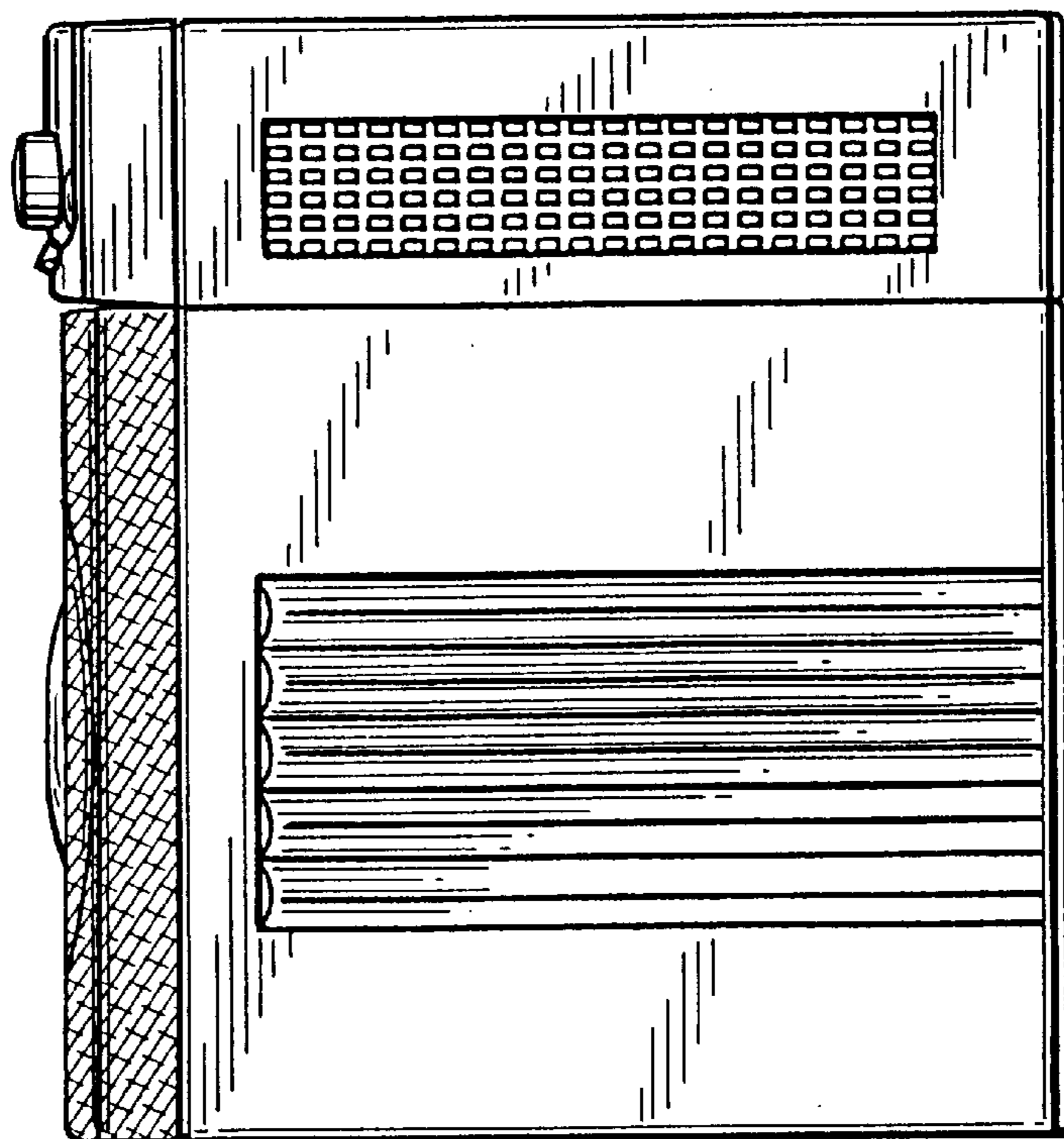

FIG. 7

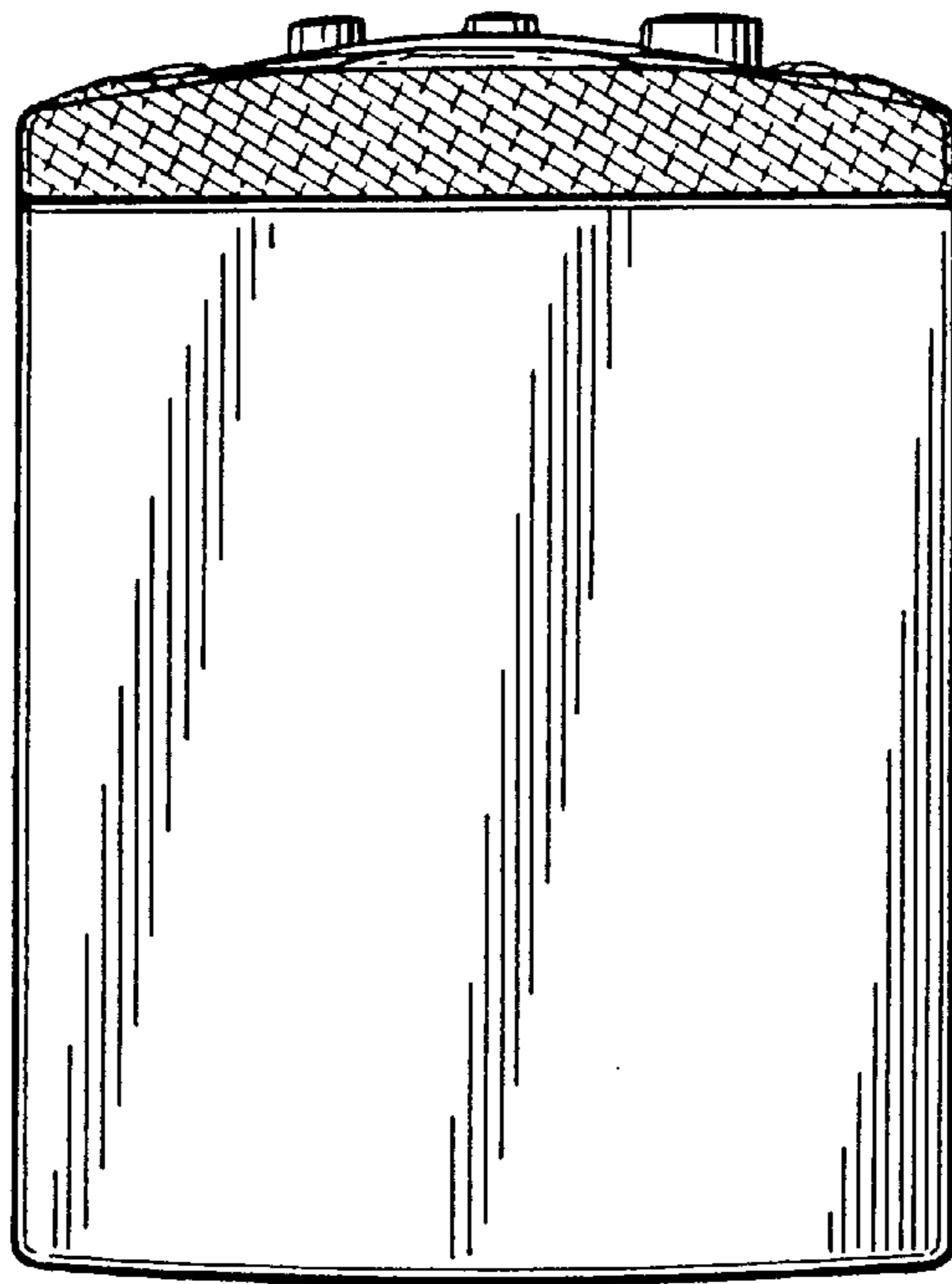

FIG. 8

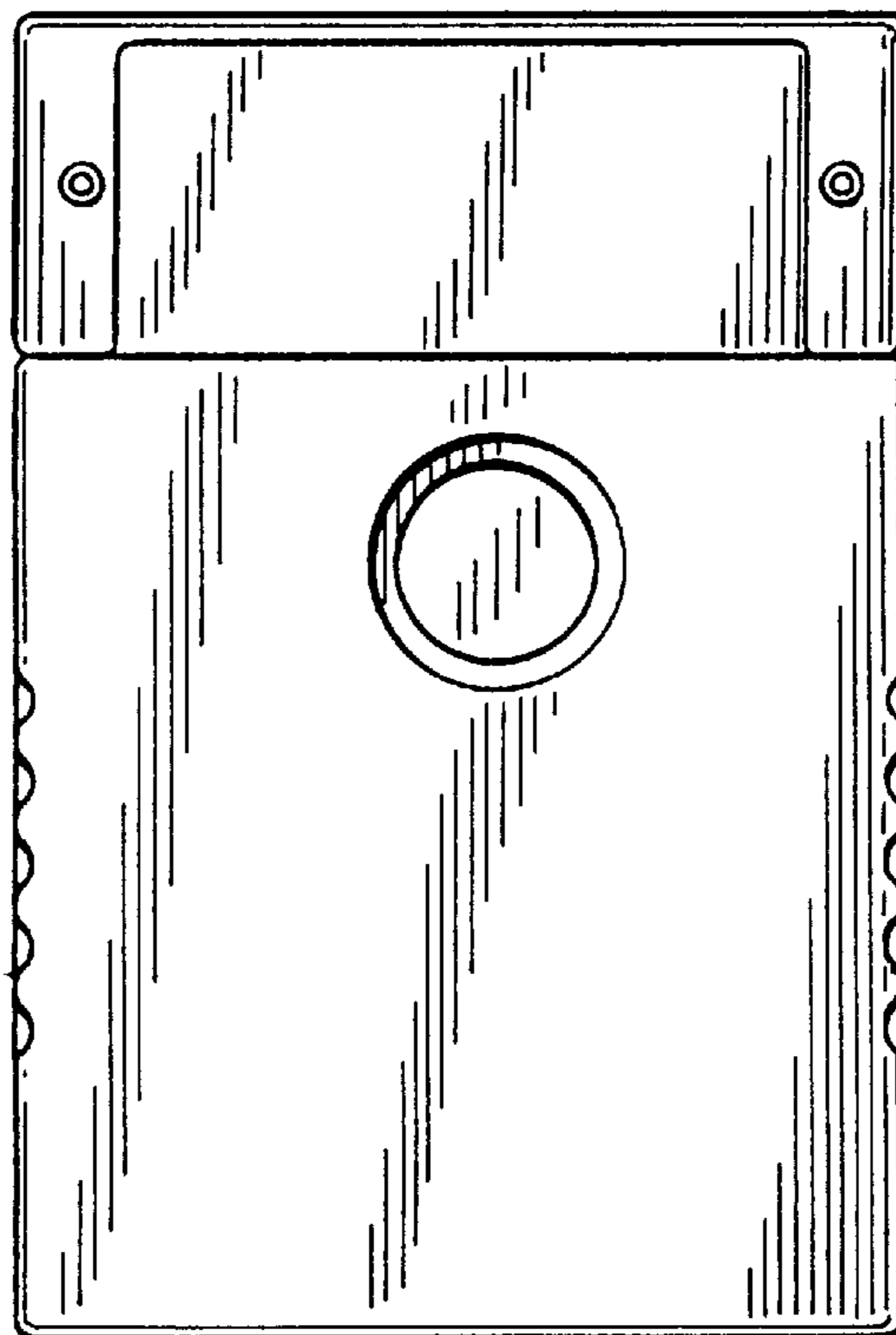

FIG. 9

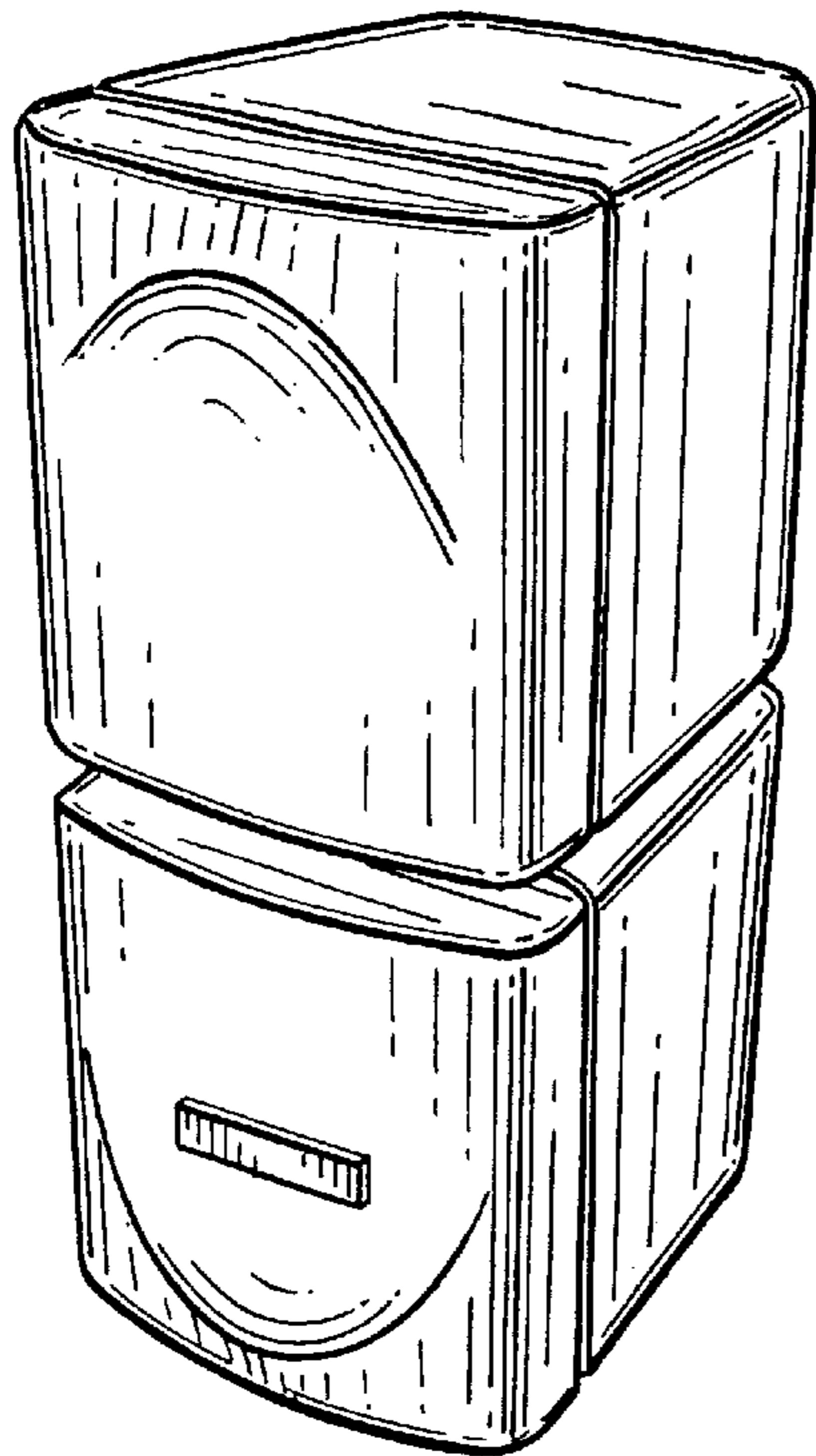

FIG. 10

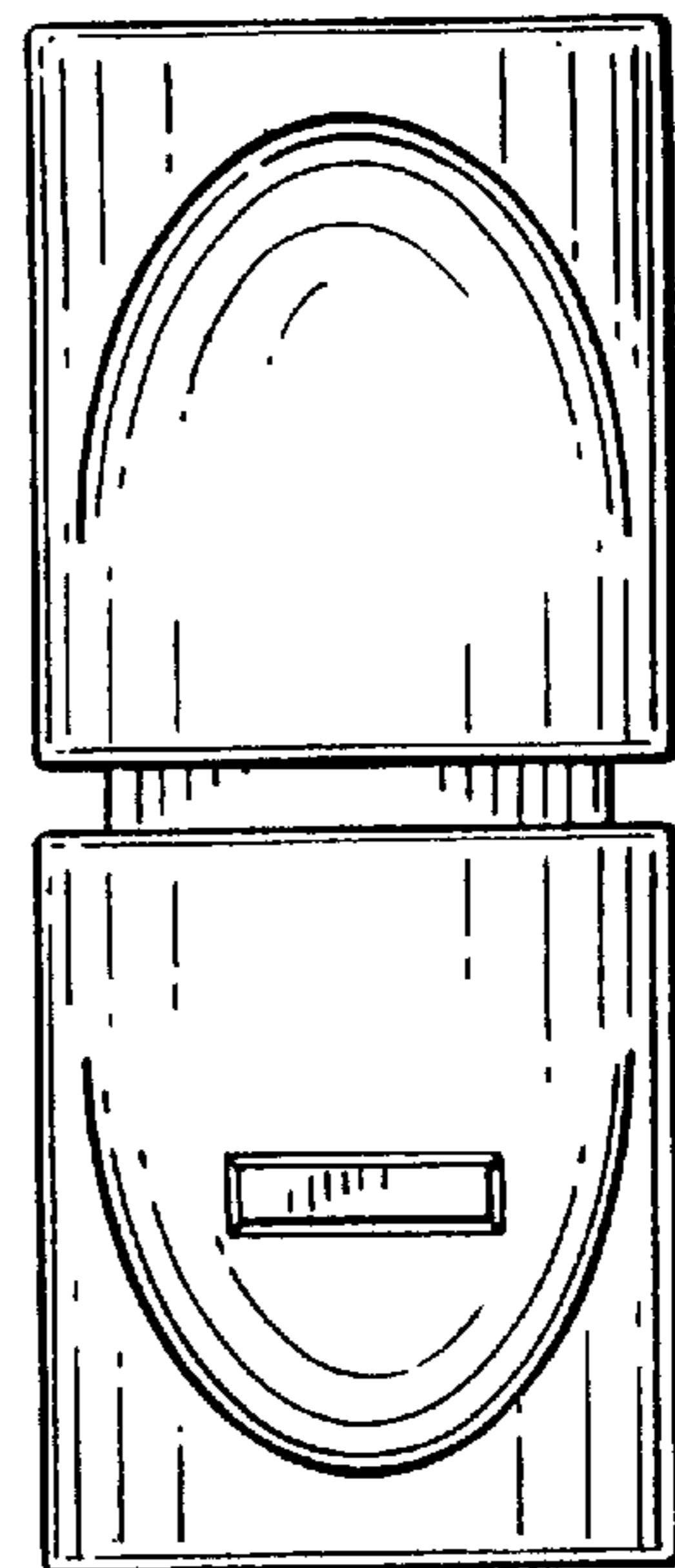

FIG. 11

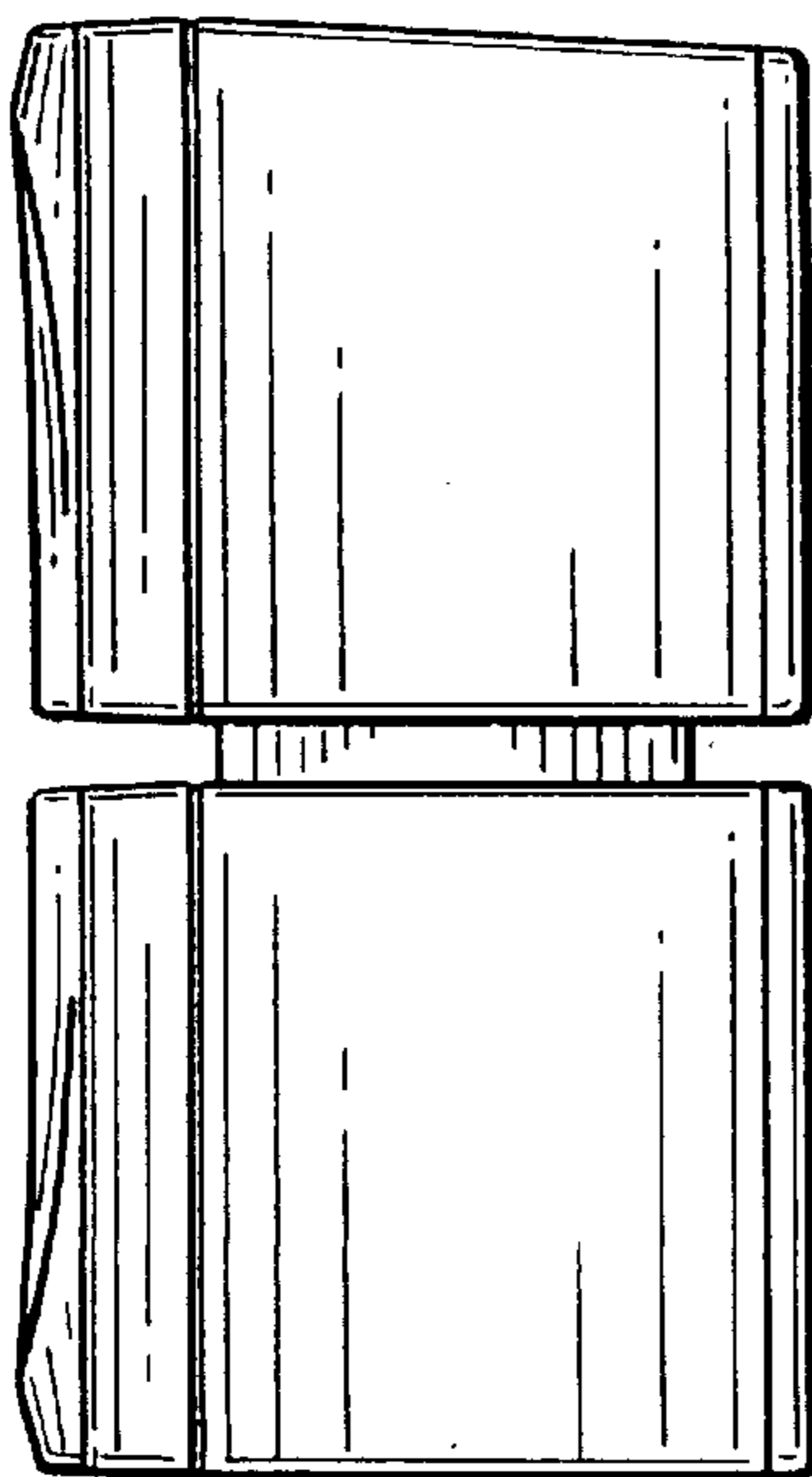

FIG. 12

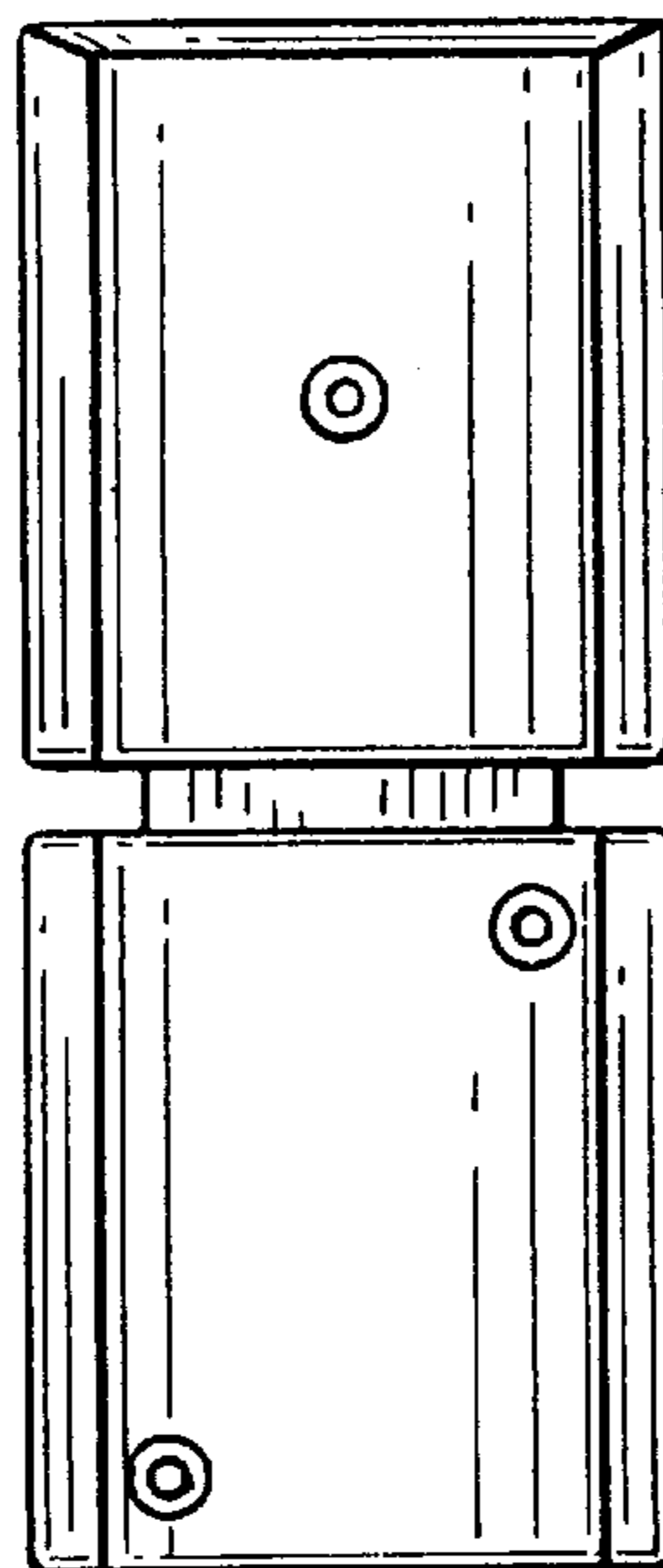

FIG. 13

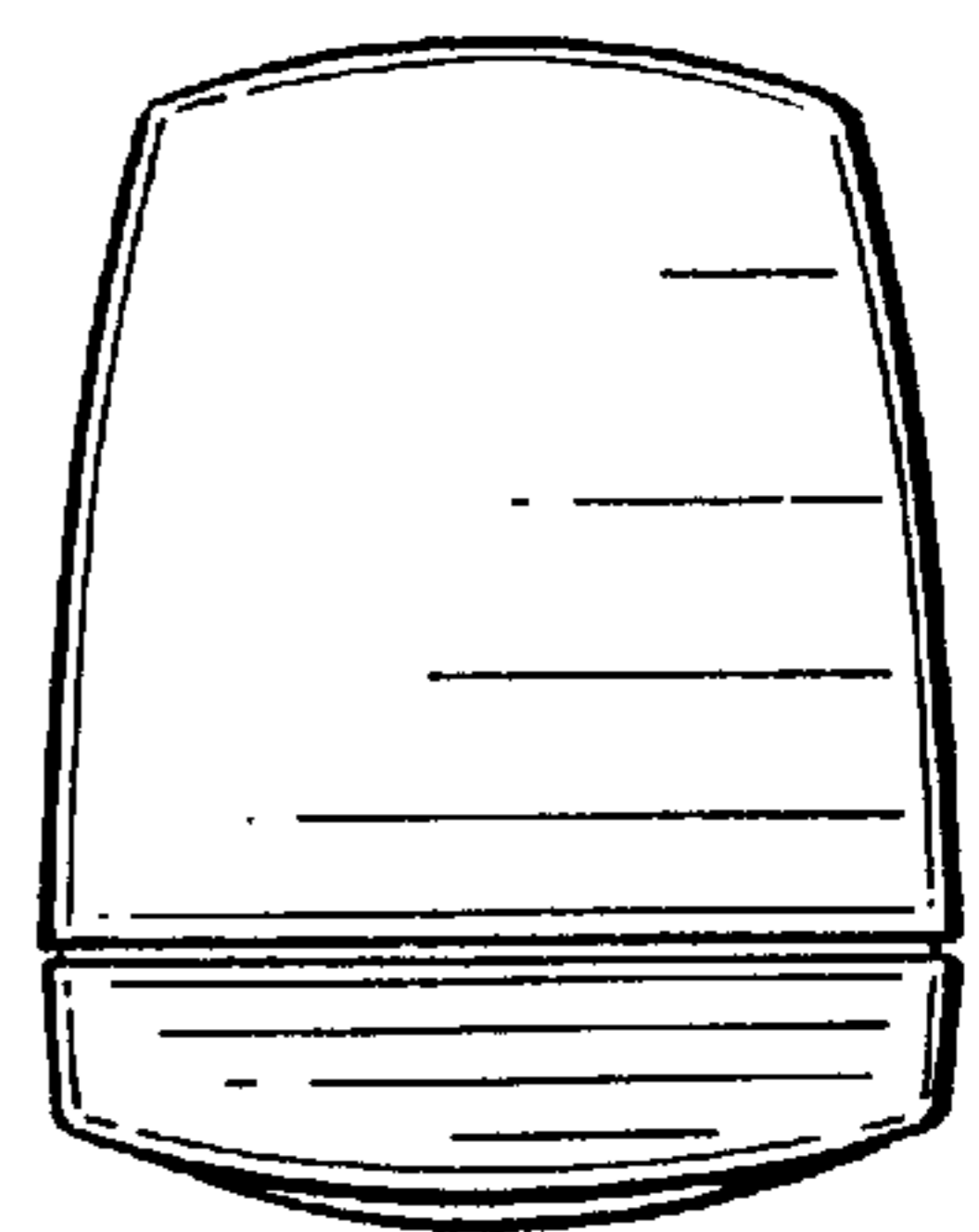

FIG. 14