



US00D429229S

# United States Patent [19] Fitzgerald

[11] **Patent Number: Des. 429,229**

[45] **Date of Patent: \*\* Aug. 8, 2000**

[54] **CORDLESS TELEPHONE HEADSET**

[76] Inventor: **Robert M. Fitzgerald**, 2290 S. Parker Rd., Suite 150, Denver, Colo. 80231

[\*\*] Term: **14 Years**

[21] Appl. No.: **29/090,921**

[22] Filed: **Jul. 20, 1998**

### Related U.S. Application Data

[63] Continuation-in-part of application No. 29/090,328, Jul. 6, 1998, which is a continuation-in-part of application No. 29/089,569, Jun. 18, 1998.

[51] **LOC (7) Cl. .... 14-03**

[52] **U.S. Cl. .... D14/142; D14/206**

[58] **Field of Search** ..... D14/137, 138, D14/147-148, 247-248, 250, 240, 140, 142, 205, 206, 223; 379/430, 433, 434, 419, 420, 428, 440; 455/550-575, 90; 381/375-378; 181/128, 137

### [56] **References Cited**

#### U.S. PATENT DOCUMENTS

- D. 305,759 1/1990 Balbuena .
- D. 327,265 6/1992 Jasey .
- D. 337,116 7/1993 Hattori .
- D. 342,947 1/1994 Totsuka ..... D14/205
- D. 344,730 3/1994 Gattey et al. .... D14/206
- D. 364,617 11/1995 Fitzgerald .
- D. 394,058 5/1998 Fitzgerald .
- D. 394,436 5/1998 Hall et al. .... D14/206
- 4,484,029 11/1984 Kenney ..... 455/568
- 4,882,745 11/1989 Silver .

- 5,003,589 3/1991 Chen ..... 379/433
- 5,086,464 2/1992 Groppe .
- 5,117,464 5/1992 Jones et al. .
- 5,469,505 11/1995 Gattey et al. .
- 5,528,689 6/1996 Chan .

### OTHER PUBLICATIONS

Hello Direct, Winter 1991, p. 6, Cordless Headset.

*Primary Examiner*—Jeffrey Asch  
*Attorney, Agent, or Firm*—Davis, Graham & Stubbs, LLP

### [57] **CLAIM**

The ornamental design for a cordless telephone headset, as shown and described.

### DESCRIPTION

FIG. 1 is a right side rear perspective view of a cordless telephone headset showing my new design; FIG. 2 is a rear elevation view; FIG. 3 is a right side elevation view; FIG. 4 is a left side elevation view; FIG. 5 is a front elevation view; FIG. 6 is a bottom plan view; FIG. 7 is a top plan view; and, FIG. 8 is a right side rear perspective view thereof showing, in phantom, a telephone base supporting said cordless telephone headset therein.

The broken line showing in FIG. 8 is for illustrative purposes only and forms no part of the claimed design. Portions of the broken line disclosure have been shown through the solid line disclosure for convenience of illustration. The headset of FIG. 8 being the same in appearance as that shown in FIG. 1.

**1 Claim, 4 Drawing Sheets**





FIG. 1

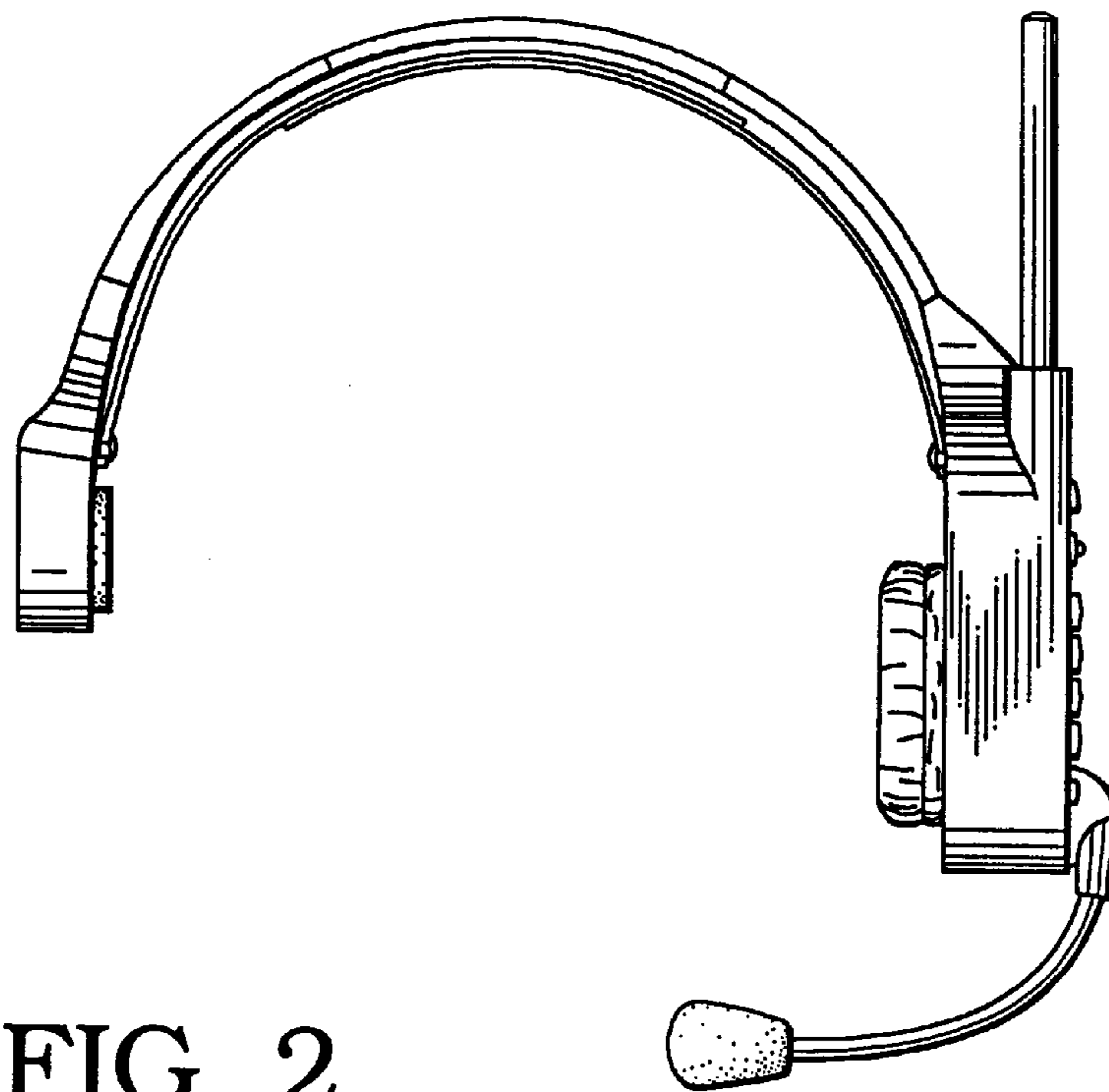

FIG. 2

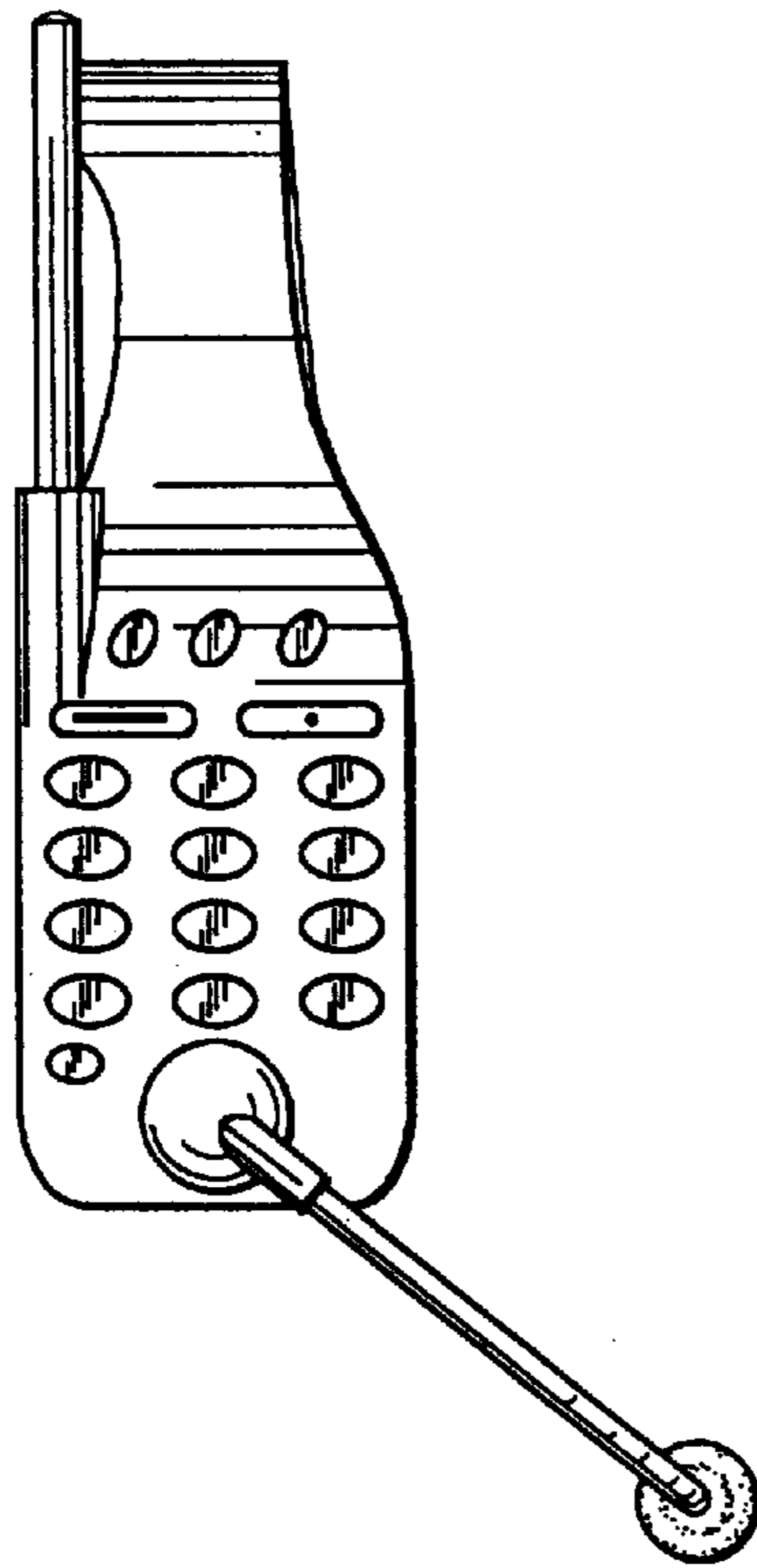

FIG. 3

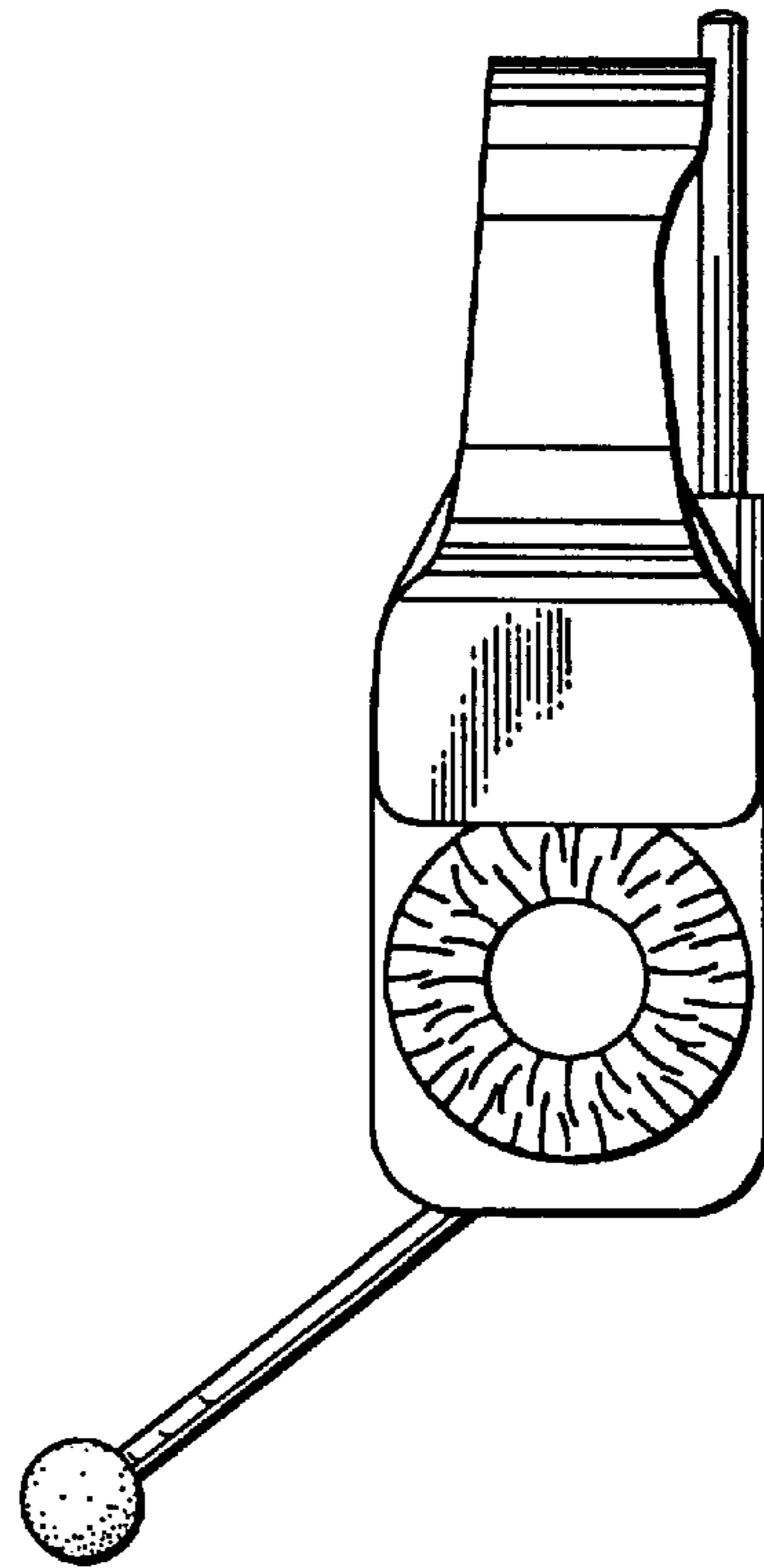

FIG. 4

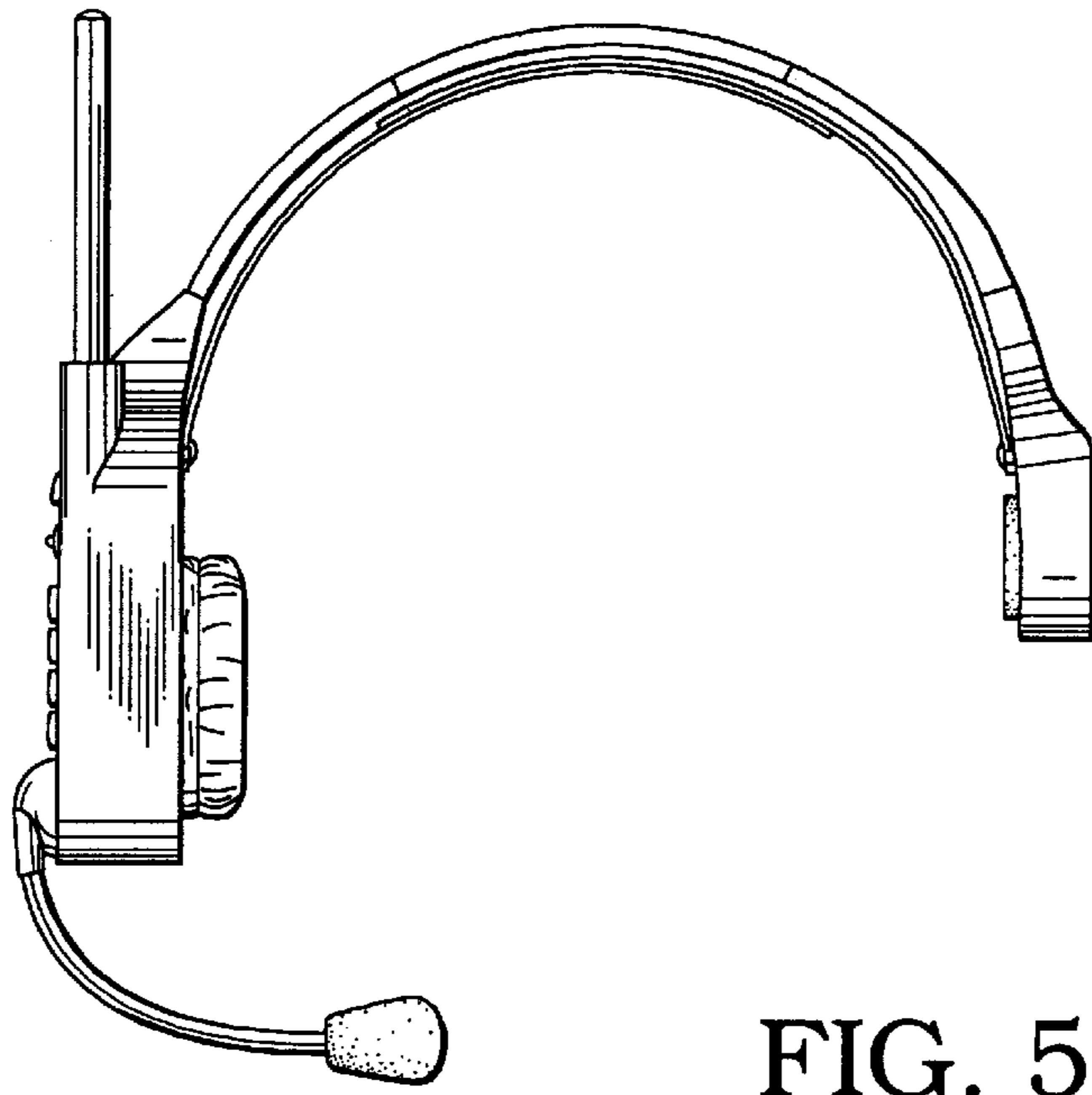

FIG. 5

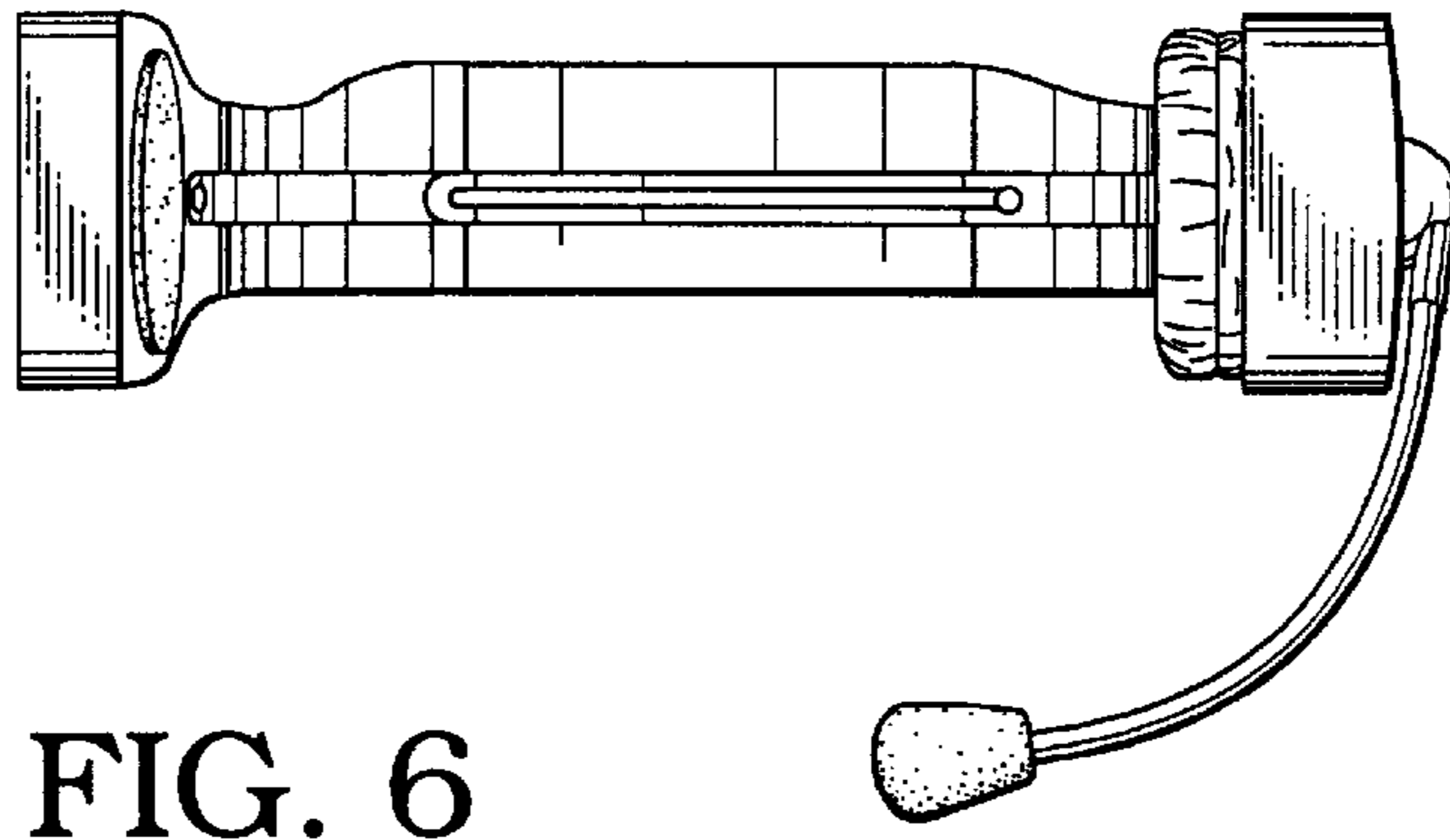

FIG. 6

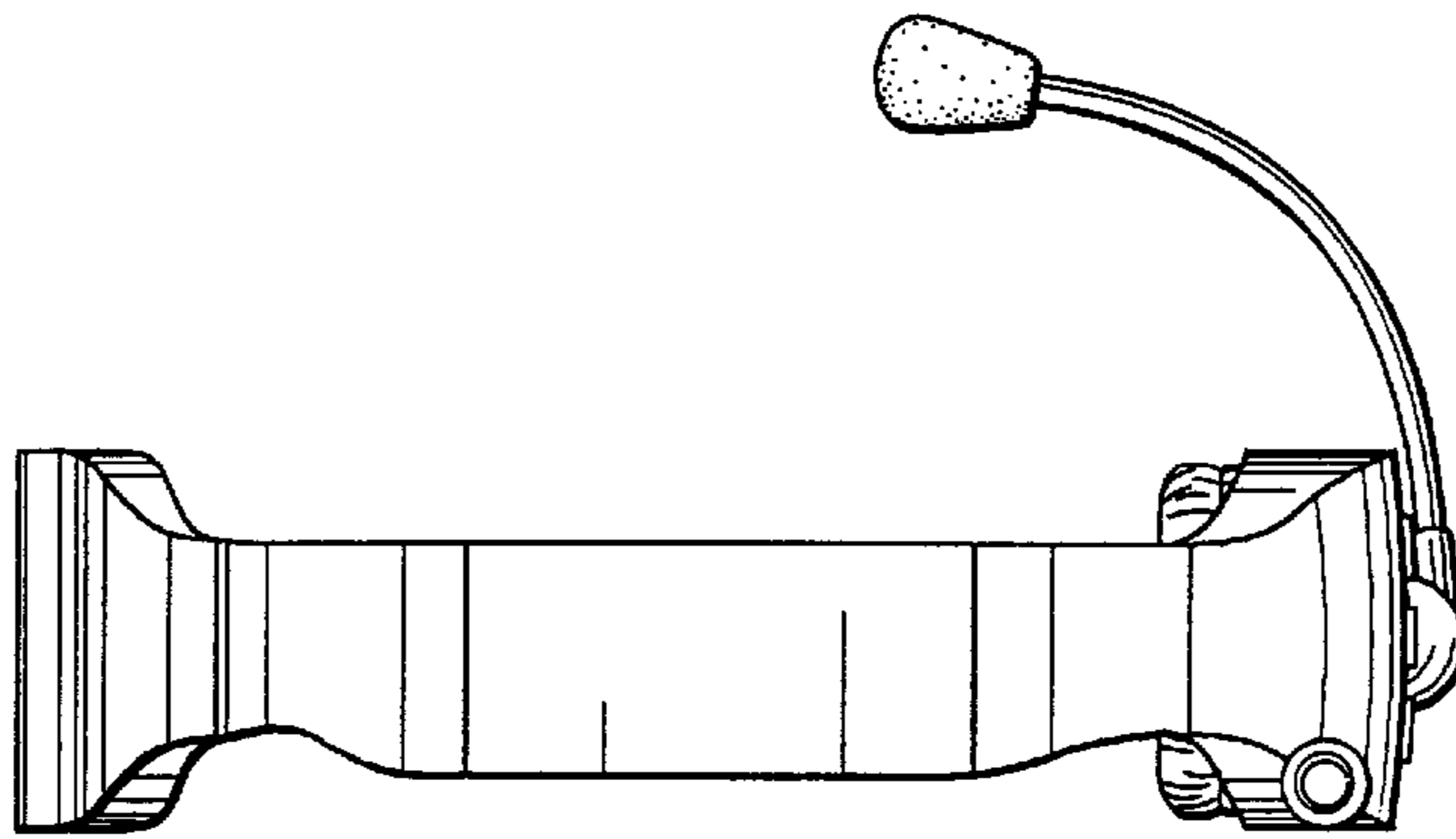

FIG. 7

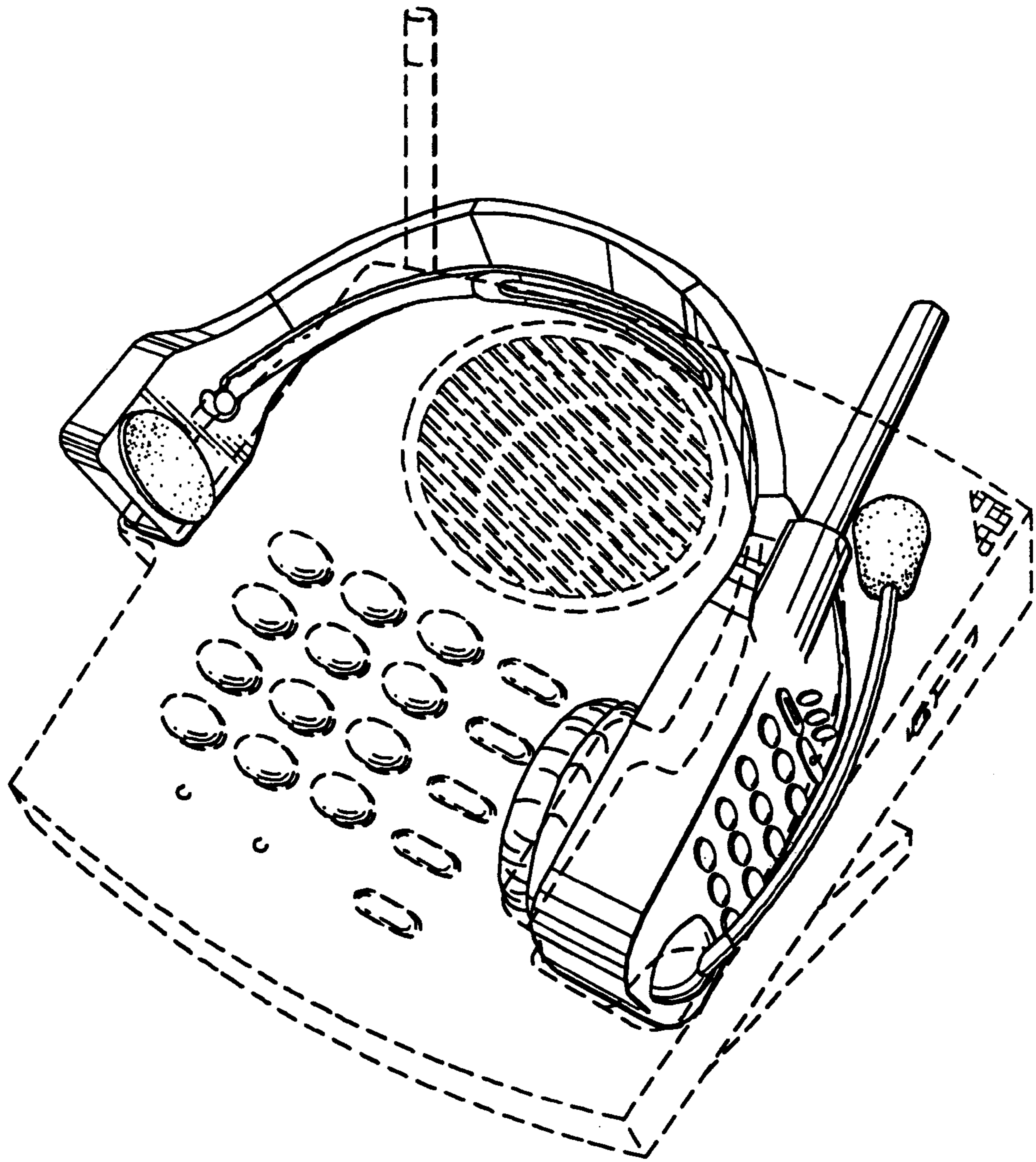

FIG. 8