



US00D429108S

# United States Patent [19] Smith

[11] **Patent Number: Des. 429,108**

[45] **Date of Patent: \*\* Aug. 8, 2000**

[54] **BEVERAGE DISPENSER**

[75] Inventor: **Andrew Smith**, Bishop Auckland,  
United Kingdom

[73] Assignee: **Ebac Limited**, United Kingdom

[\*\*] Term: **14 Years**

[21] Appl. No.: **29/109,844**

[22] Filed: **Aug. 23, 1999**

[30] **Foreign Application Priority Data**

Feb. 26, 1999 [GB] United Kingdom ..... 2081495

[51] **LOC (7) Cl.** ..... **07-01**

[52] **U.S. Cl.** ..... **D7/306; D7/300**

[58] **Field of Search** ..... D7/300, 306, 305,  
D7/307, 308; 221/150 R, 189; 222/185.1,  
391, 150 R; 99/305

[56] **References Cited**

**U.S. PATENT DOCUMENTS**

D. 322,534 12/1991 Chaney ..... D7/306

D. 350,453 9/1994 Chaney ..... D7/306  
D. 359,649 6/1995 Salkeld et al. .... D7/307  
D. 366,803 2/1996 Hauser, II et al. .... D7/307

*Primary Examiner*—M. N. Pandozzi  
*Attorney, Agent, or Firm*—Ira S. Dorman

[57] **CLAIM**

The ornamental design for a beverage dispenser, as shown.

**DESCRIPTION**

FIG. 1 is a side elevational view of the beverage dispenser embodying the present invention;

FIG. 2 is an opposite side elevational view of the dispenser;

FIG. 3 is a front elevational view of the dispenser;

FIG. 4 is a rear elevational view of the dispenser;

FIG. 5 is a top plan view of the dispenser;

FIG. 6 is a perspective view of the dispenser; and,

FIG. 7 is a bottom plan view of the dispenser.

**1 Claim, 4 Drawing Sheets**

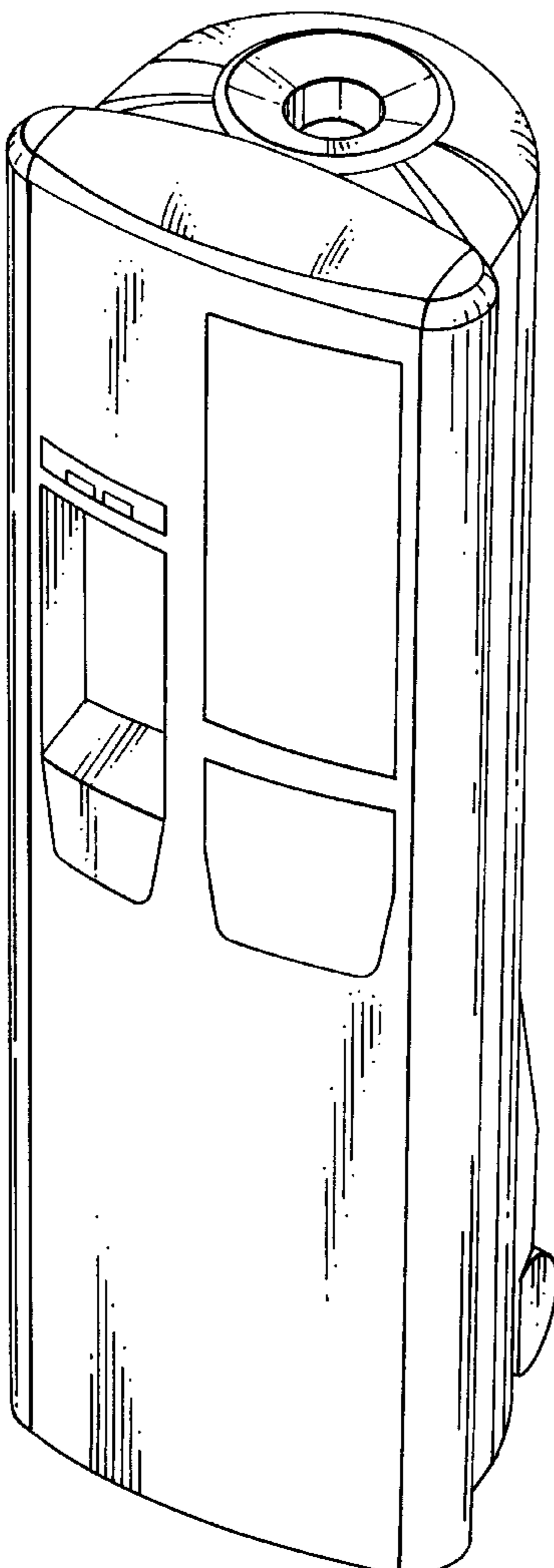

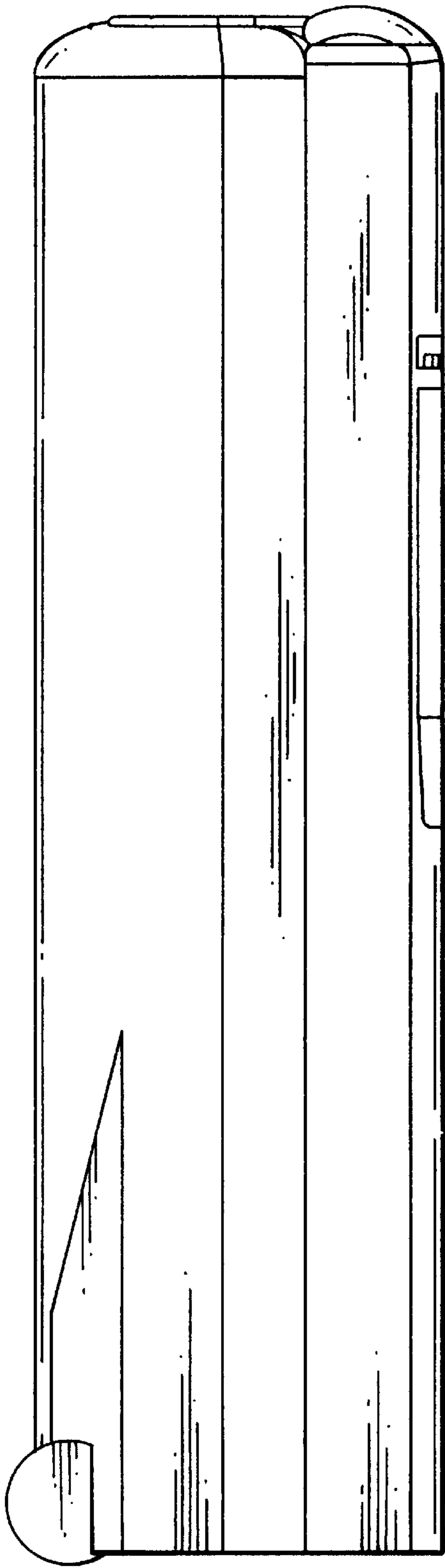

FIG. 1

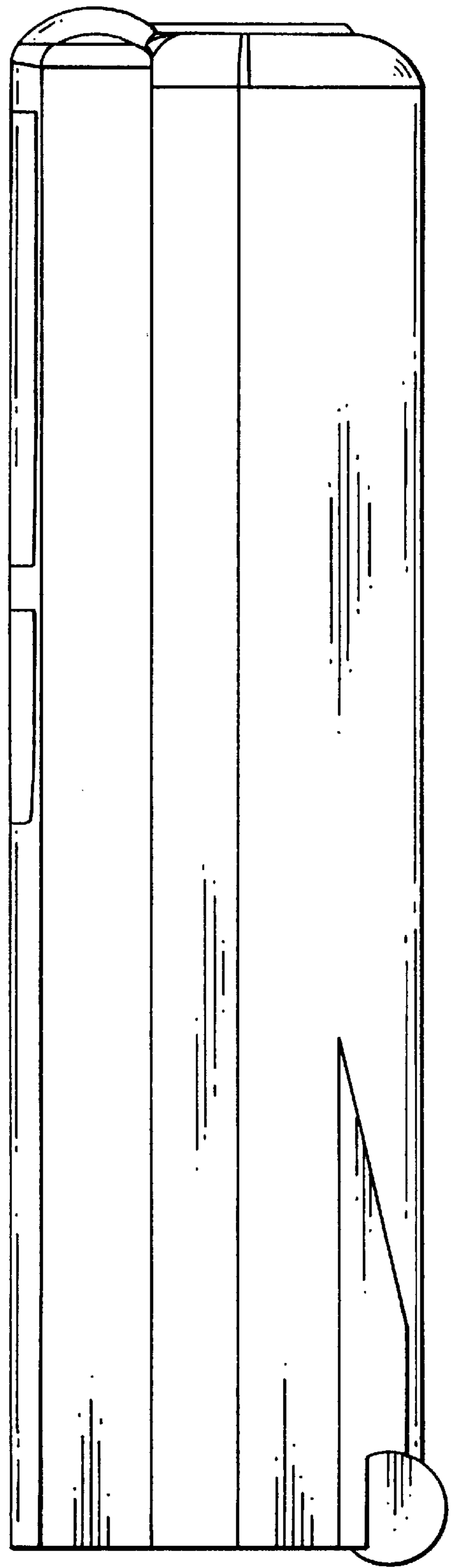

FIG. 2

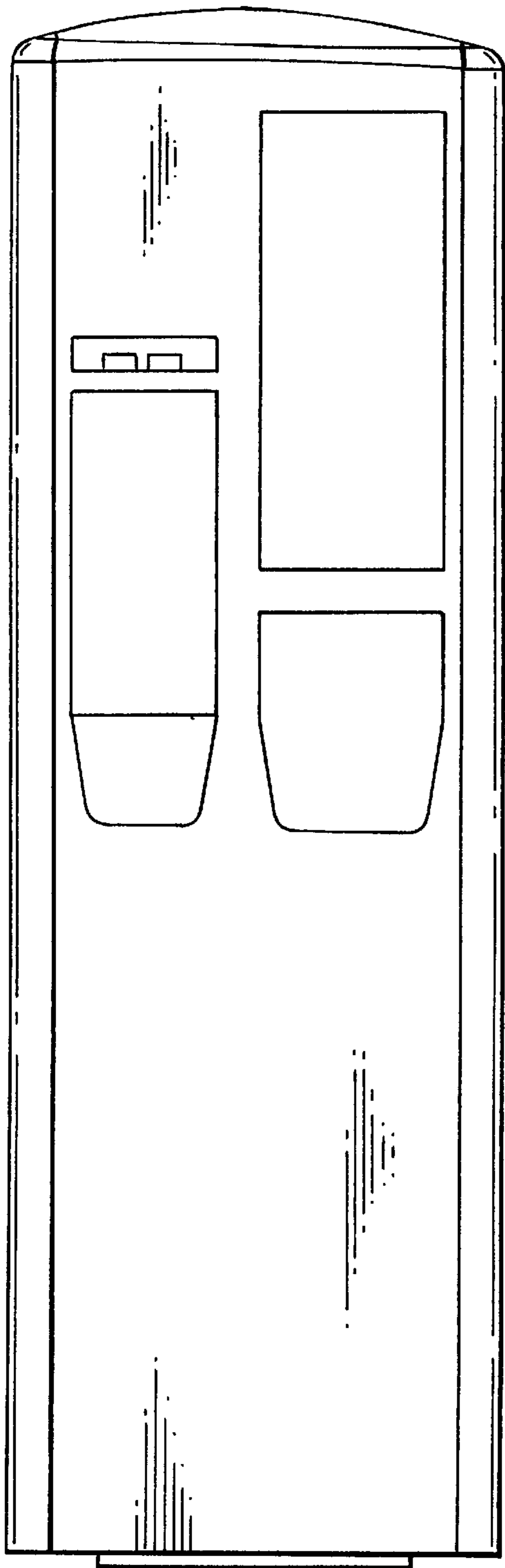

FIG. 3

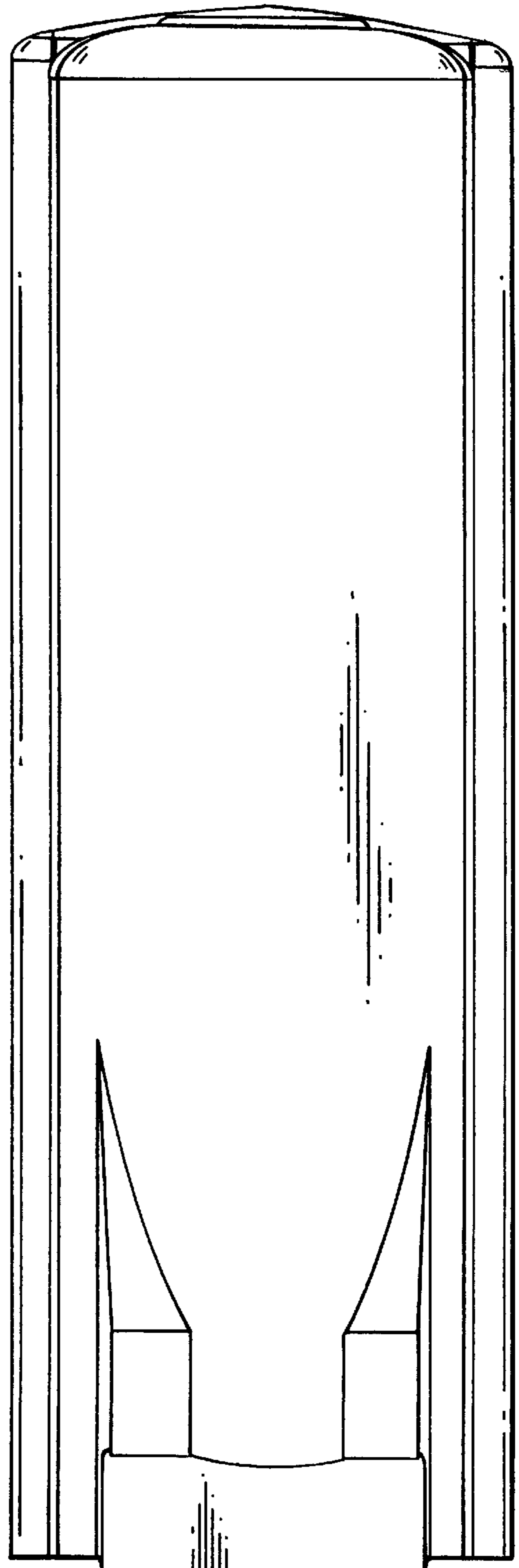
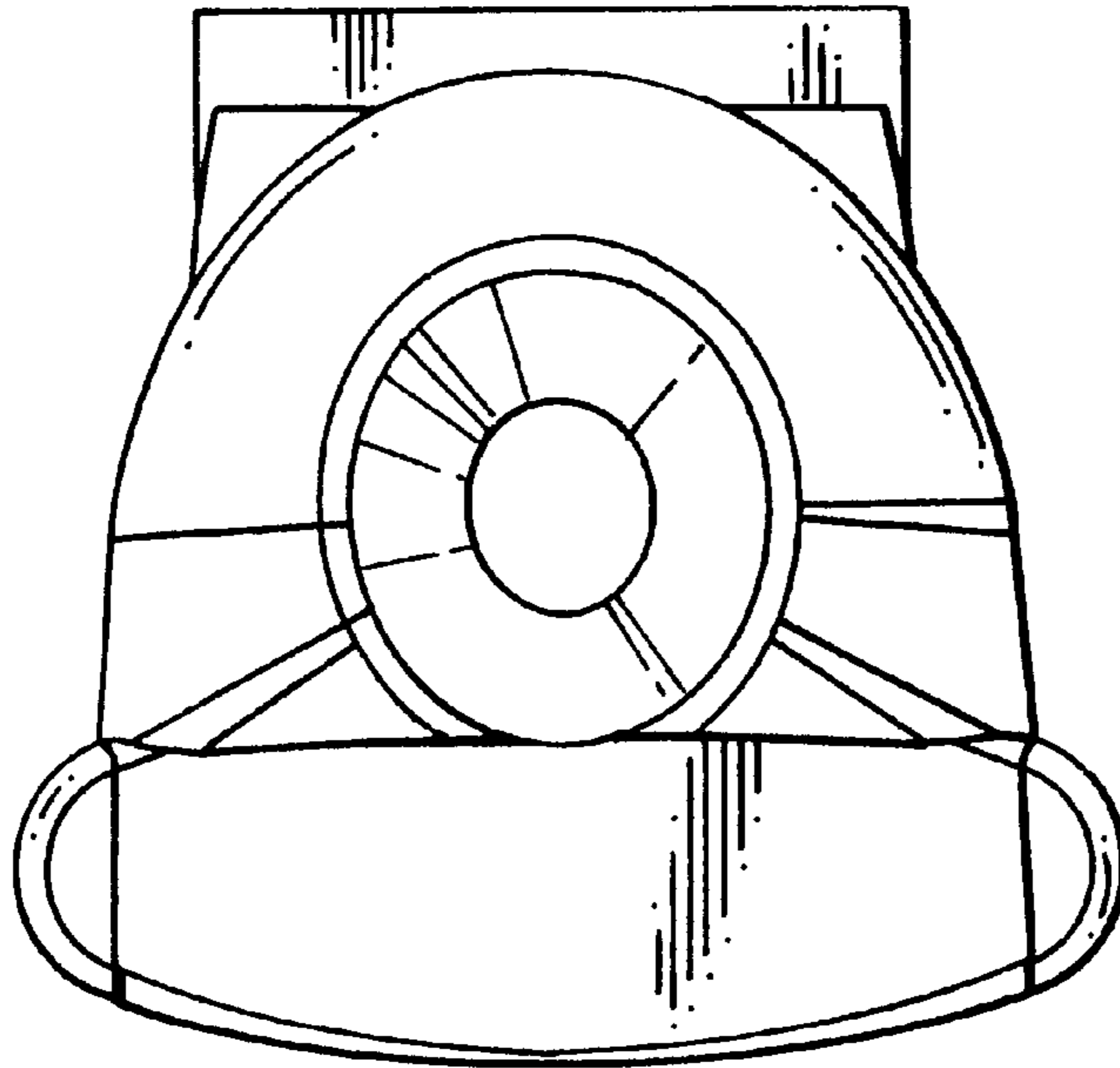
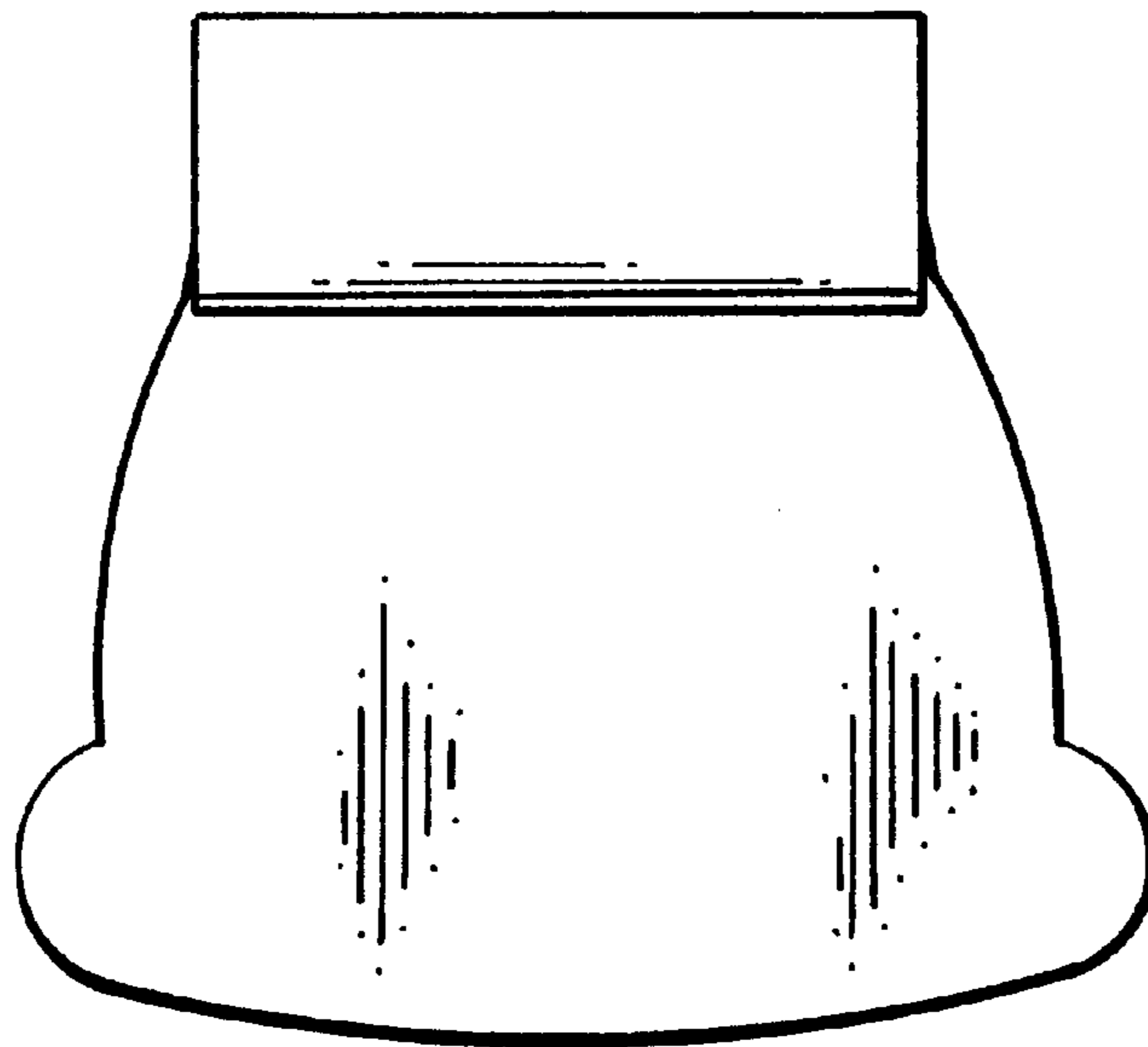

FIG. 4



*FIG. 5*



*FIG. 7*

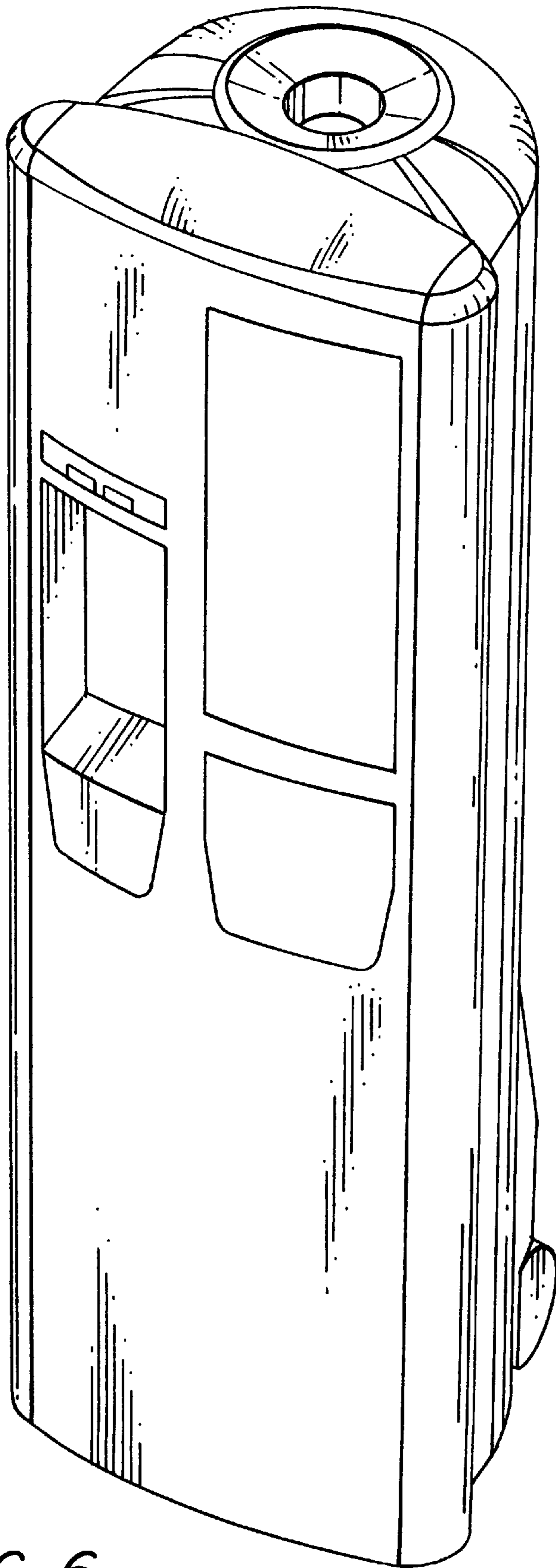

FIG. 6