



US00D429080S

# United States Patent [19]

[11] **Patent Number: Des. 429,080**

**Natuzzi et al.**

[45] **Date of Patent: \*\* Aug. 8, 2000**

[54] **SEAT**

[75] Inventors: **Pasquale Natuzzi, Bari; Suma Cosimo, Matera, both of Italy**

[73] Assignee: **Industrie Natuzzi Spa, Bari, Italy**

[\*\*] Term: **14 Years**

[21] Appl. No.: **29/103,479**

[22] Filed: **Apr. 15, 1999**

[51] **LOC (7) Cl. .... 06-01**

[52] **U.S. Cl. .... D6/381; D6/334**

[58] **Field of Search ..... D6/334, 335, 336, D6/364, 371, 373, 381, 500, 501, 502; 5/12.1; 297/232, 445.1, 446.1**

### [56] **References Cited**

#### **U.S. PATENT DOCUMENTS**

D. 362,353	9/1995	Natuzzi et al. ....	D6/381
D. 373,257	9/1996	Hutton .....	D6/381
D. 374,355	10/1996	Natuzzi et al. ....	D6/381
D. 381,218	7/1997	Gera .....	D6/381
D. 382,130	8/1997	Natuzzi et al. ....	D6/381
D. 387,575	12/1997	Natuzzi et al. ....	D6/381
D. 391,092	2/1998	Natuzzi et al. ....	D6/381
D. 400,368	11/1998	Natuzzi et al. ....	D6/381
D. 407,572	4/1999	Natuzzi et al. ....	D6/381
D. 407,573	4/1999	Natuzzi et al. ....	D6/381
D. 415,904	11/1999	Zaidman .....	D6/381

#### **OTHER PUBLICATIONS**

Natuzzi Model 1608, Apr. 1997, at International Home Furnishings Market in High Point, North Carolina.  
 Natuzzi Model 1616, Apr. 1997, at International Home Furnishings Market in High Point, North Carolina.  
 Natuzzi Model 1580, Apr. 1997, at International Home Furnishings Market in High Point, North Carolina.

Natuzzi Model 462, Oct. 1988, at International Home Furnishings Market in High Point, North Carolina.  
 Natuzzi Model 492, Apr. 1989, at International Home Furnishings Market in High Point, North Carolina.  
 Natuzzi Model 600/601, Oct. 1987, at International Home Furnishings Market in High Point, North Carolina.  
 Natuzzi Model 612, at least as early as 1988, at International Home Furnishings Market in High Point, North Carolina.  
 Natuzzi Model 725, Oct. 1989, at International Home Furnishings Market in High Point, North Carolina.

(List continued on next page.)

*Primary Examiner*—Gary D. Watson  
*Attorney, Agent, or Firm*—Alston & Bird LLP

### [57] **CLAIM**

The ornamental design for a seat, as shown and described.

### **DESCRIPTION**

FIG. 1 is a front perspective view of a seat showing our new design in the form of a sofa;  
 FIG. 2 is a front elevational view thereof;  
 FIG. 3 is a top plan view thereof;  
 FIG. 4 is a right side elevational view, the left side being a mirror image thereof;  
 FIG. 5 is a rear perspective view thereof;  
 FIG. 6 is a front elevational view of a seat showing our new design in the form of a loveseat; and,  
 FIG. 7 is a front elevational view of a seat showing our new design in the form of a chair.  
 The broken lines shown herein are for illustrative purposes only and form no part of the claimed design.  
 The rear views of FIGS. 6 and 7 are like FIG. 5, the difference being a matter of length.  
 The end views of FIGS. 6 and 7 are like FIG. 4.  
 FIG. 1 is shown on an enlarged scale with respect to the other views.

**1 Claim, 3 Drawing Sheets**

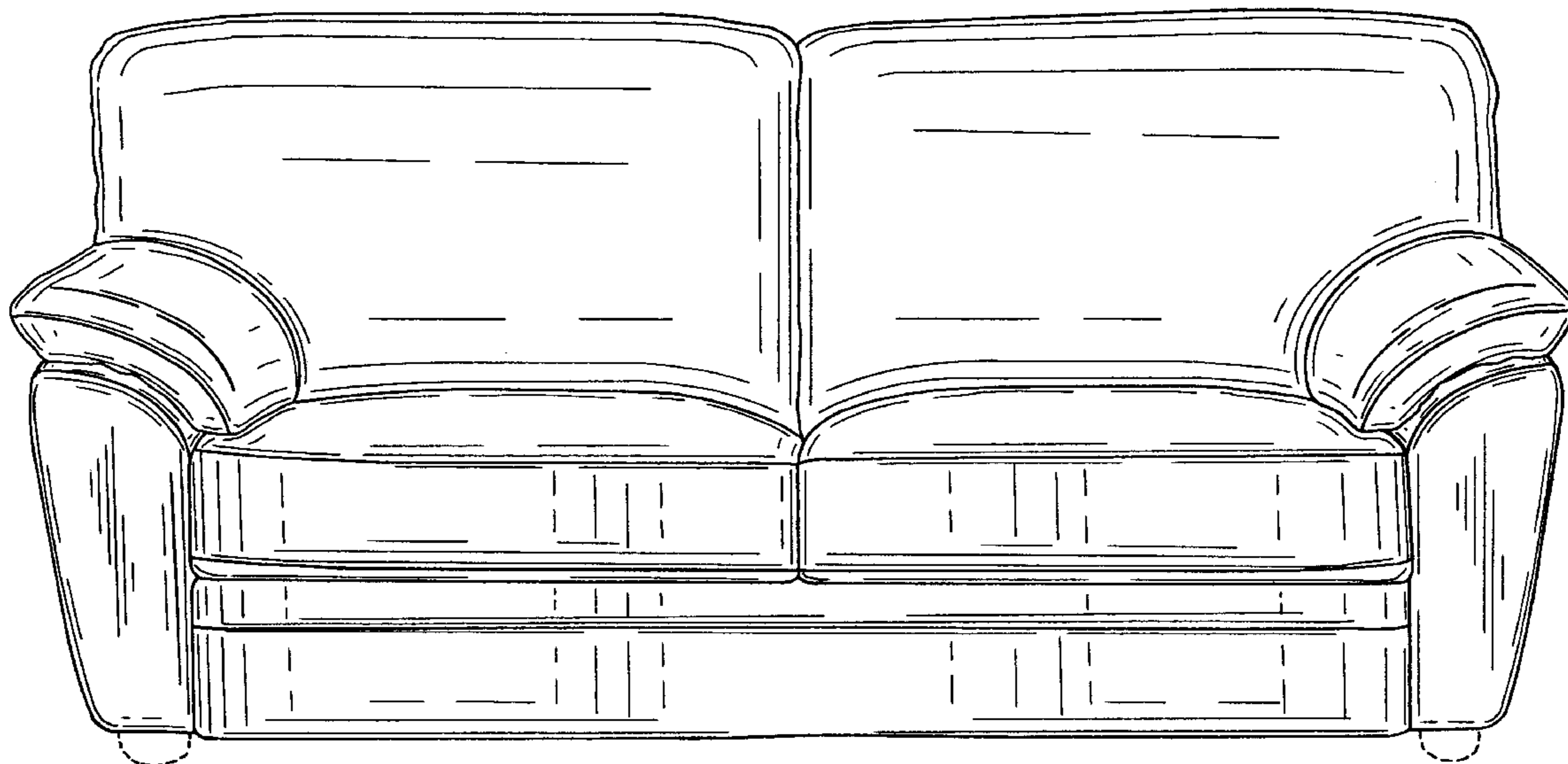

OTHER PUBLICATIONS

Natuzzi Model 734, Apr. 1990, at International Home Furnishings Market in High Point, North Carolina.

Natuzzi Model 738, Apr. 1990, at International Home Furnishings Market in High Point, North Carolina.

Natuzzi Model 779, Oct. 1990, at International Home Furnishings Market in High Point, North Carolina.

Natuzzi Model 798, Oct. 1990, at International Home Furnishings in High Point, North Carolina.

Natuzzi Model 898, Apr. 1992, at International Home Furnishings Market in High Point, North Carolina.

Natuzzi Model 907, Apr. 1992, at International Home Furnishings Market in High Point, North Carolina.

Natuzzi Model 941, Sep. 1992, at International Home Furnishings Market in High Point, North Carolina.

Natuzzi Model 1157, Apr. 1994, at International Home Furnishings Market in High Point, North Carolina.

Natuzzi Model 1334, Sep. 1995, at International Home Furnishings Market in High Point, North Carolina.

Natuzzi Model 1342, Oct. 1995, at International Home Furnishings Market in High Point, North Carolina.

Natuzzi Model 1369, Sep. 1995, at International Home Furnishings Market in High Point, North Carolina.

Natuzzi Model 1371, Oct. 1995, at International Home Furnishings Market in High Point, North Carolina.

Natuzzi Model 1462, Apr. 1996, at International Home Furnishings Market in High Point, North Carolina.

Natuzzi Model 1496, at least as early as 1996, at International Home Furnishings Market in High Point, North Carolina.

Natuzzi Model 1502, Oct. 1996, at International Home Furnishings Market in High Point, North Carolina.

Natuzzi Model 1584, Apr. 1997, at International Home Furnishings Market in High Point, North Carolina.

Natuzzi Model 1592, Apr. 1997, at International Home Furnishings Market in High Point, North Carolina.

Natuzzi Model 1634, Oct. 1997, at International Home Furnishings Market in High Point, North Carolina.

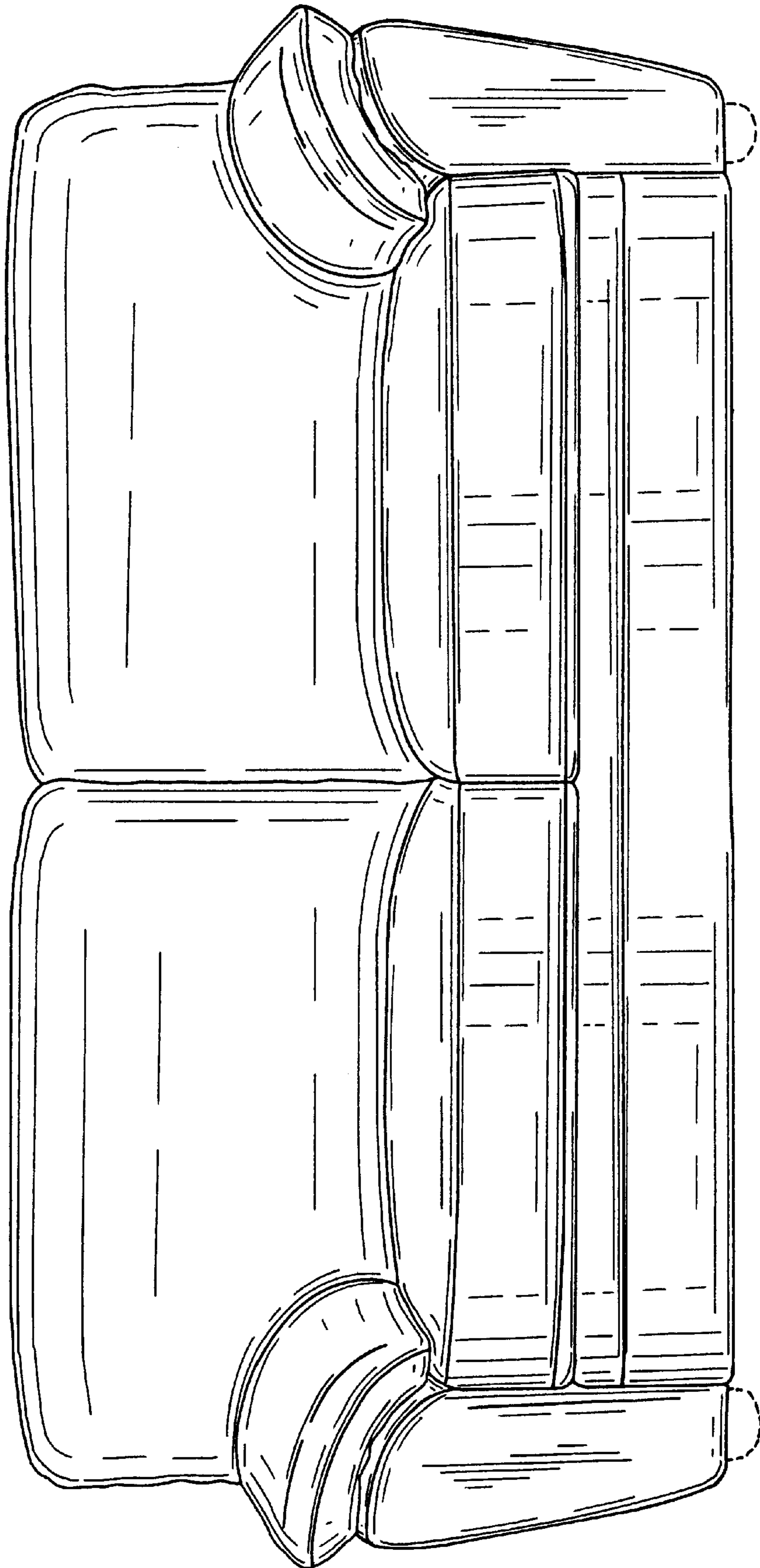

FIG. 1.

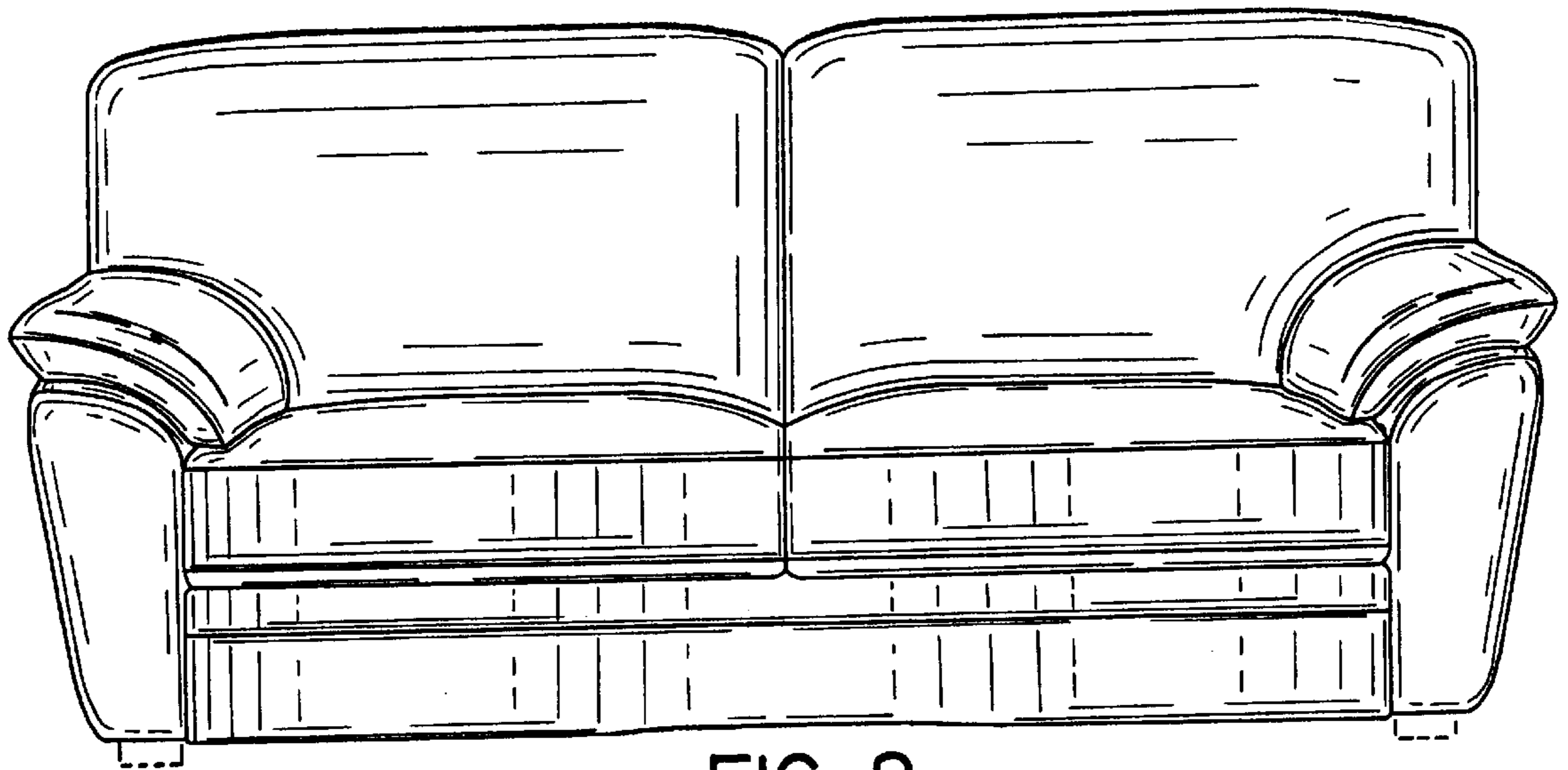

FIG. 2.

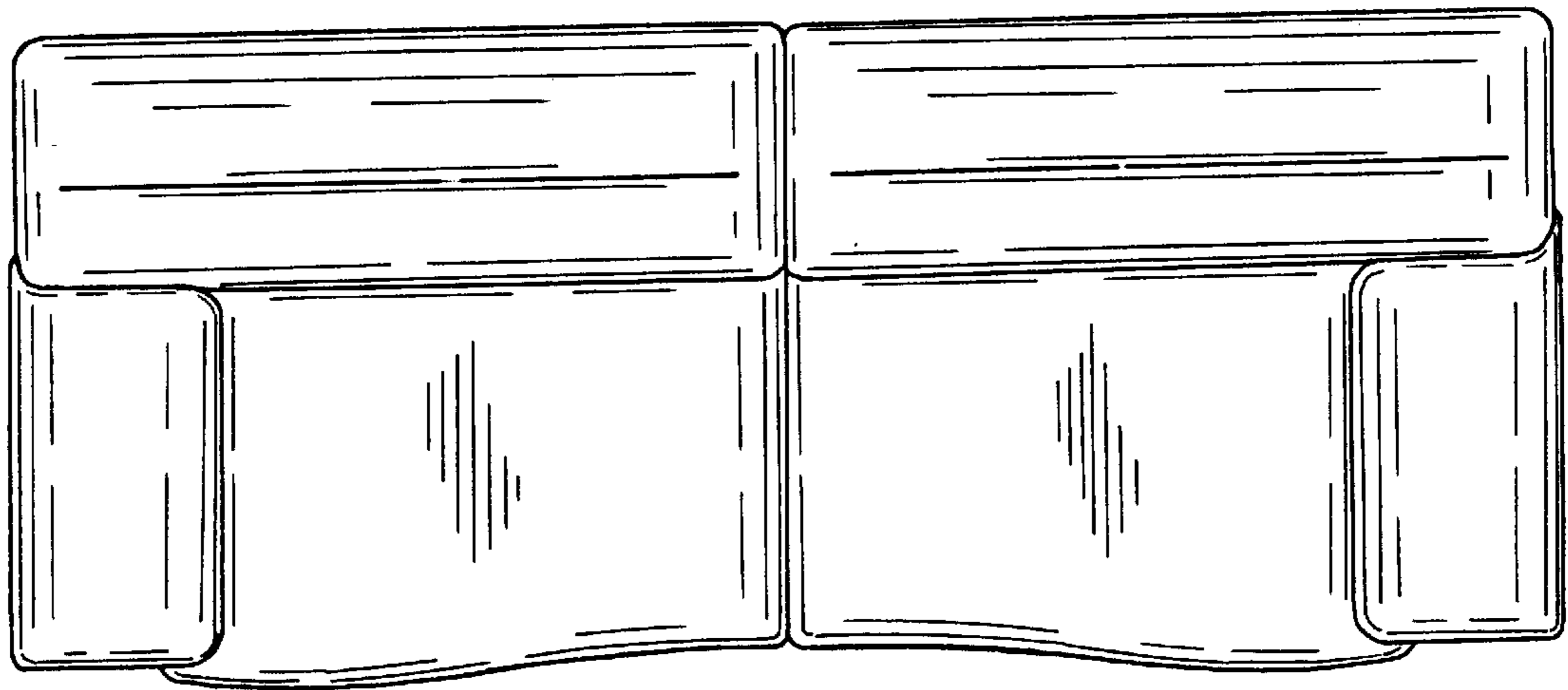

FIG. 3.

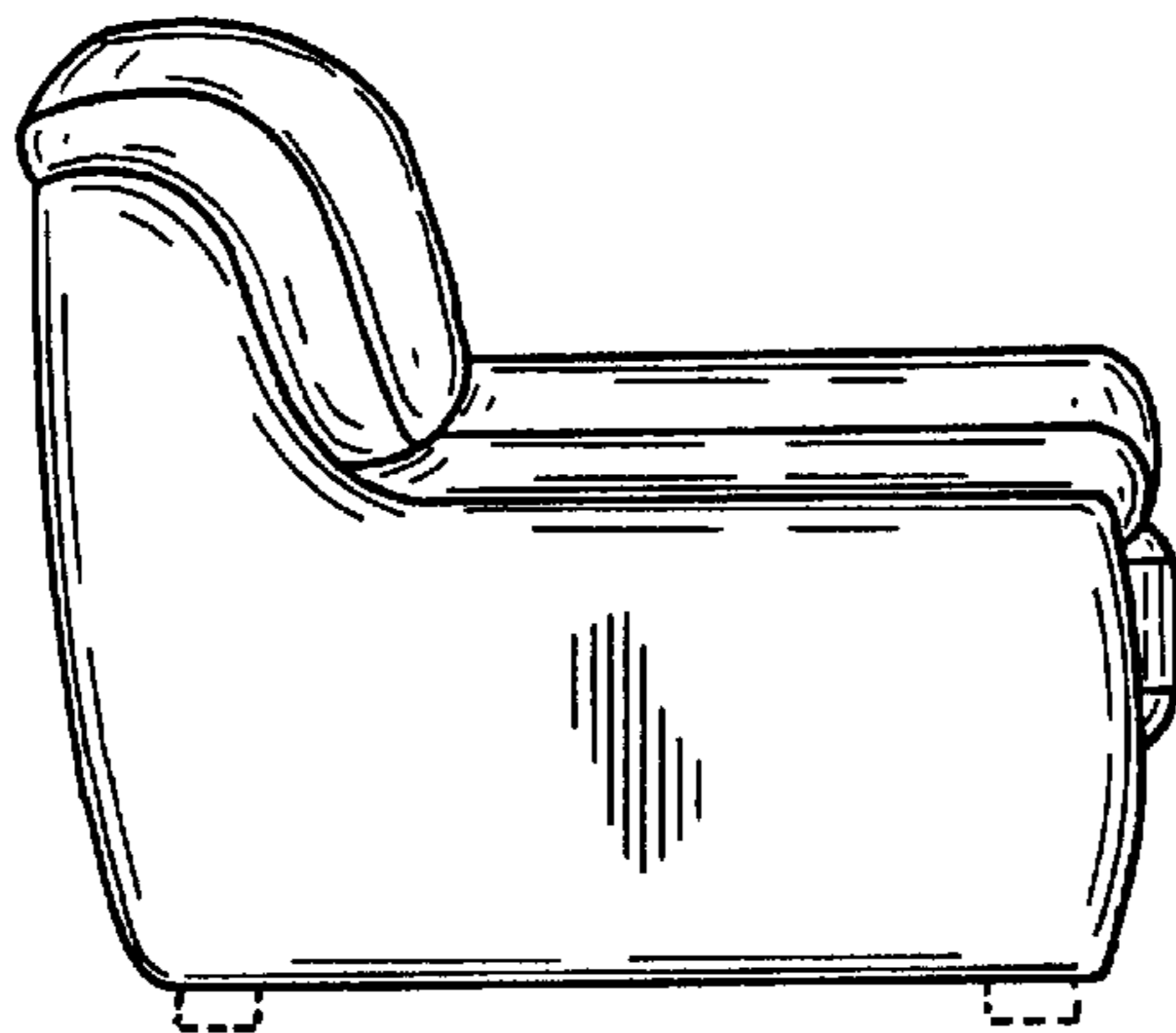

FIG. 4.

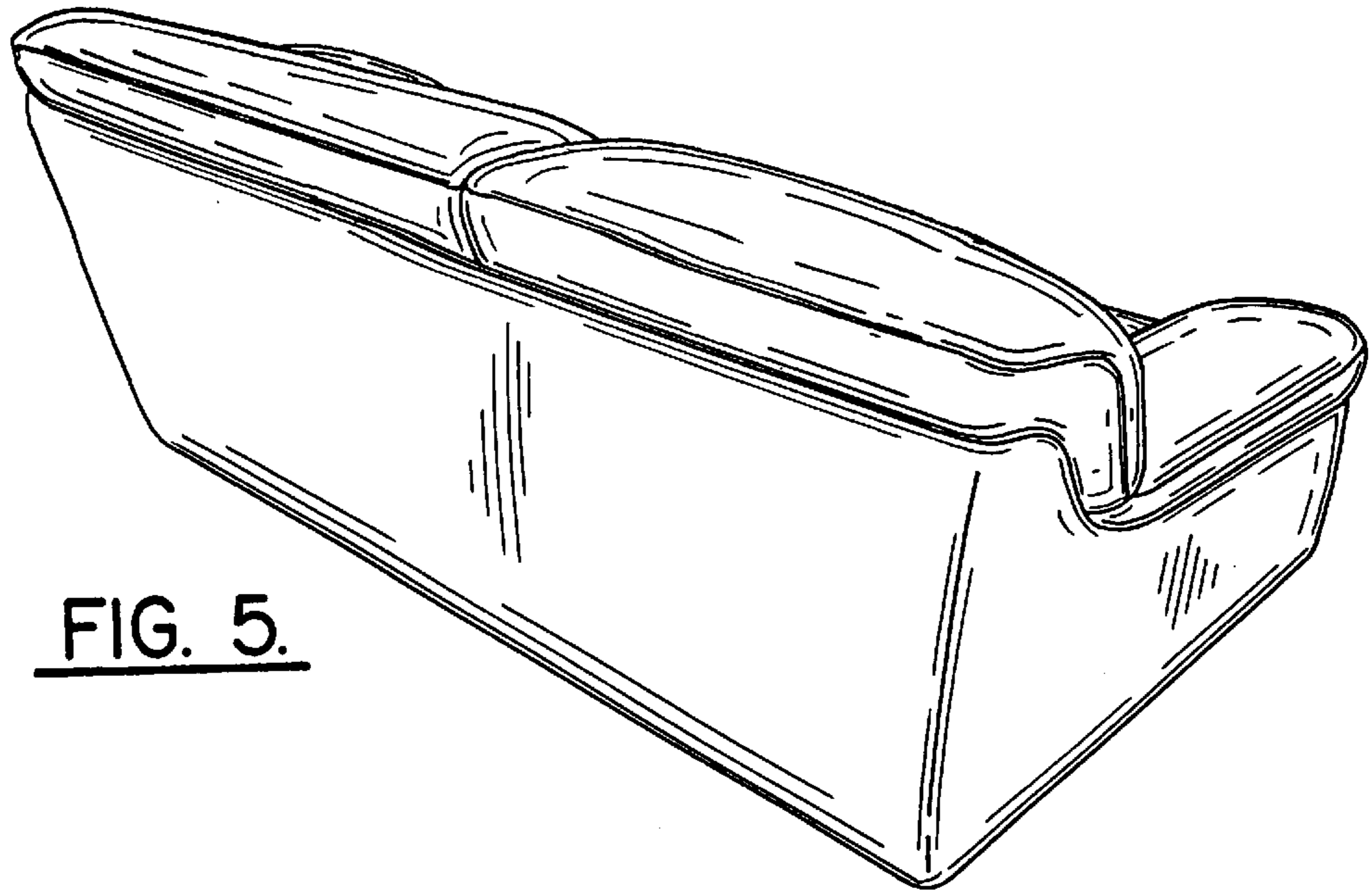

FIG. 5.

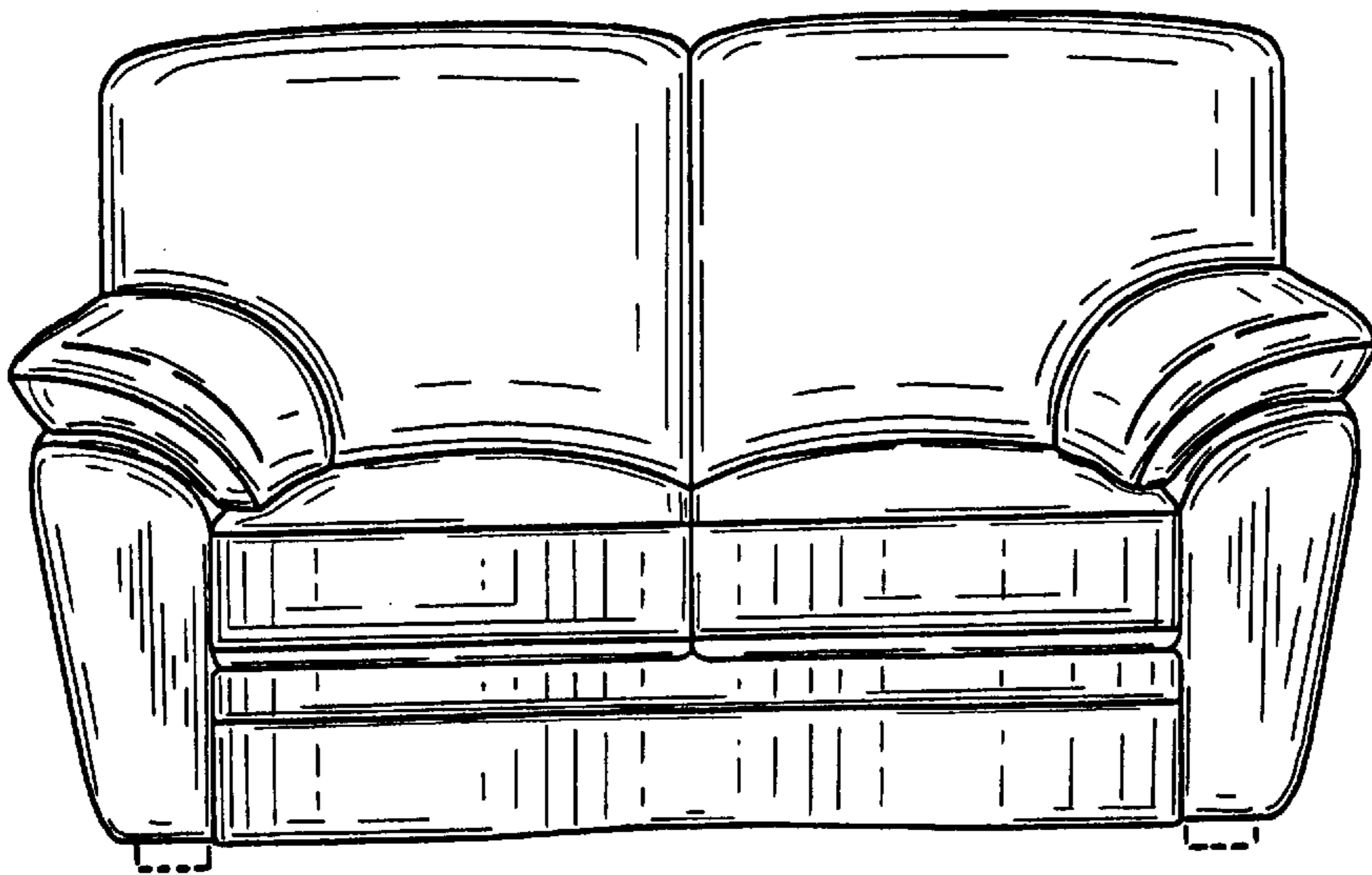

FIG. 6.

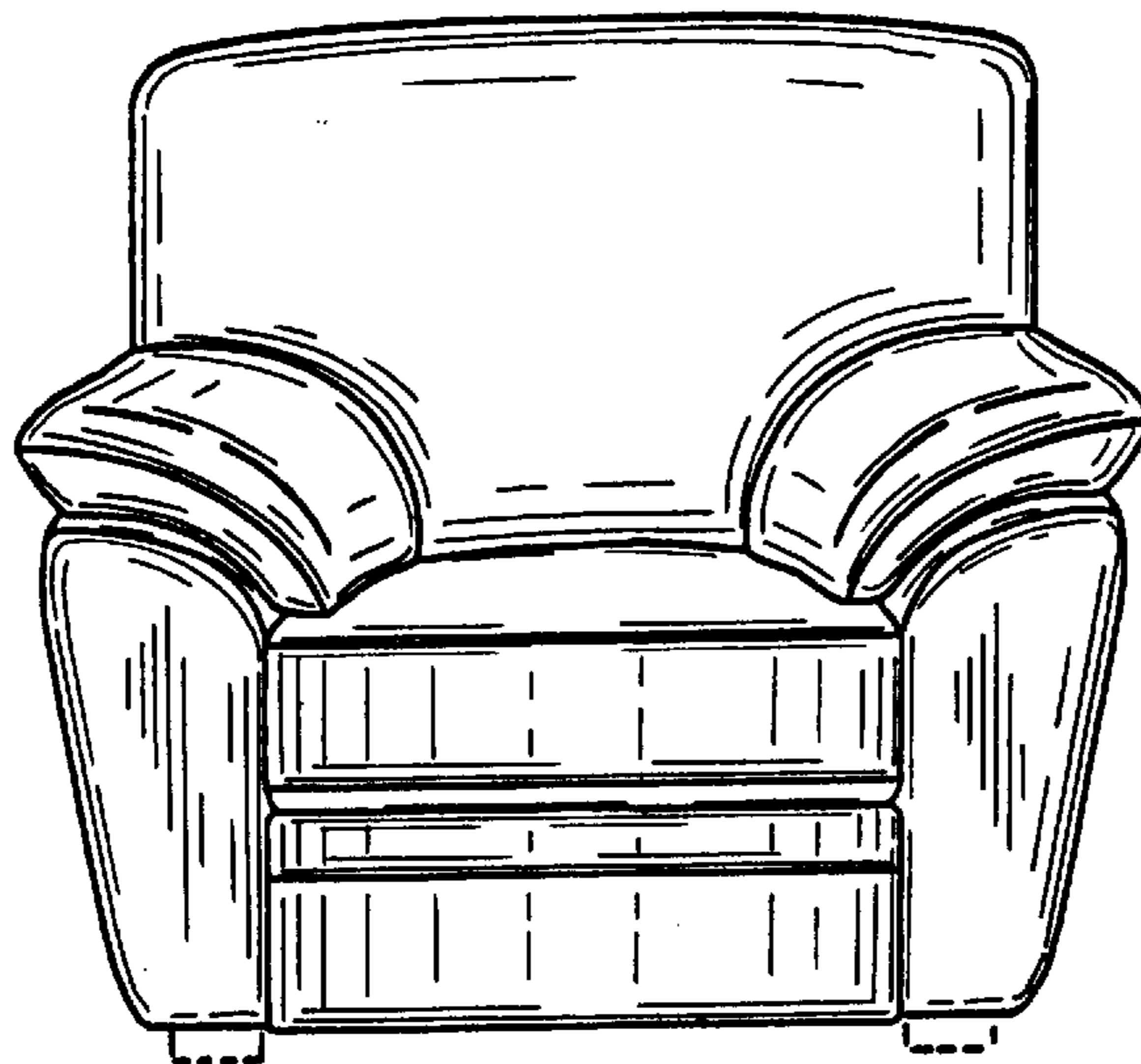

FIG. 7.