



US00D428866S

United States Patent [19]
You

[11] **Patent Number: Des. 428,866**

[45] **Date of Patent: ** Aug. 1, 2000**

[54] **HAND HELD TRANSCEIVER**

[75] Inventor: **Tai-San You, Hsin Tien, Taiwan**

[73] Assignee: **Sysgration Ltd., Taipei Hsien, Taiwan**

[**] Term: **14 Years**

[21] Appl. No.: **29/116,614**

[22] Filed: **Jan. 7, 2000**

[51] **LOC (7) Cl. 14-03**

[52] **U.S. Cl. D14/137**

[58] **Field of Search** D14/137, 138,
D14/140, 142, 218, 194, 159, 155, 188,
192, 198; D13/164, 168; 379/419, 420,
440, 433, 434; 455/347-349, 90, 575, 73,
128; D10/104, 106

[56] **References Cited**

U.S. PATENT DOCUMENTS

D. 323,826	2/1992	Suzuki et al.	D14/137
D. 346,756	5/1994	Grasso	D14/159
D. 358,147	5/1995	Siddoway et al.	D14/137
D. 376,764	12/1996	Barnes	D10/104
D. 379,092	5/1997	Richards et al.	D14/137
D. 380,749	7/1997	Richards et al.	D14/137
D. 387,758	12/1997	Oross et al.	D14/137
D. 389,827	1/1998	Oross et al.	D14/137
D. 398,923	9/1998	Tokiyama et al.	D14/137
D. 400,203	10/1998	Kolinen	D14/138
D. 409,997	5/1999	Heuel	D14/137

D. 416,252	11/1999	Haase et al.	D14/137
D. 416,893	11/1999	Tyneski et al.	D14/137
D. 418,137	12/1999	Zeitman	D14/194
D. 418,833	1/2000	Seo	D14/137
D. 419,154	1/2000	Page et al.	D14/137
D. 419,992	2/2000	Kolinen	D14/138
D. 421,002	2/2000	Davidson et al.	D14/137

OTHER PUBLICATIONS

Korean Design Reg. Publication, Reg. No. 148408, Publ. No. 1201, Reg. Date Feb. 7, 1994.

Korean Design Reg. Publication, Reg. No. 190604, Publ. No. 1487, Reg. Date Dec. 18, 1996.

Primary Examiner—Jeffrey Asch
Attorney, Agent, or Firm—Dougherty & Troxell

[57] **CLAIM**

The ornamental design for a hand held transceiver, as shown and described.

DESCRIPTION

FIG. 1 is a perspective view of a hand held transceiver showing my design;

FIG. 2 is a front elevation view thereof;

FIG. 3 is a rear elevation view thereof;

FIG. 4 is a left side elevation view thereof;

FIG. 5 is a right side elevation view thereof;

FIG. 6 is a top plan view thereof; and,

FIG. 7 is a bottom plan view thereof.

1 Claim, 4 Drawing Sheets

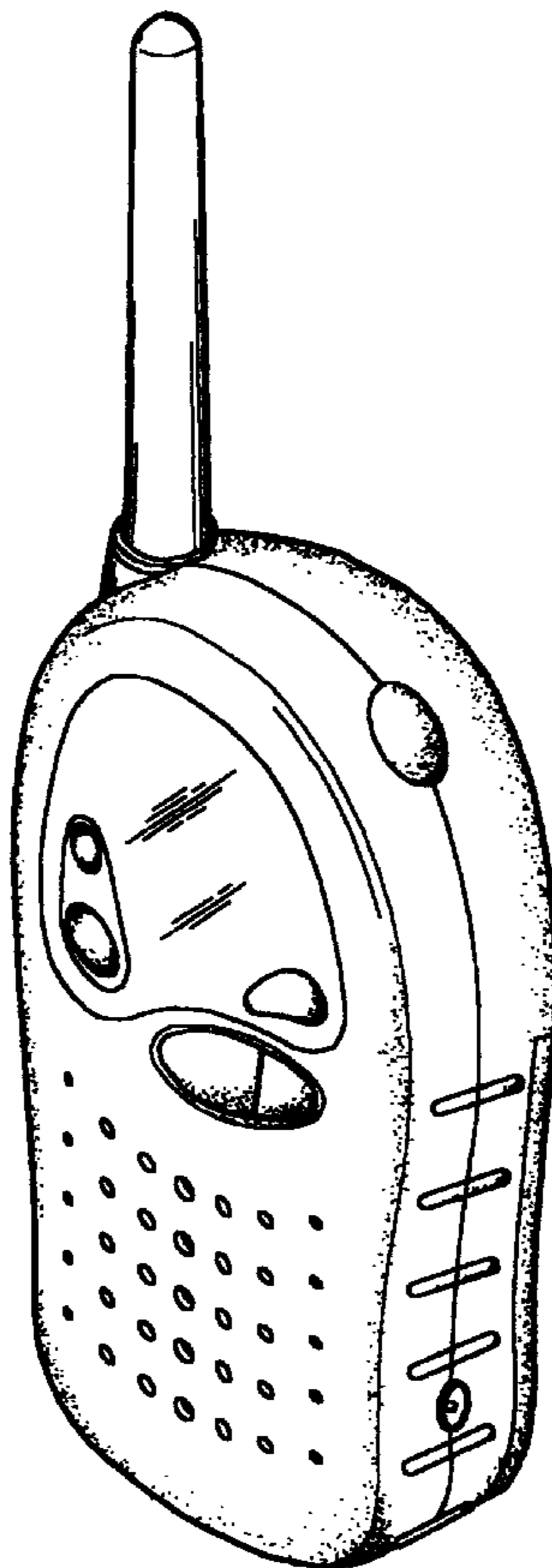

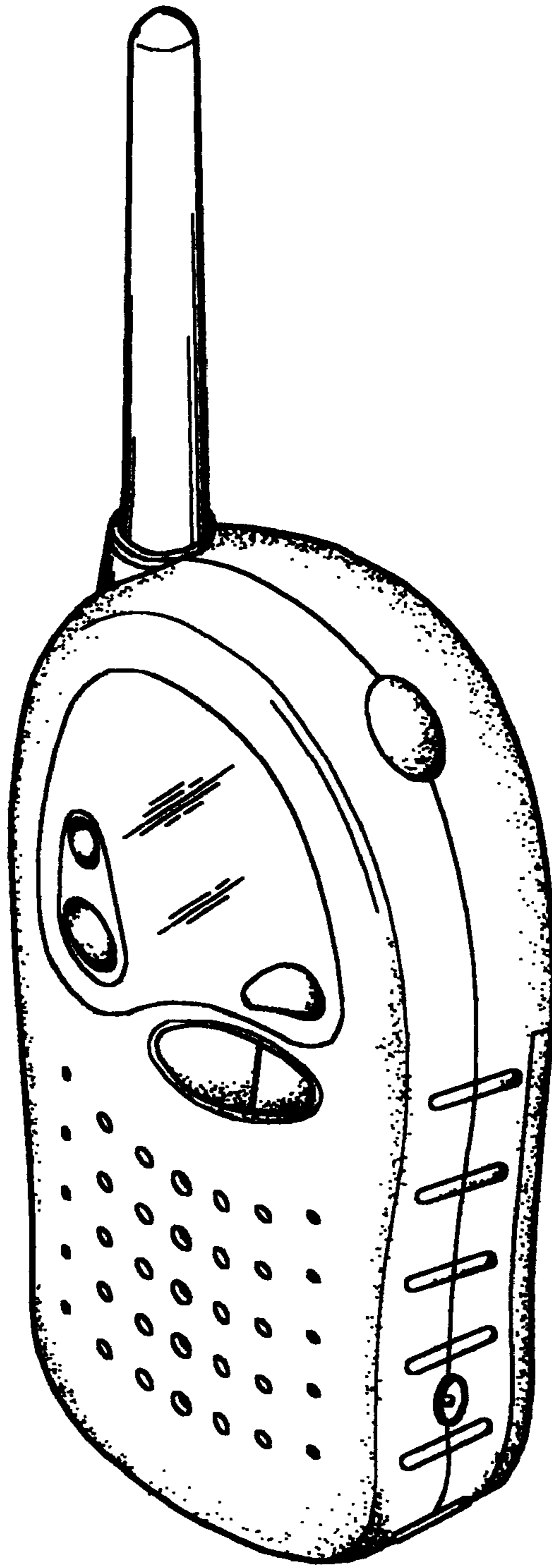

FIG. 1

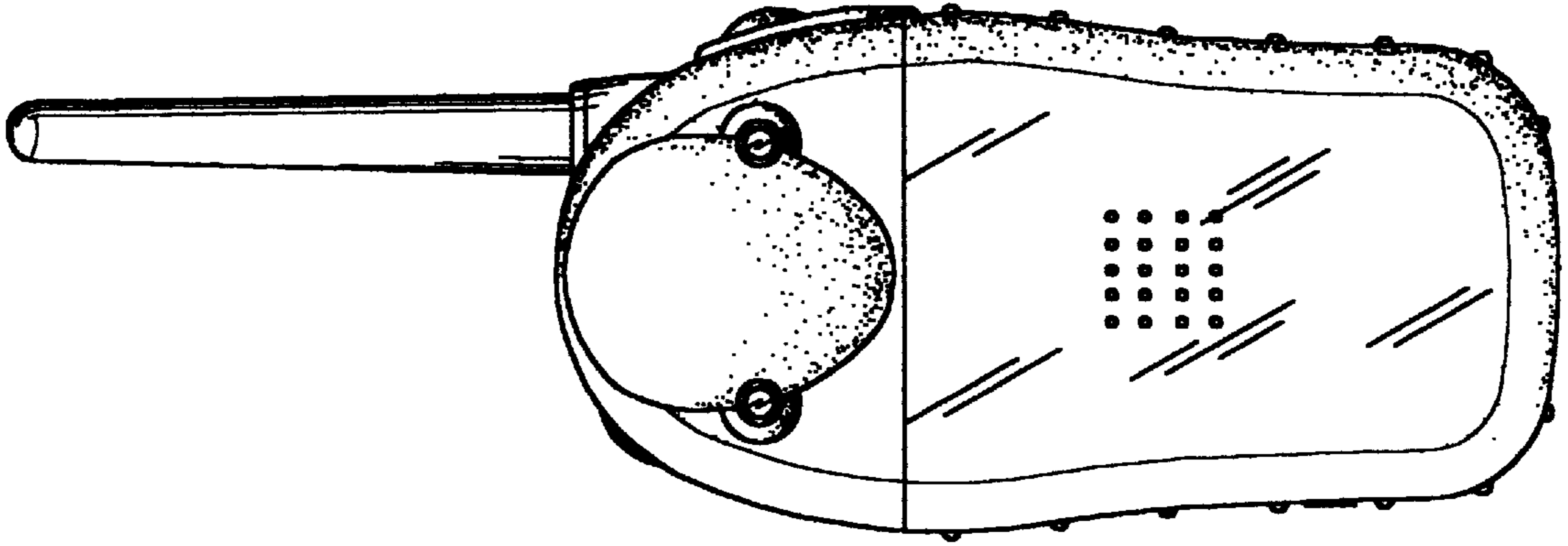

FIG.3

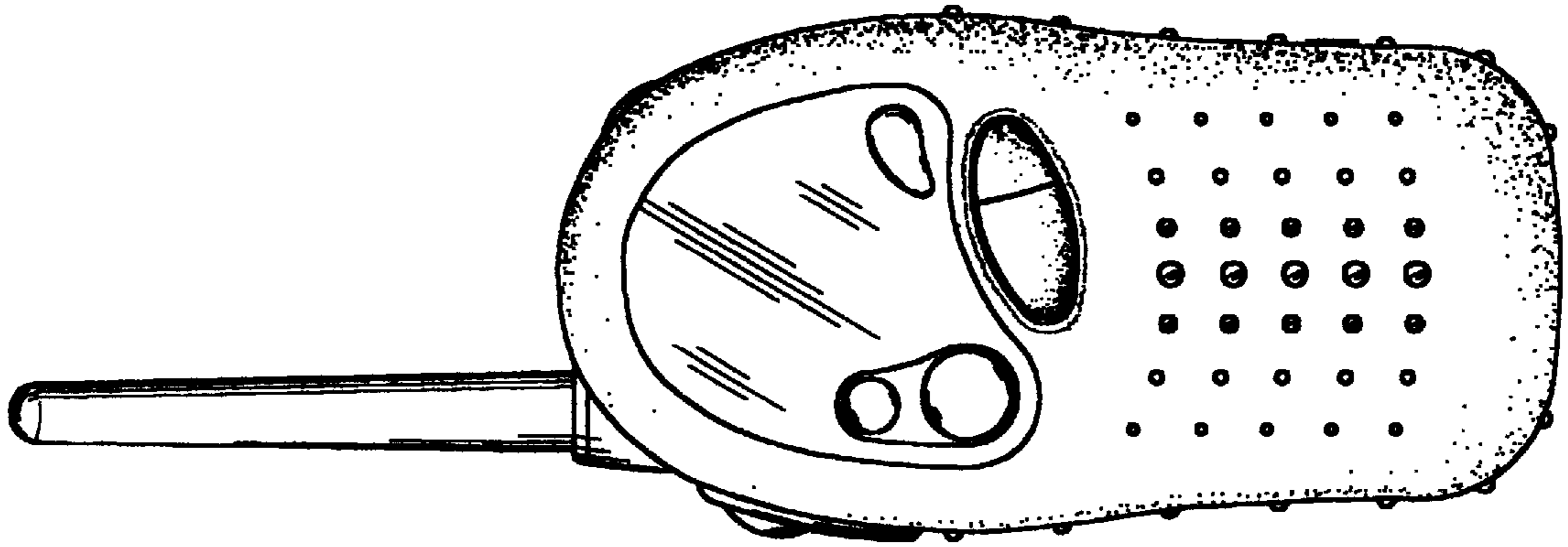

FIG.2

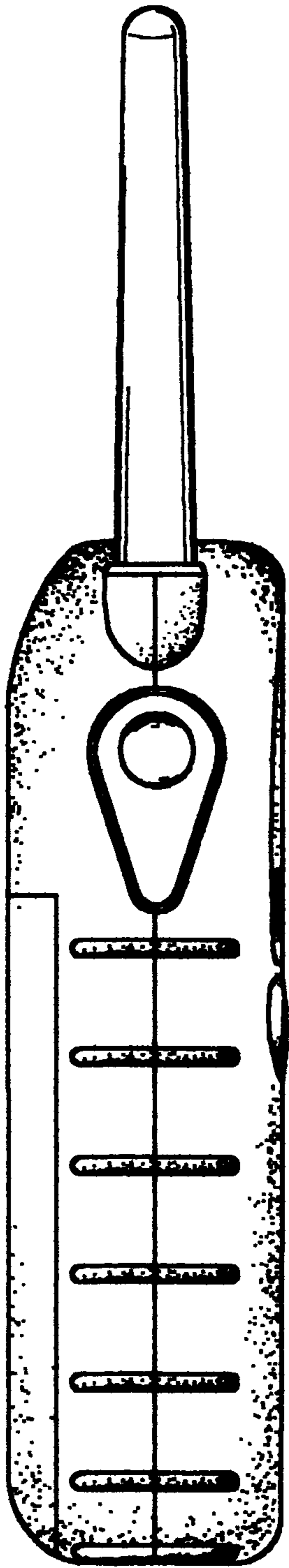

FIG. 4

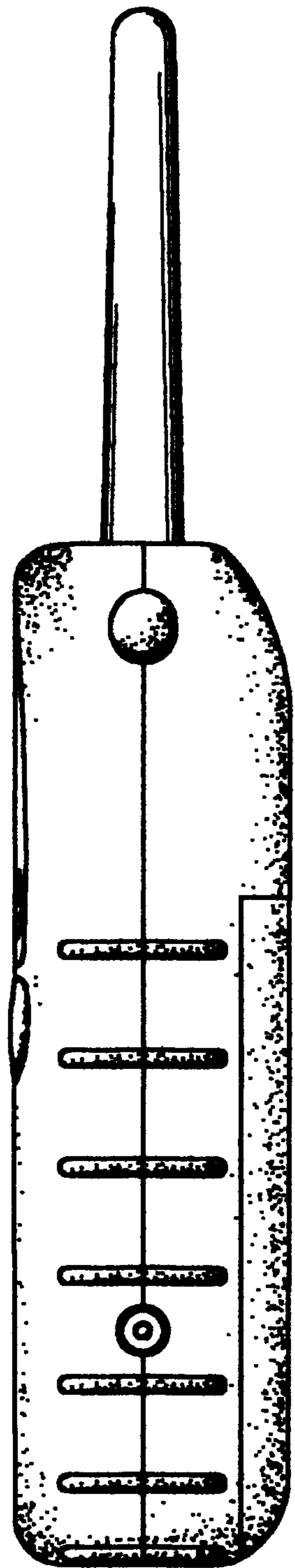

FIG. 5

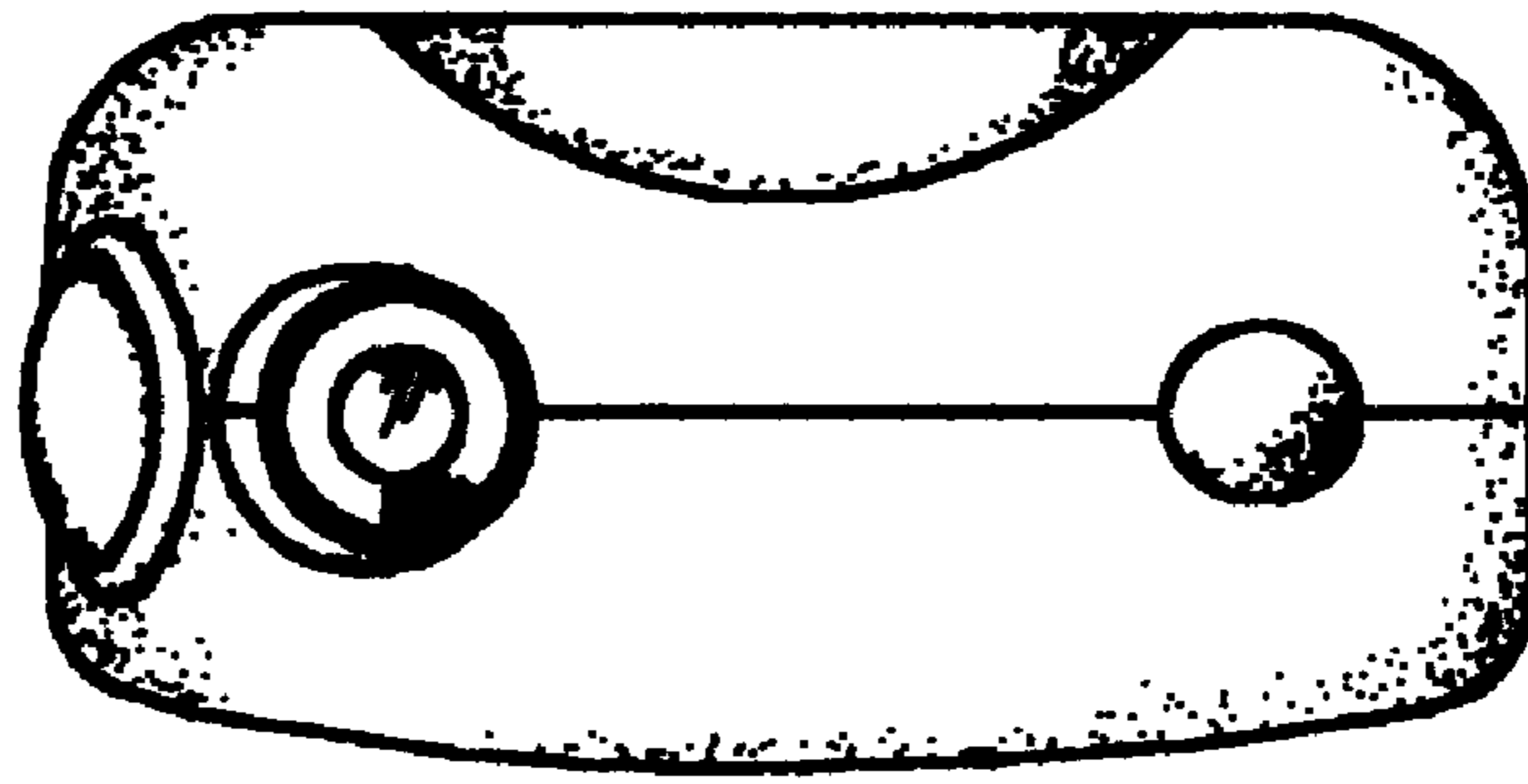

FIG. 6

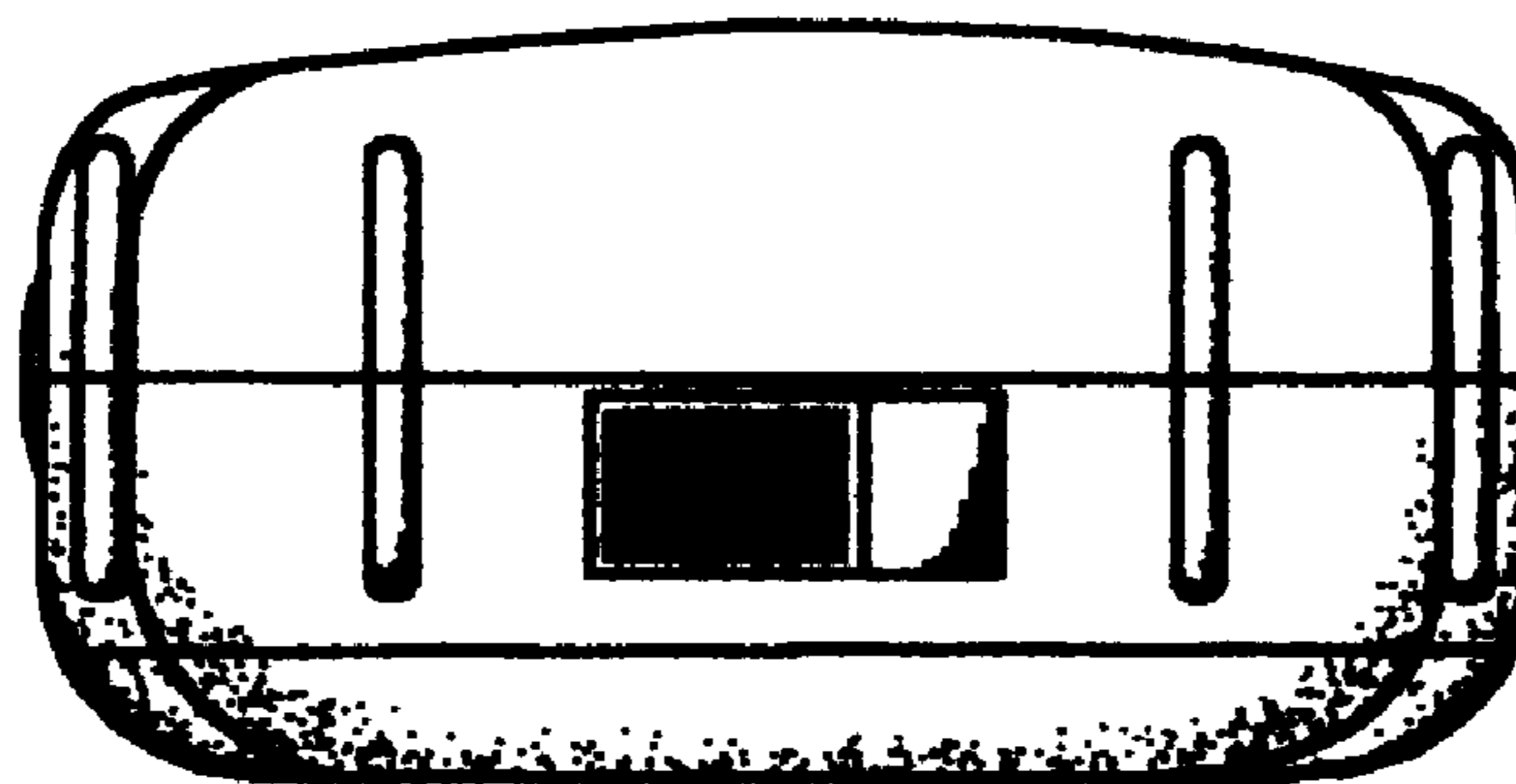

FIG. 7