



US00D428813S

United States Patent [19]
Haley

[11] **Patent Number: Des. 428,813**

[45] **Date of Patent: ** Aug. 1, 2000**

[54] **BEVERAGE CONTAINER**

Attorney, Agent, or Firm—Kinney & Lange, P.A.

[75] Inventor: **David O. Haley**, St. Paul, Minn.

[57] **CLAIM**

[73] Assignee: **Land O'Lakes, Inc.**, Arden Hills, Minn.

The ornamental design for a beverage container, as shown and described.

[**] Term: **14 Years**

DESCRIPTION

[21] Appl. No.: **29/110,200**

FIG. 1 is a front elevation of a beverage container showing my new design, the rear elevation is the same except for the threading on the neck;

[22] Filed: **Sep. 1, 1999**

FIG. 2 is a side elevation thereof, the opposite side elevation is the same except for the threading on the neck;

[51] **LOC (7) Cl.** **09-01**

FIG. 3 is a top view thereof;

[52] **U.S. Cl.** **D9/500; D9/520; D9/538**

FIG. 4 is a bottom view thereof;

[58] **Field of Search** D9/500, 503, 538, D9/539, 520, 504; 215/382, 383, 384

FIG. 5 is a side elevation of a second embodiment of the beverage container, the opposite side elevation is the same except for the threading on the neck;

[56] **References Cited**

FIG. 6 is a front elevation of the second embodiment, the rear elevation is the same except for the threading on the neck;

U.S. PATENT DOCUMENTS

D. 240,018	5/1976	Reynolds	D9/538
D. 247,847	5/1978	Kretz	D9/500
D. 308,575	6/1990	Mariol	D9/500
D. 384,889	10/1997	Nasrallah	D9/538

FIG. 7 is a top view thereof; and,

FIG. 8 is a bottom view thereof.

Primary Examiner—Lucy Lieberman

1 Claim, 6 Drawing Sheets

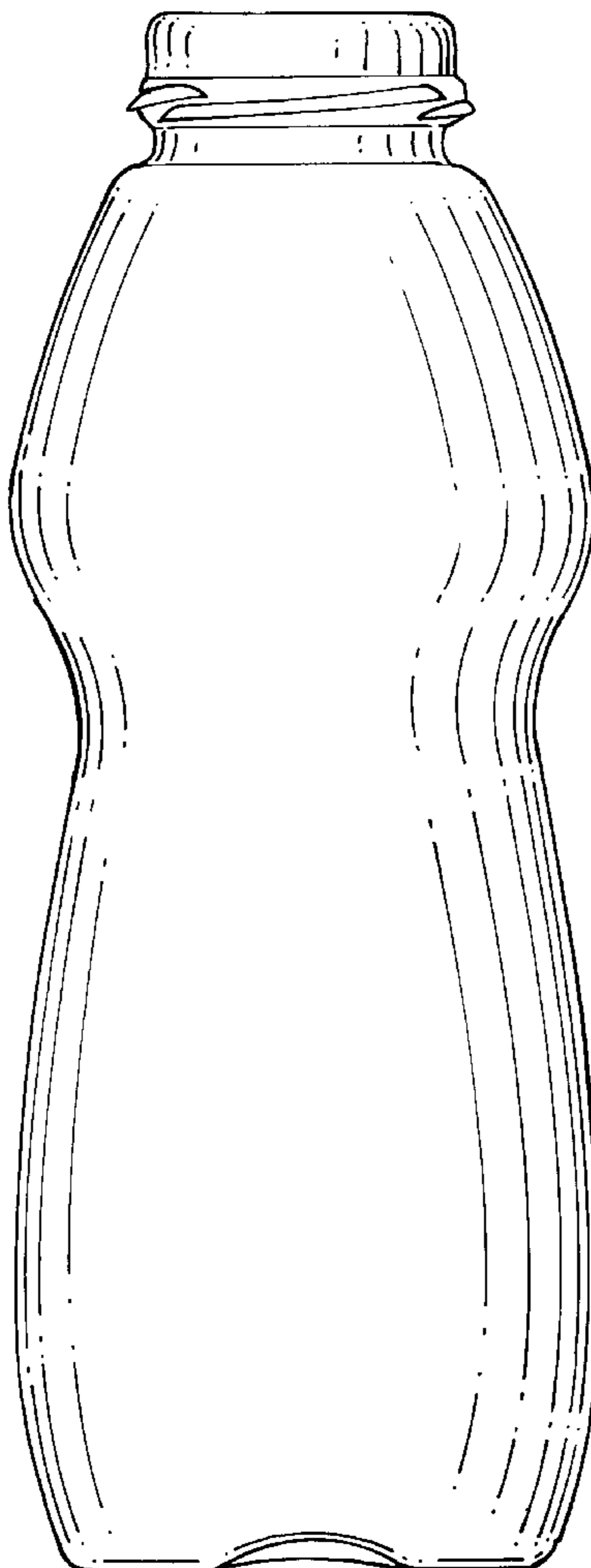

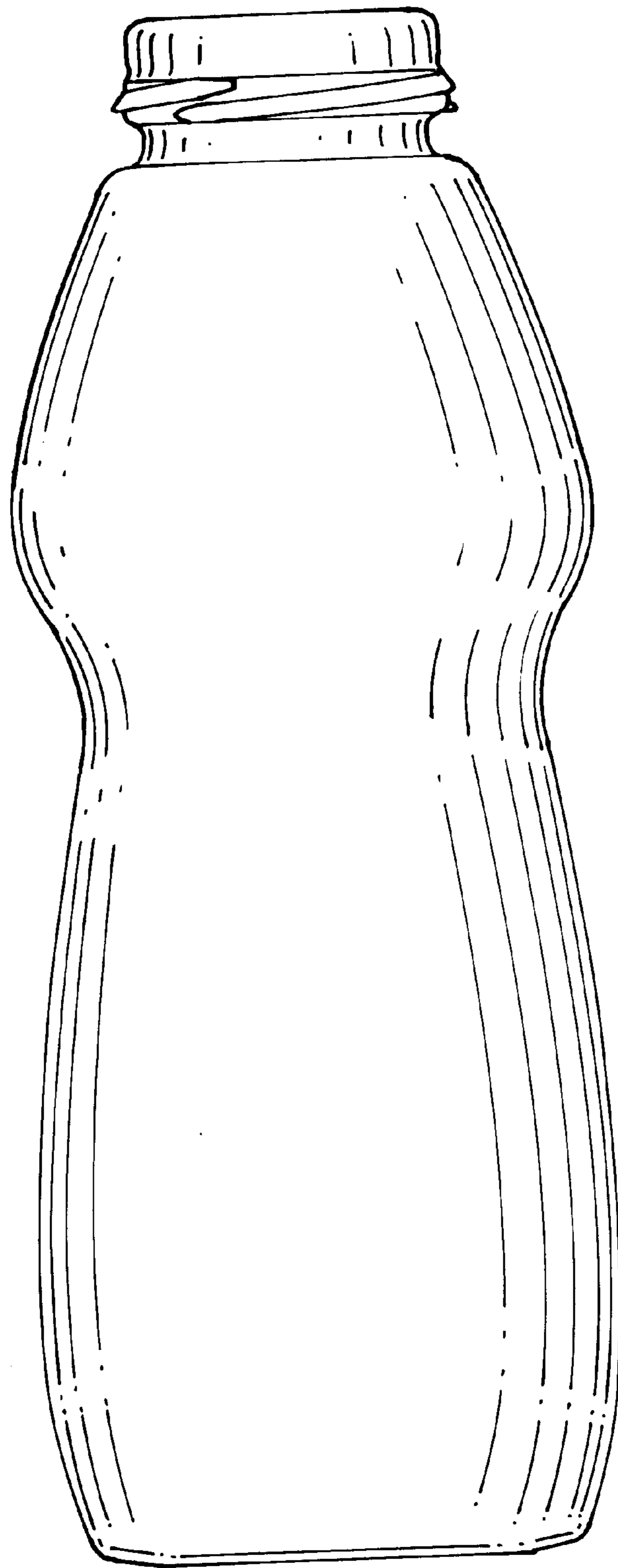

Fig. 1

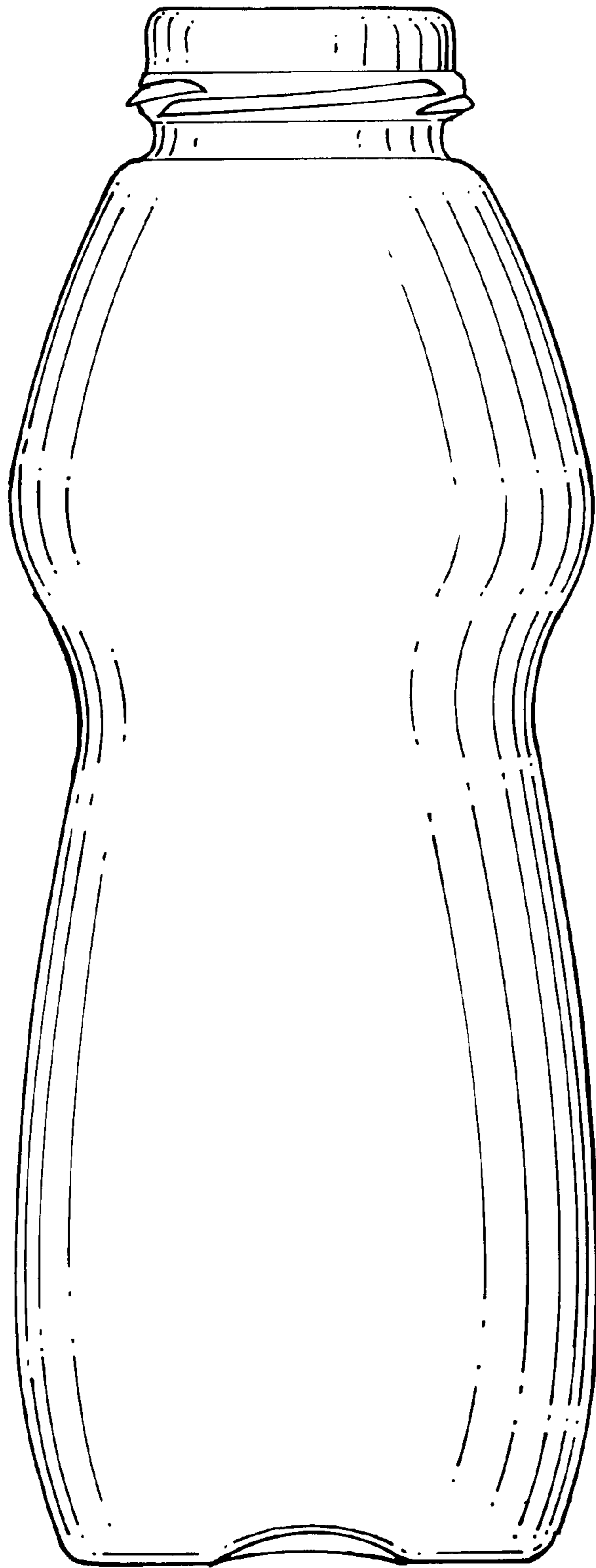

Fig. 2

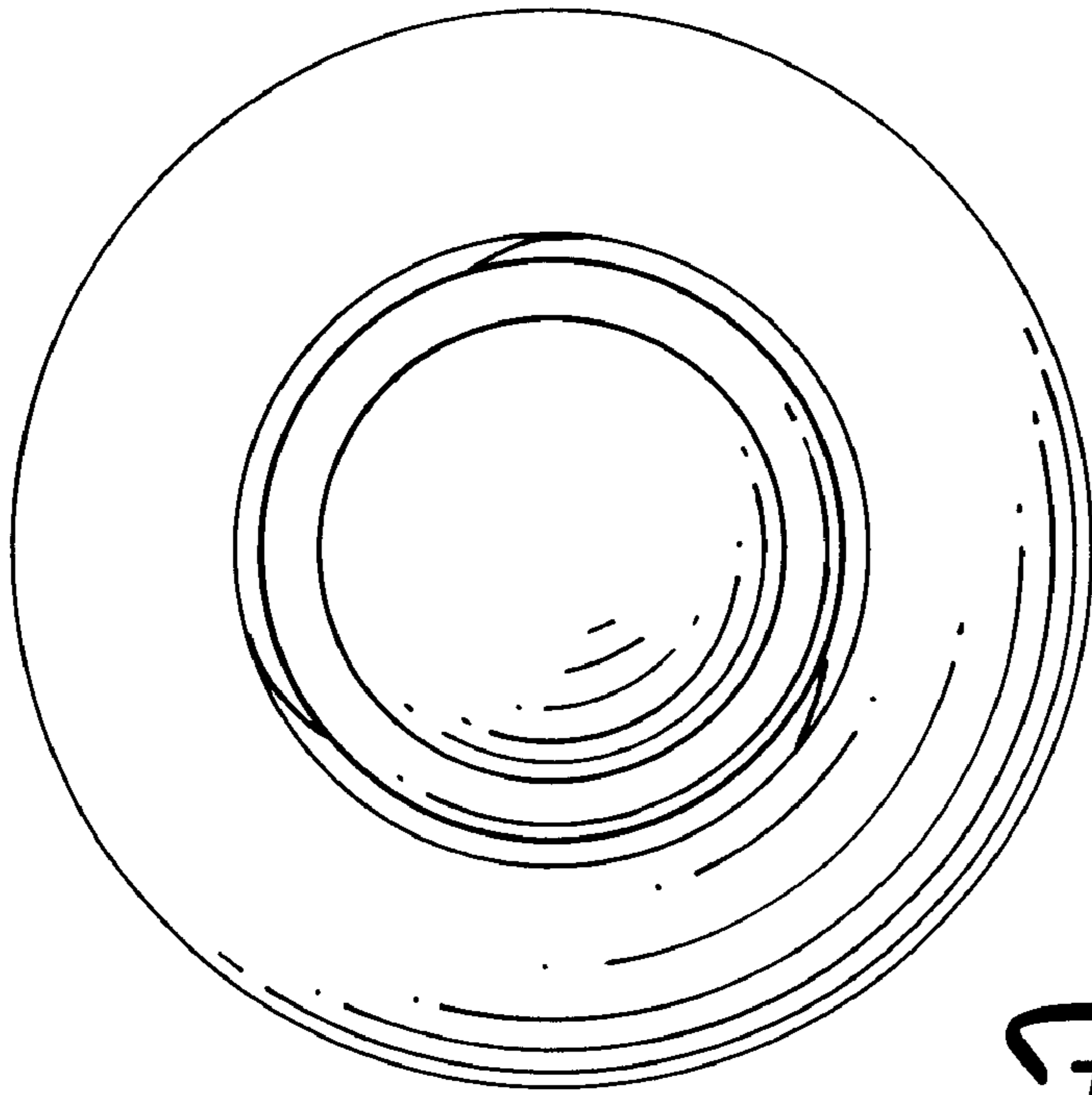

Fig. 3

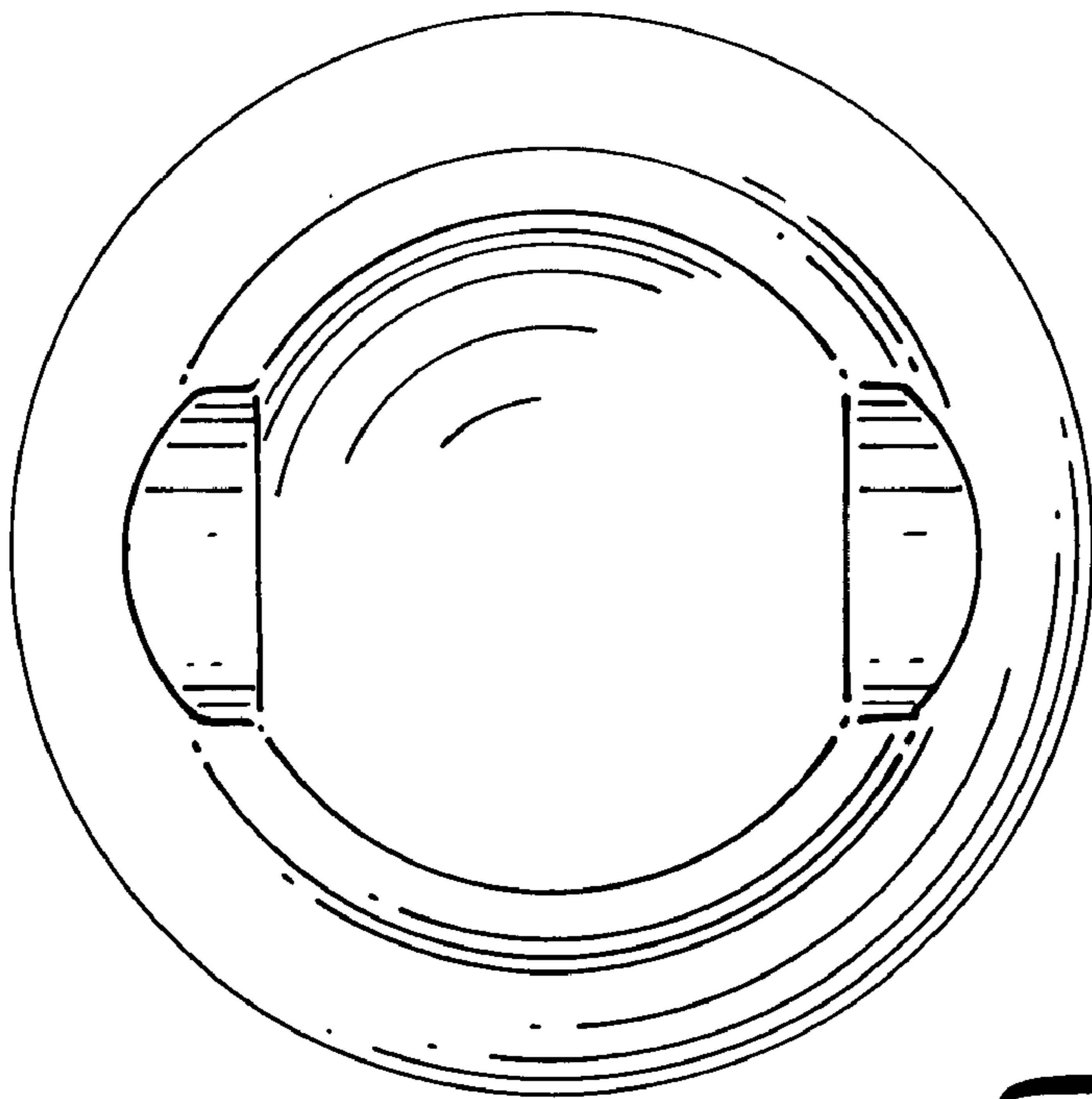

Fig. 4

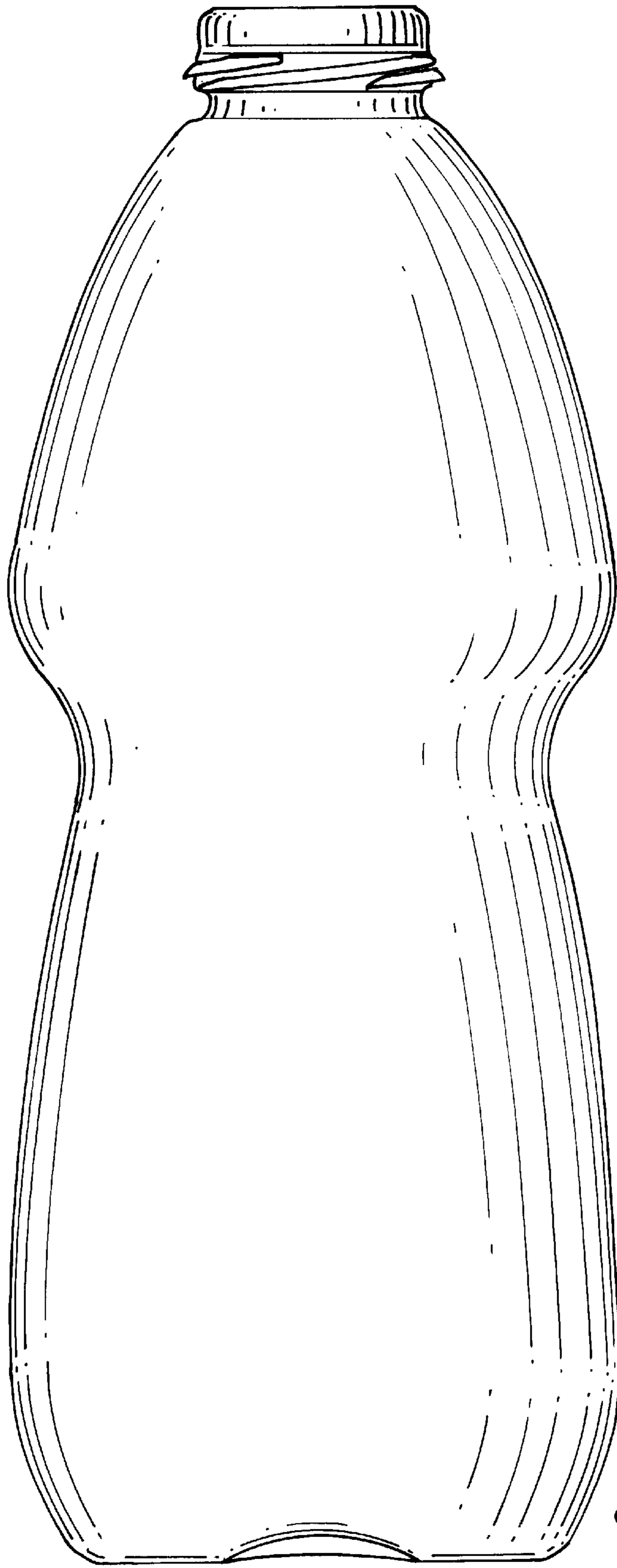

Fig. 5

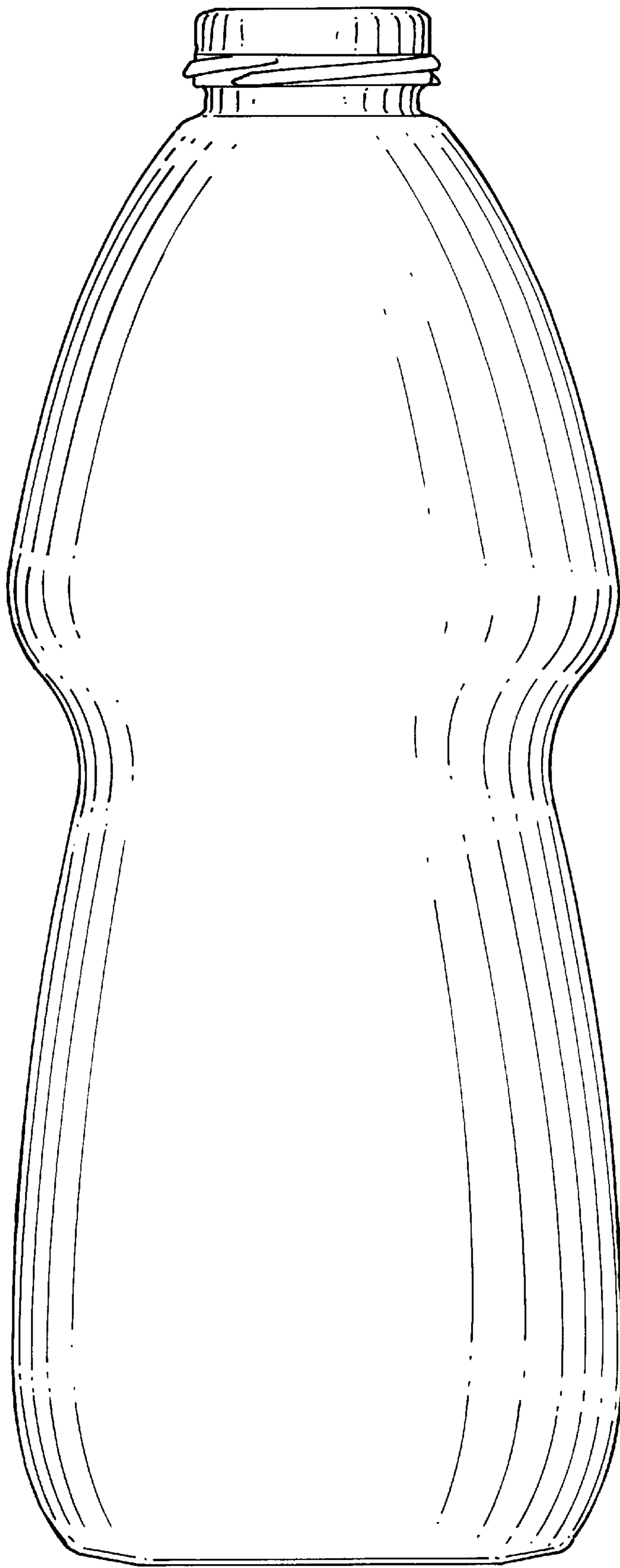

Fig. 6

Fig. 7

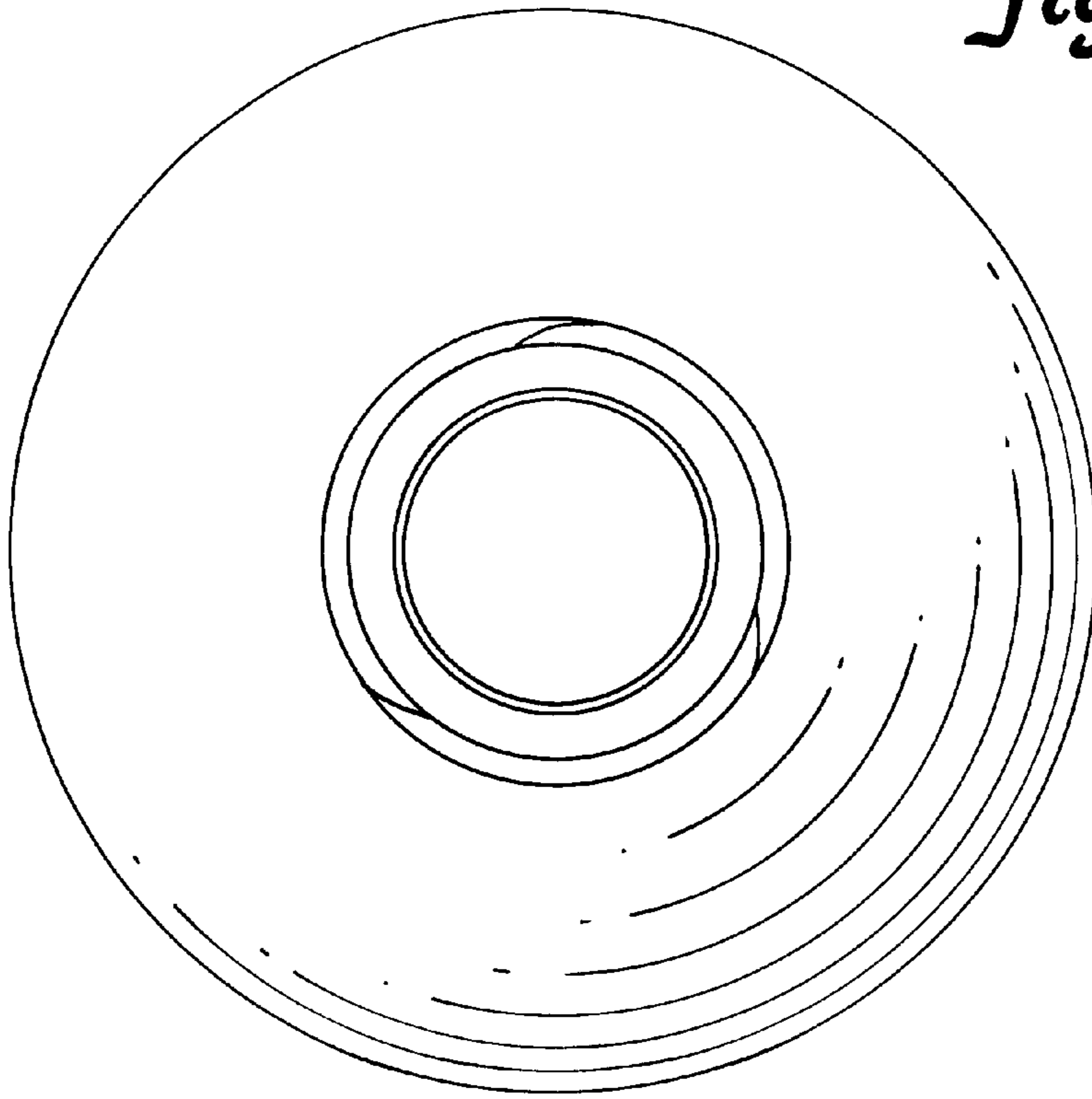

Fig. 8

