



US00D428783S

# United States Patent [19]

Precetti et al.

[11] Patent Number: Des. 428,783

[45] Date of Patent: \*\* Aug. 1, 2000

[54] CONTAINER OPENING TOOL

[75] Inventors: **Cyrille J. Precetti; Michael E. Hartman**, both of Des Moines, Iowa

[73] Assignee: **Pioneer Hi-Bred International, Inc.**, Johnston, Iowa

[\*\*] Term: **14 Years**

[21] Appl. No.: **29/111,792**

[22] Filed: **Oct. 5, 1999**

[51] LOC (7) Cl. .... **07-99**

[52] U.S. Cl. .... **D8/40**

[58] Field of Search ..... D8/33-43, 18, D8/19, 14, 16, 17, 88, 89; 30/400-443; 81/3.07-3.49, 45; 7/151-156; D7/688

[56] **References Cited**

**U.S. PATENT DOCUMENTS**

D. 32,486	4/1900	Searls	.....	D8/89	X
D. 148,500	1/1948	Travis	.....	D8/37	
D. 222,659	11/1971	Hillis	.....	D8/40	
D. 240,497	7/1976	Riba	.....	D8/40	X
D. 252,849	9/1979	Weiss	.....	D8/18	
D. 282,712	2/1986	Rademacher	.....	D8/14	
D. 303,344	9/1989	Broadus	.....	D8/40	
D. 319,954	9/1991	Able et al.	.....	D8/18	

D. 344,551	2/1994	McJunkin	.....	D21/399	
D. 390,434	2/1998	Aguero et al.	.....	D8/40	
D. 393,195	4/1998	Rose, III	.....	D8/89	
D. 395,215	6/1998	Siemion et al.	.....	D8/40	
D. 395,990	7/1998	Willis	.....	D8/41	
D. 417,600	12/1999	Heatwole	.....	D8/88	
602,324	4/1898	Hautsch	.....	D7/688	
3,987,827	10/1976	Mills	.....	81/45	
4,509,242	4/1985	Marra	.....	29/267	
5,069,090	12/1991	Clark	.....	81/3.09	
5,222,265	6/1993	Hermansson	.....	7/156	

*Primary Examiner*—Jeffrey Asch  
*Attorney, Agent, or Firm*—Zarley, McKee, Thomte, Voorhees & Sease

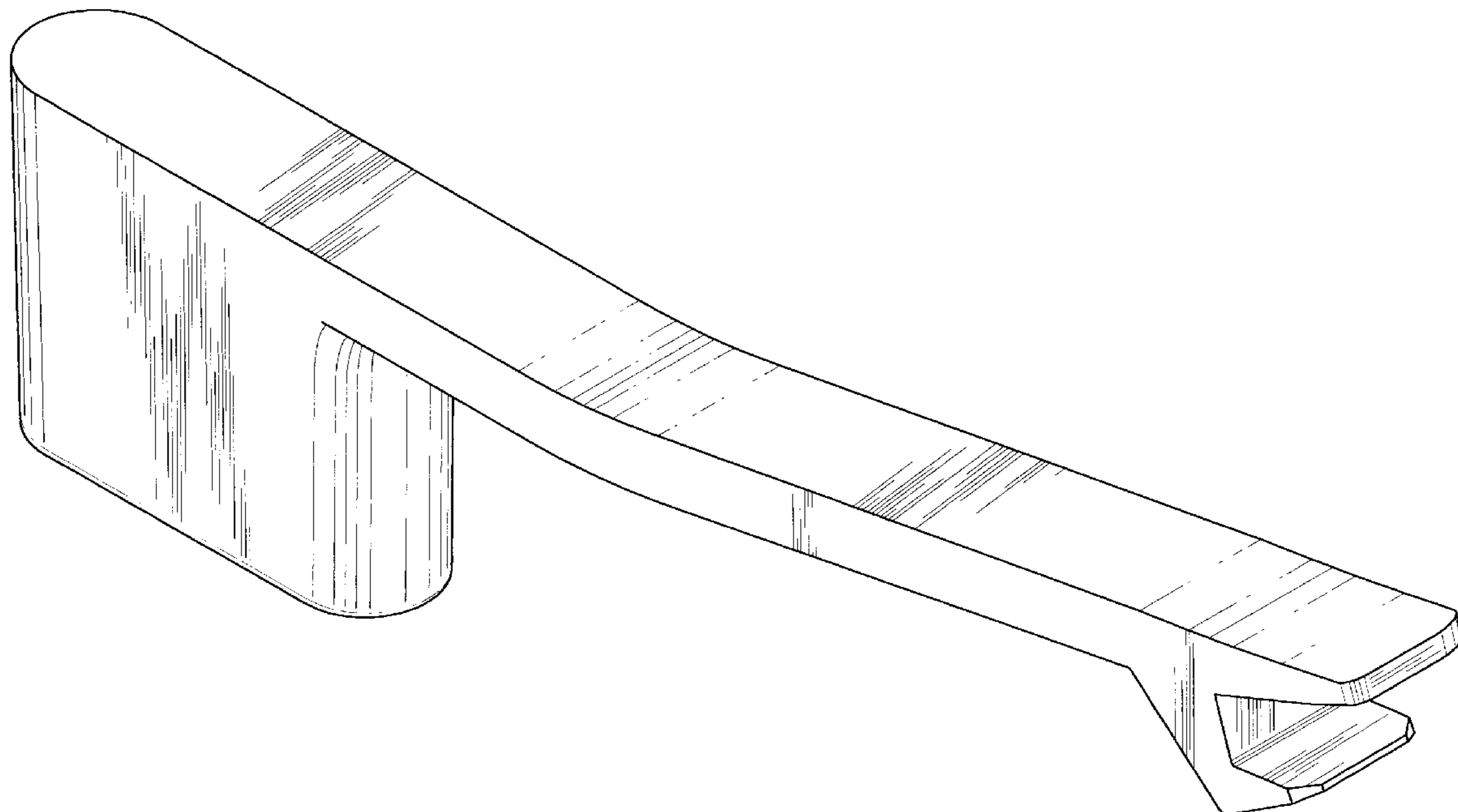
[57] **CLAIM**

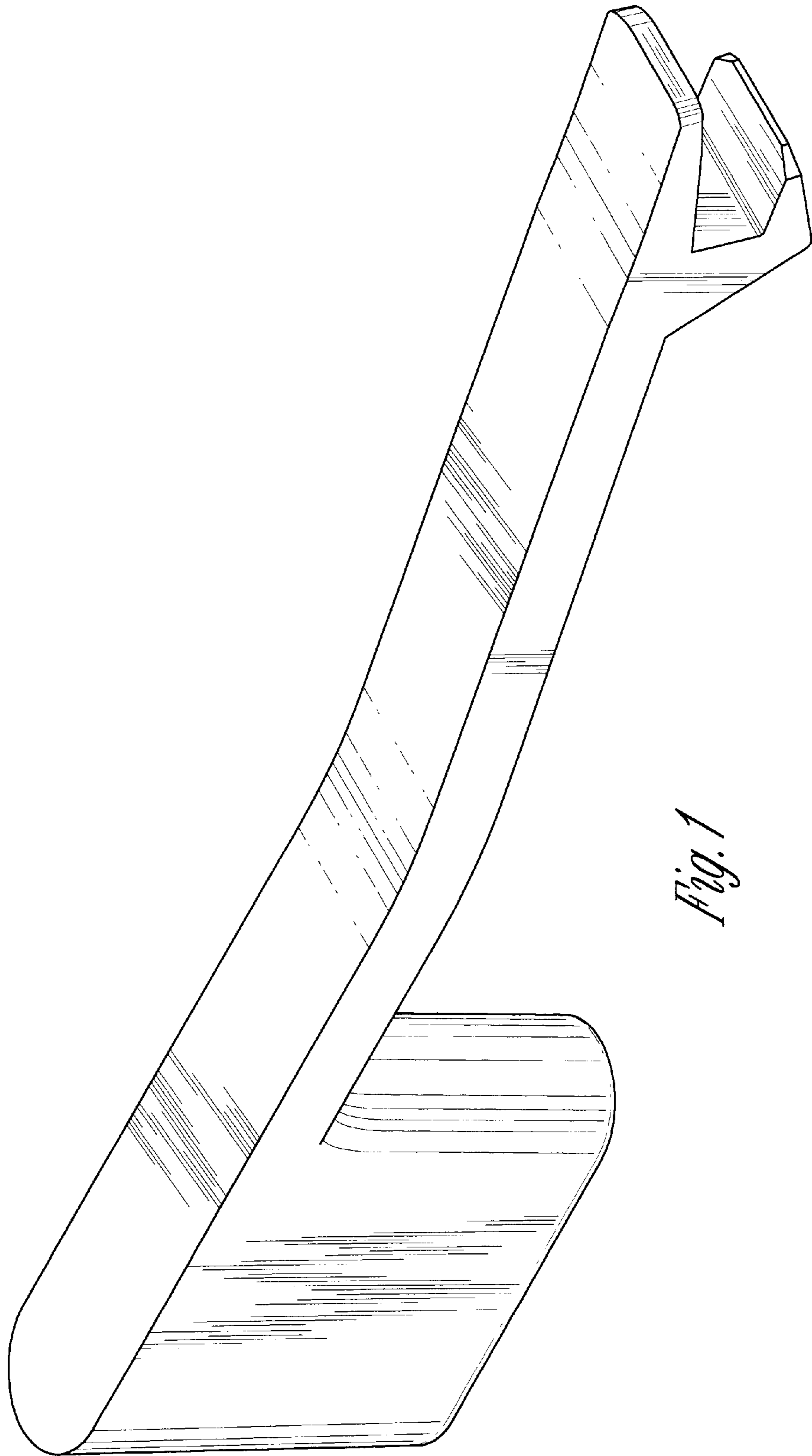
The ornamental design for a container opening tool, substantially as shown and described.

**DESCRIPTION**

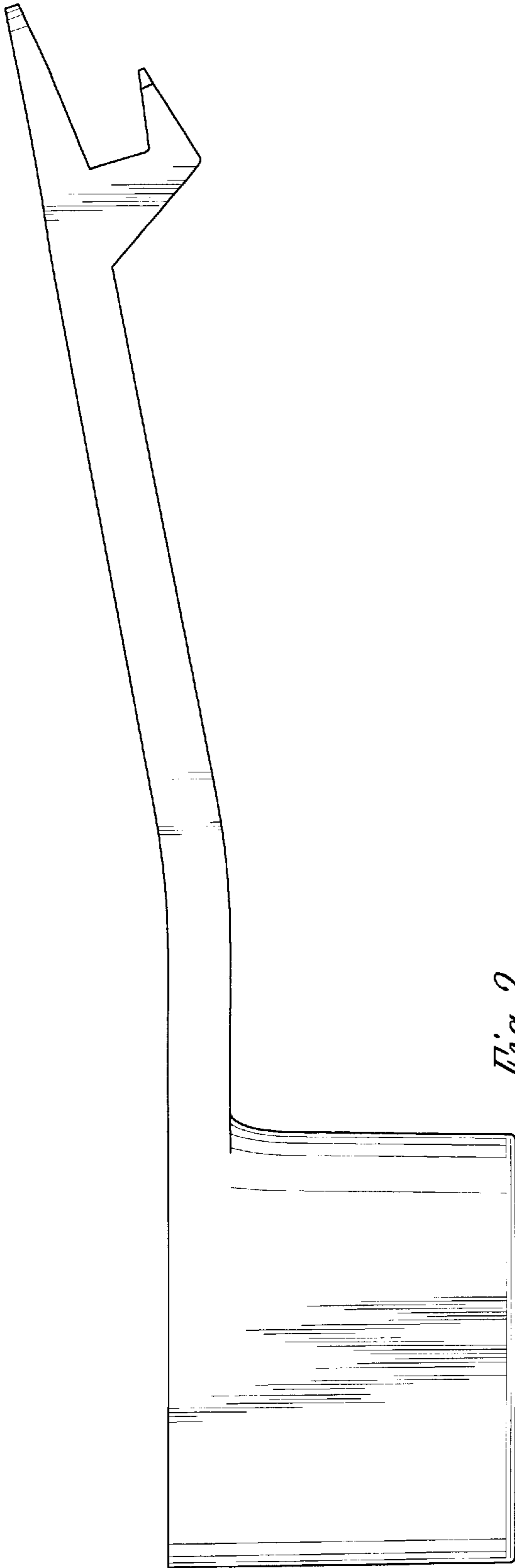
FIG. 1 is a perspective view of the invention.  
FIG. 2 is a side elevational view of FIG. 1, the opposited side is a mirror image thereof.  
FIG. 3 is a bottom plan view of FIG. 1.  
FIG. 4 is a top plan view of FIG. 1.  
FIG. 5 is a left end elevational view of FIG. 1; and,  
FIG. 6 is a right end elevational view of FIG. 1.

**1 Claim, 3 Drawing Sheets**

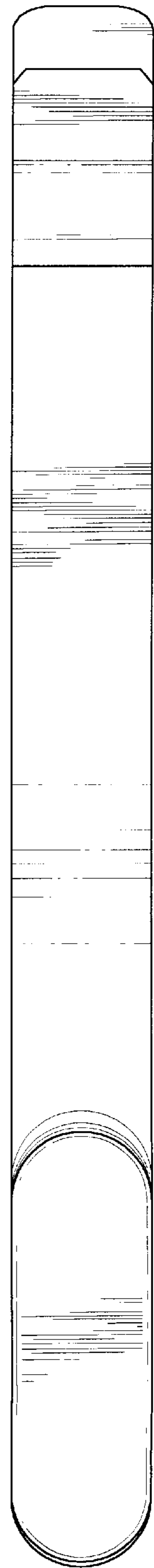




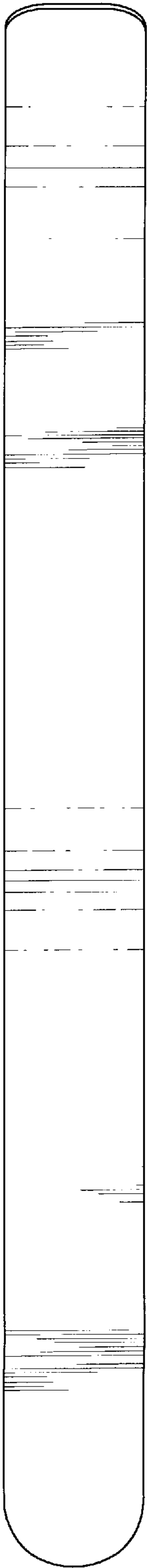
*Fig. 1*



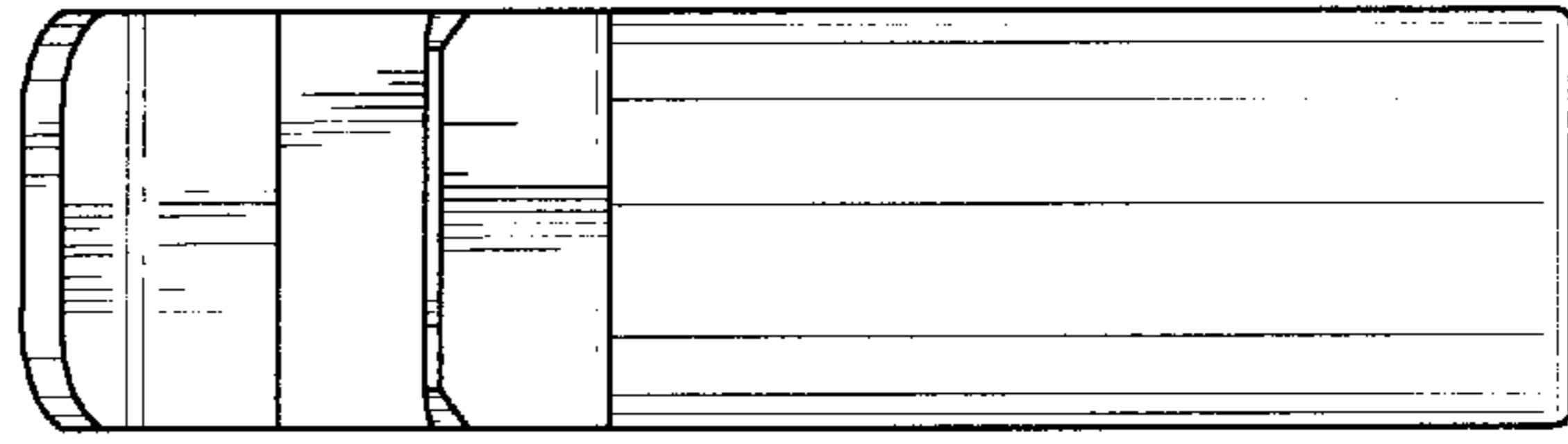
*Fig. 2*



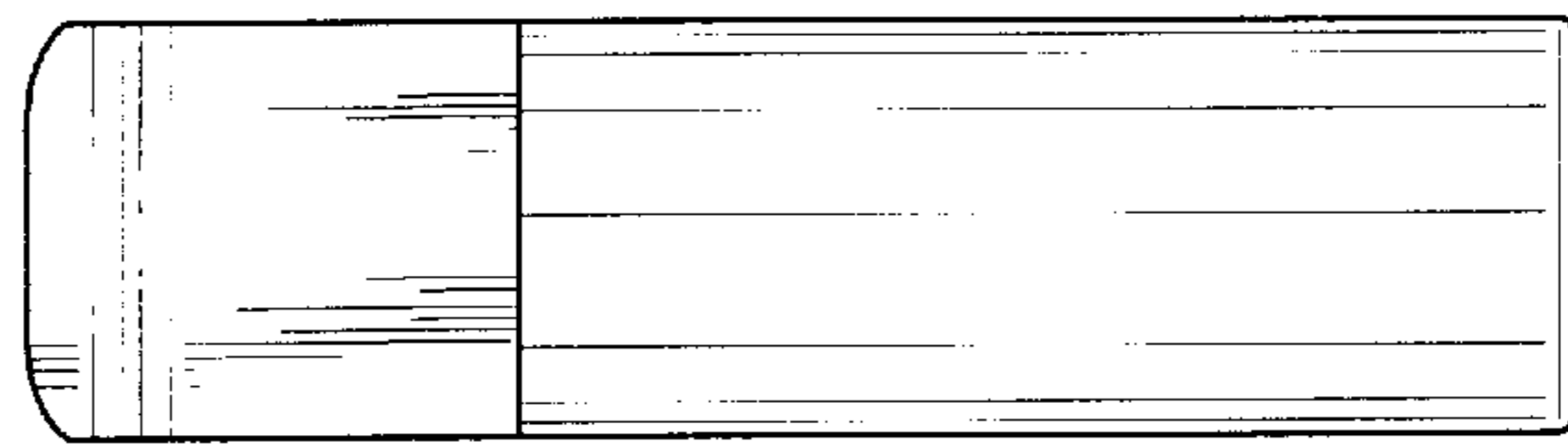
*Fig. 3*



*Fig. 4*



*Fig. 6*



*Fig. 5*